

Excellence in Operations



Affordable Price



Unswerving Quality



Unbeatable Services

Special Features of our Lap Instruments

- **Extensive Selection of Laparoscopic Instruments for even the most complicated Minimally Invasive Procedures.**
- **Available in both Modular and single-piece configurations as well as standard and Bariatric Length(33/36/45cm)**
- **Fully Disassembled for Effective Cleaning and Contamination**

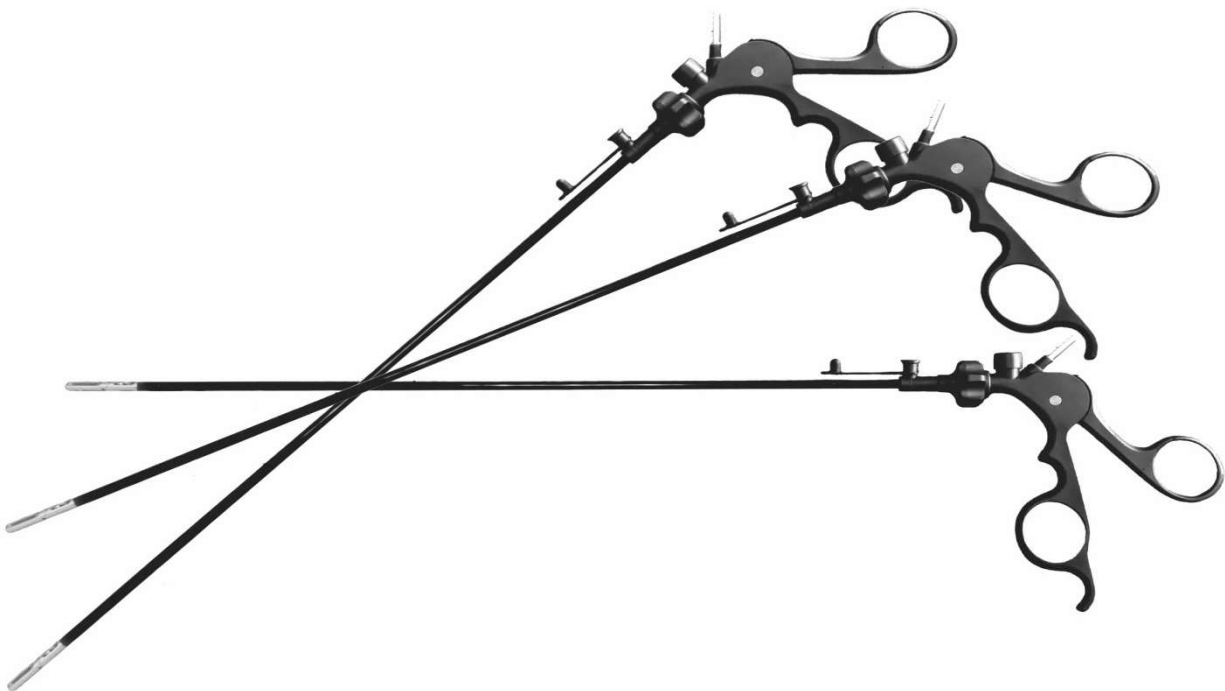

Laparoscopic Instruments

Laparoscope



Trocar and Sealing Cap

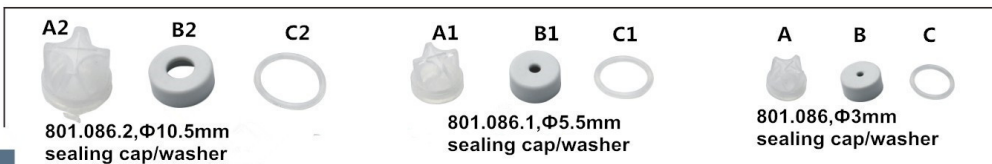
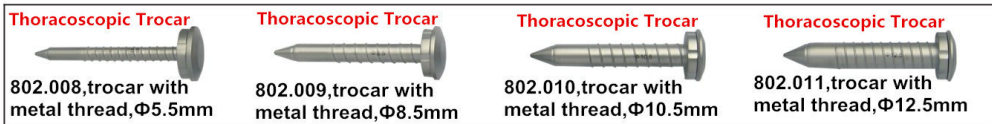
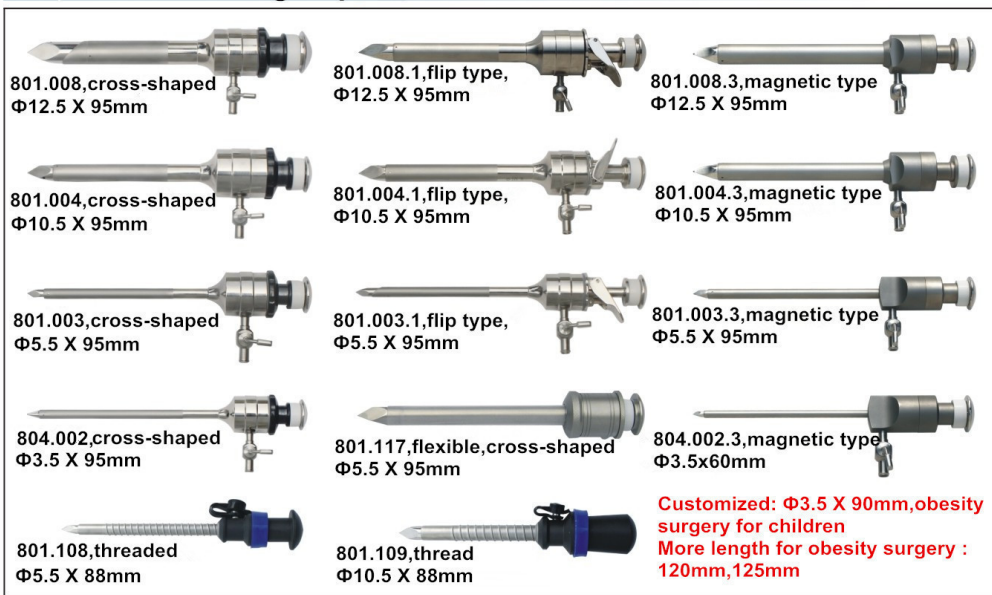

Customized Length:
 $\Phi 3.5 / \Phi 5.5 / \Phi 10.5 / \Phi 12.5 \times 90\text{mm} / 120\text{mm} / 125\text{mm}$

Laparoscopic Instruments

Reducer

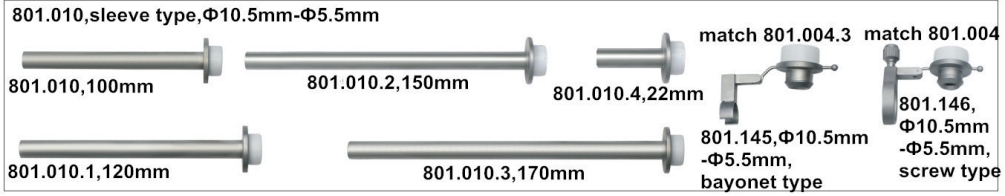

Veress Needle



Aspiration Needle

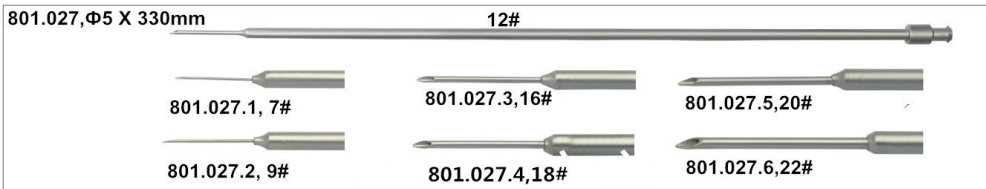

Bile Duct Knife

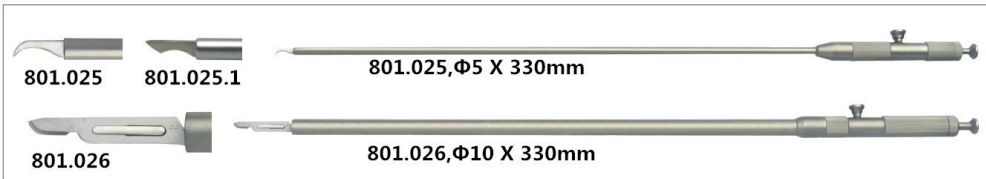

Monopolar HF Electrode-Electrode, monopolar, with insulated sheath, L-Hook



Customize Length:
5mmx360mm/410mm/430mm/440mm/450mm/460mm

Laparoscopic Instruments

Monopolar HF Electrode with S&I, $\Phi 5 \times 330\text{mm}$

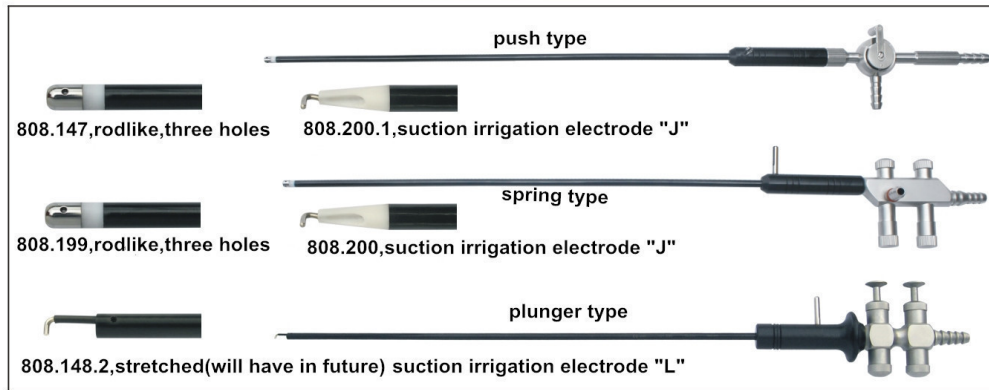

Monopolar Cable (Cord for Monopolar)

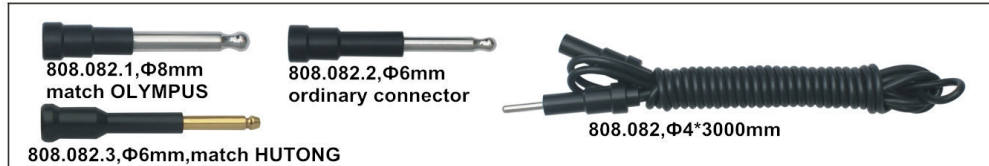

Suction Irrigation, $\Phi 5/\Phi 10 \times 330\text{mm}$

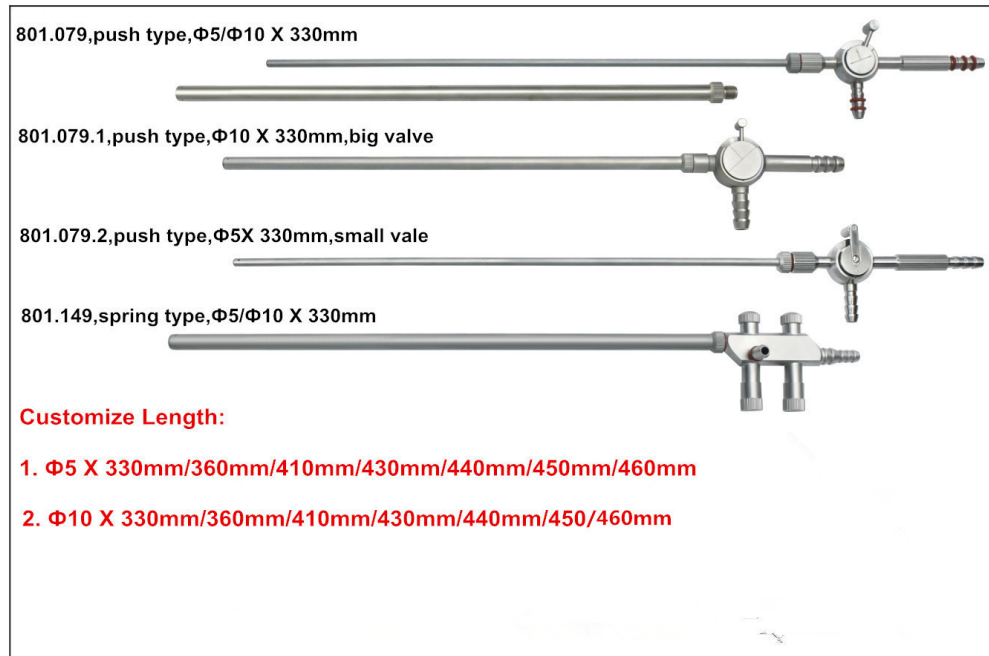

Laparoscopic Instruments

Bipolar and Cable, $\Phi 5 \times 330 \text{mm}$



Customize Length: $\Phi 5 \times 360 \text{mm}/410 \text{mm}/430 \text{mm}/440 \text{mm}/450 \text{mm}/460 \text{mm}$

All three part/partition

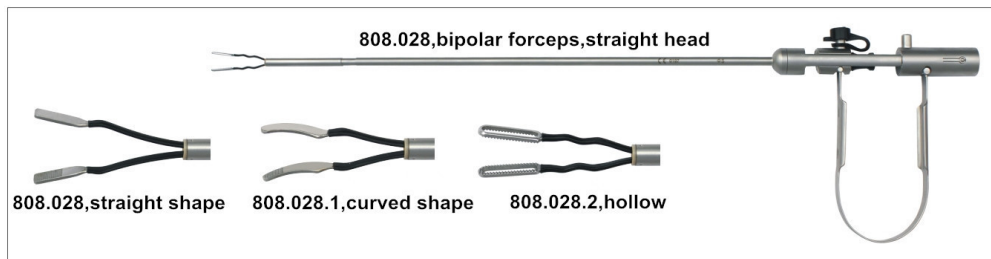
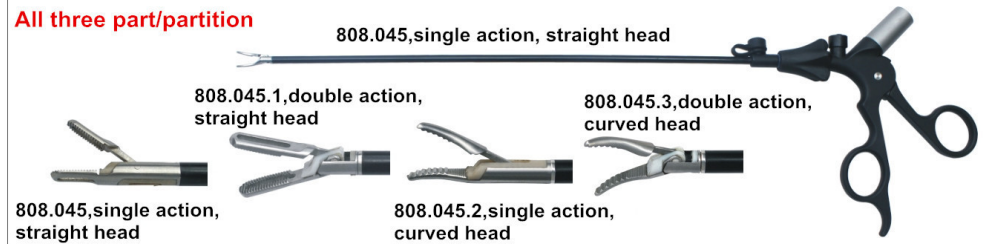

Customize Length:
5mmx360mm/410mm/430mm/440mm/450mm/460mm

Laparoscopic Instruments

Clip Applier, Polymer Ligation Clip/Hem-o-Lok Clips

801.113, XL, $\Phi 10$ X 330mm, matches 805.621

New Product: Articulated/Flexible Clip Applier, 801.114, $\Phi 10$ X 330mm, XL, match 805.621

801.113.1, L, $\Phi 10$ X 330mm, matches 805.622

New Product: Articulated/Flexible Clip Applier, 801.114.1, $\Phi 10$ X 330mm, L, match 805.622

801.113.2, S, $\Phi 5$ X 330mm, matches 805.623

805.621, XL 805.622, L 805.623, S

Clip Remover

801.131, L, $\Phi 10.5$ X 330mm

801.131.1, S, $\Phi 5.5$ X 330mm

Open Clip Applier (matches polymer ligation clips)

801.115, XL
matches 805.621

801.115.1, L
matches 805.622

801.115.2, S
matches 805.623

Laparoscopic Instruments

Titanium Clip Applier

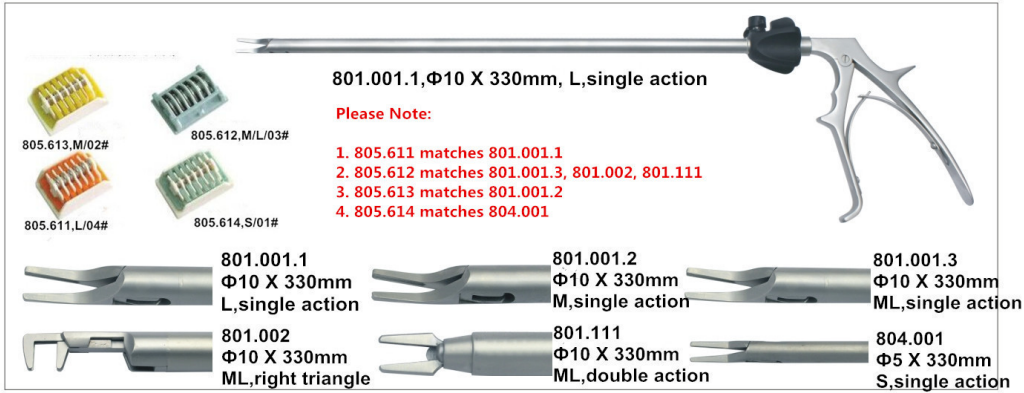

805.613,M/02# 805.612,M/L/03#
805.611,L/04# 805.614,S/01#

801.001.1, $\Phi 10$ X 330mm, L, single action

Please Note:

1. 805.611 matches 801.001.1
2. 805.612 matches 801.001.3, 801.002, 801.111
3. 805.613 matches 801.001.2
4. 805.614 matches 804.001

801.001.1 $\Phi 10$ X 330mm L, single action	801.001.2 $\Phi 10$ X 330mm M, single action	801.001.3 $\Phi 10$ X 330mm ML, single action
801.002 $\Phi 10$ X 330mm ML, right triangle	801.111 $\Phi 10$ X 330mm ML, double action	804.001 $\Phi 5$ X 330mm S, single action

Clip Applier

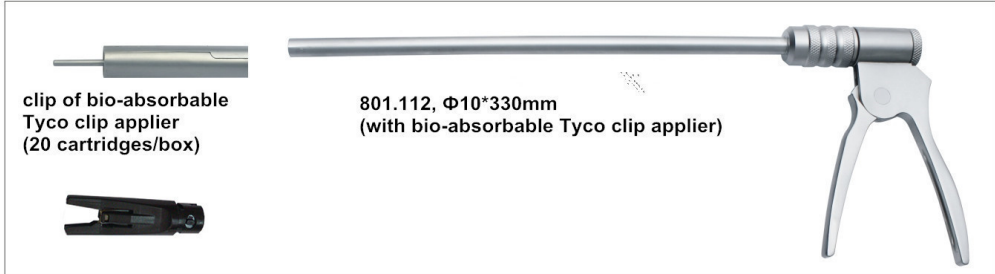

clip of bio-absorbable Tyco clip applier (20 cartridges/box)

801.112, $\Phi 10$ *330mm (with bio-absorbable Tyco clip applier)

Purse Stitching Clamp, open surgery

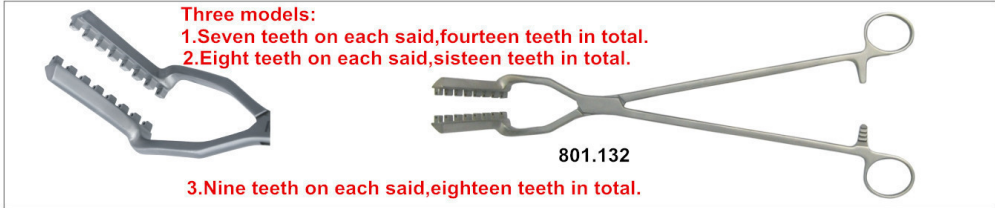

Three models:

1. Seven teeth on each said, fourteen teeth in total.
2. Eight teeth on each said, sixteen teeth in total.
3. Nine teeth on each said, eighteen teeth in total.

801.132

Artery Vein Clip/Bull Dog Clamp

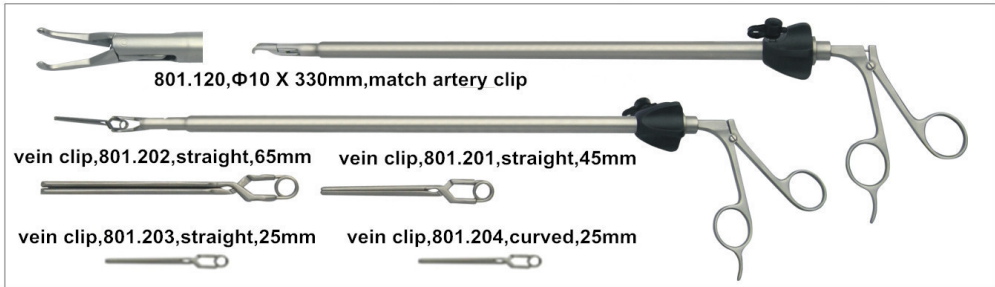

801.120, $\Phi 10$ X 330mm, match artery clip

vein clip, 801.202, straight, 65mm vein clip, 801.201, straight, 45mm

vein clip, 801.203, straight, 25mm vein clip, 801.204, curved, 25mm

**Customize Length:
5mm/10mmx360mm/410mm/430mm/440mm/450mm/460mm**

Laparoscopic Instruments

Needle Holder, $\Phi 5 \times 330\text{mm}$

O-shaped



V-shaped, light



V-shaped, heavy

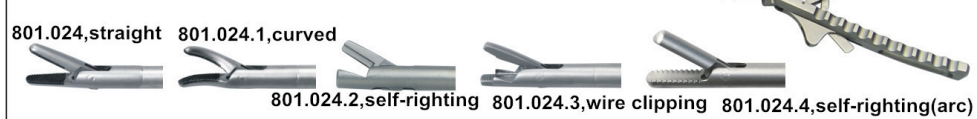

Gun shaped

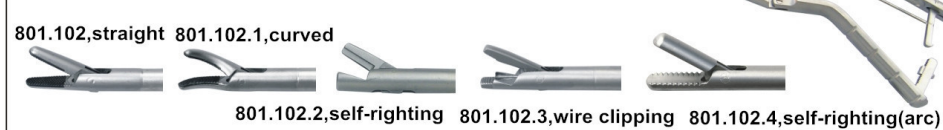

Closure & Hernia Suture Retriever

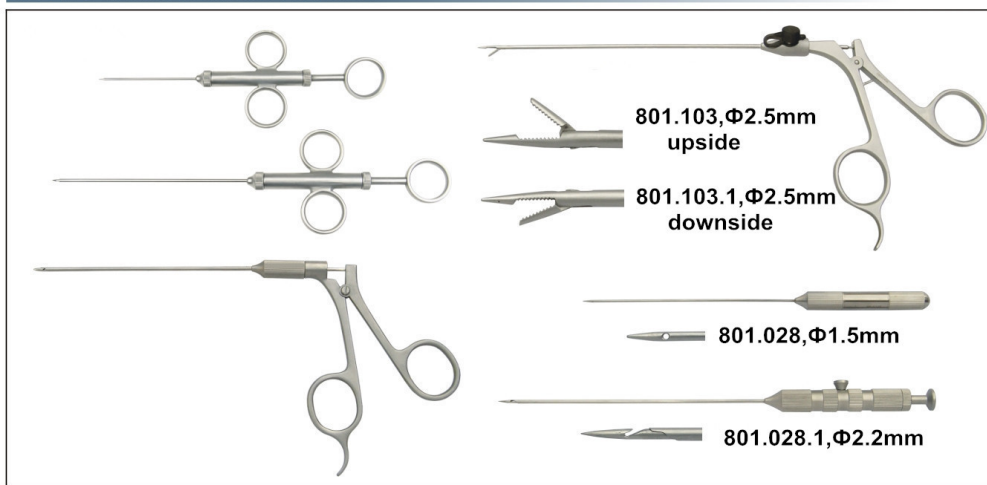

Laparoscopic Instruments

Knot Pusher, $\Phi 5 \times 330\text{mm}$

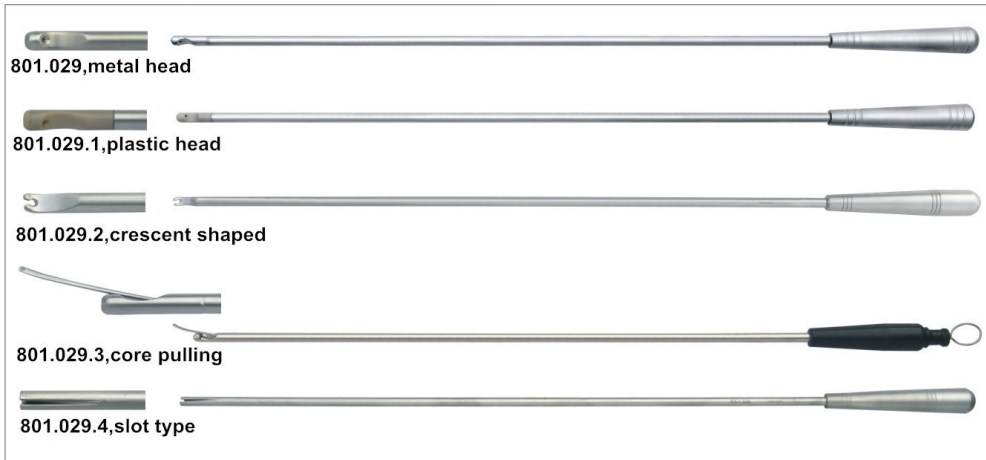

Three Leaves Retractor and Five Leaves Retractor

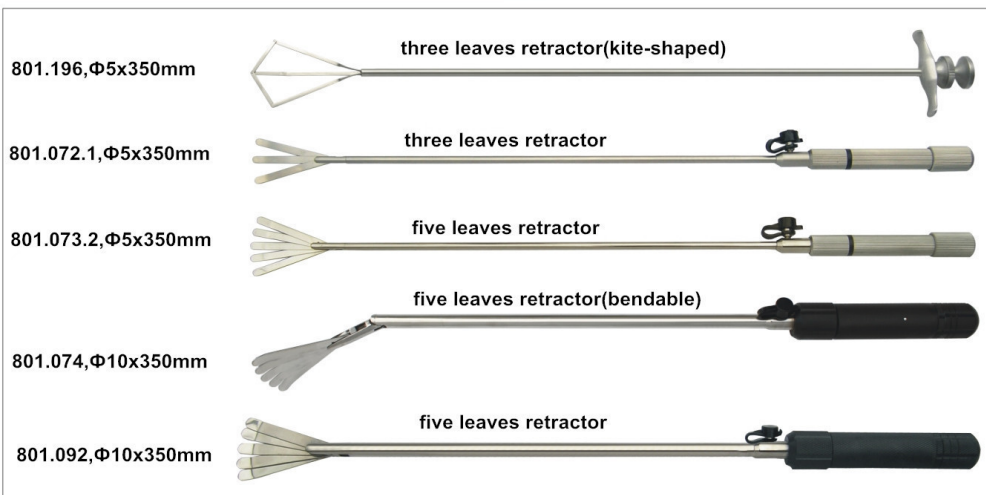



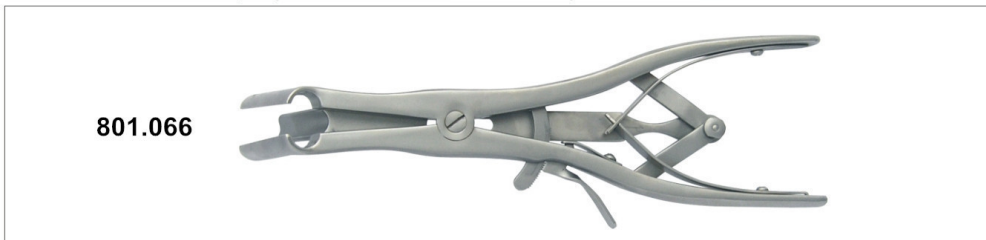

















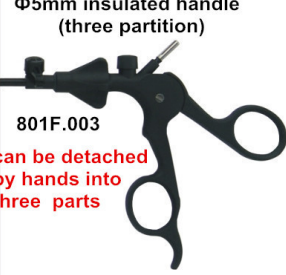





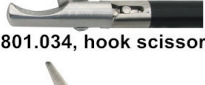

Distraction Forceps(three leaves retractor)

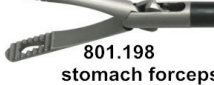
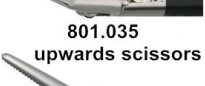

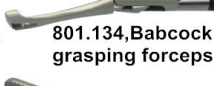
**Customize Length:
5mmx360mm/410mm/430mm/440mm/450mm/460mm**

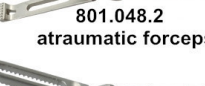
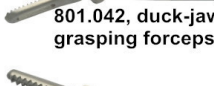
Laparoscopic Instruments

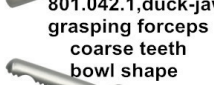
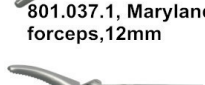
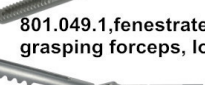
Forceps and Scissors, $\Phi 5$ X 330mm (common use, usually in stock)

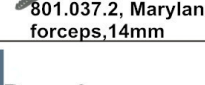
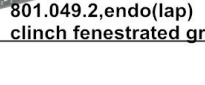
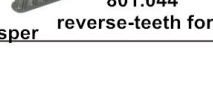
 801.032, straight scissors single action	 801.037.3, 18mm Maryland forceps	 801.045, organ-anchoring grasper	 $\Phi 5$ mm insulated handle (two partition) 801F.001 can be detached by hands into two parts
 801.032.1, straight scissors double action	 801.037.4, 20mm Maryland forceps	 801.047 cholecystic forceps	
 801.033, curved scissors single action	 801.037.5, 25mm Maryland forceps	 801.047.1, nine teeth cholecystic forceps	 $\Phi 5$ mm insulated handle (three partition) 801F.003 can be detached by hands into three parts
 801.033.1, curved scissors double action	 801.037.6, 16mm Maryland forceps blunt tip	 801.048 atraumatic forceps	
 801.033.2, micro-curved scissors, double action	 801.037.7, 45° Maryland forceps	 801.048.1 atraumatic forceps	 $\Phi 5$ mm stainless steel handle 801F.005 can not be detached by hands
 801.034, hook scissors	 801.038, Mixer right angle, 90°	 801.198 stomach forceps	
 801.035 upwards scissors	 801.052, appendix grasping forceps	 801.134, Babcock grasping forceps	 $\Phi 5$ mm stainless steel handle 801F.006 self-locking can not be detached by hands
 801.036 straight grasper	 801.048.2 atraumatic forceps	 801.042, duck-jaw grasping forceps	
 801.037, Maryland forceps, 17mm	 801.049, fenestrated grasping forceps	 801.042.1, duck-jaw grasping forceps coarse teeth bowl shape	
 801.037.1, Maryland forceps, 12mm	 801.049.1, fenestrated grasping forceps, long tip	 801.043 Maxi grasper	
 801.037.2, Maryland forceps, 14mm	 801.049.2, endo(lap) clinch fenestrated grasper	 801.044 reverse-teeth forceps	





Customize Length:

5mmx360mm/410mm/430mm/440mm/450mm/460mm

Laparoscopic Instruments



Forceps and Scissors, $\Phi 5\text{mm} \times 330\text{mm}$, common use, usually in stock

<p>801.044.1 reverse-teeth forceps</p> <p>801.050 bullet nose forceps</p> <p>801.051, dolphin nose grasper</p> <p>801.053, cupped biopsy forceps</p> <p>801.054, biopsy forceps, sharp cupped jaw</p> <p>801.105, claw forceps, 2+4 teeth, single action</p> <p>801.105.1, Cobra grasper 2+4 teeth, double action</p> <p>801.195.1, grasper 1+2 teeth, double action</p> <p>801.055, biting & cutting forceps</p> <p>801.057, fallopian tube grasping forceps</p> <p>801.057.1, Oviduct forceps</p> <p>801.058, mucous membrane forceps hollow</p> <p>801.058.2, mucous membrane forceps</p>	<p>801.059, hollow erect grasping forceps</p> <p>801.059.1, hollow erect grasping forceps, long tip</p> <p>801.044.2, grasper (reverse teeth)</p> <p>801.046.1, grasper 2+3 teeth, double action</p> <p>801.062, V-shaped grasping forceps</p> <p>801.060, Allis grasper</p> <p>801.062.1, V-shaped grasping forceps</p> <p>801.060.1, Allis grasper longer tip</p> <p>801.056, Debakey grasping forceps</p> <p>801.056.1, Debakey grasping forceps (hollow)</p> <p>801.056.3, bowel forceps</p> <p>801.056.4, intestinal grasping forceps</p>	<p>801.031 knot forceps</p> <p>801.031.1, B shape knot forceps</p> <p>801.030 knot forceps S shape</p> <p>801.198.1, stomach grasping forceps, curved</p> <p>801.061, O-shaped grasping forceps</p> <p>801.116, ureteral grasping forceps</p> <p>801.133, claw forceps</p> <p>801.072.2 sector forceps</p>	<p>$\Phi 5\text{mm}$ insulated handle (two partition), with ratchet</p> <p>801F.002</p> <p>can be detached by hands into two parts</p>  <p>$\Phi 5\text{mm}$ insulated handle (three partition), with ratchet</p> <p>801F.004</p> <p>can be detached by hands into three parts</p>  <p>$\Phi 5\text{mm}$ stainless steel handle (with upper ratchet)</p> <p>801F.008</p> <p>can not be detached by hands</p>  <p>$\Phi 5\text{mm}$ stainless steel handle (with down ratchet)</p> <p>801F.007</p> <p>can not be detached by hands</p> 
--	--	--	--

Customize Length:
5mmx360mm/410mm/430mm/440mm/450mm/460mm

Laparoscopic Instruments

Forceps and Scissors, Φ 10mmx330mm, common use, usually in stock

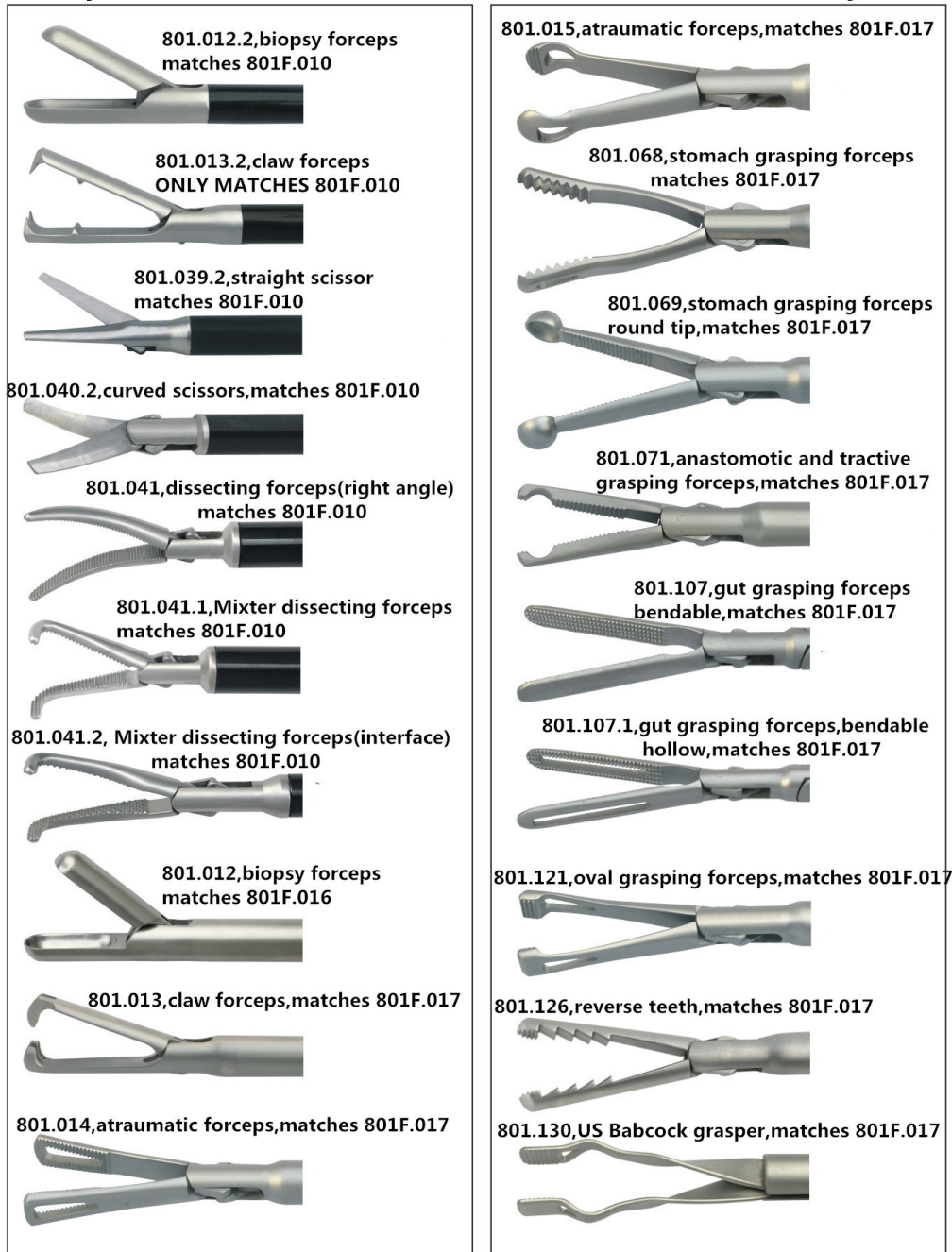













Note: the above match are the best choice and common use based on clinical condition.

**Customize Length:
10mmx360mm/410mm/430mm/440mm/450mm/460mm**

Laparoscopic Instruments

Forceps and Scissors, $\Phi 10\text{mm} \times 330\text{mm}$, common use and usually in stock

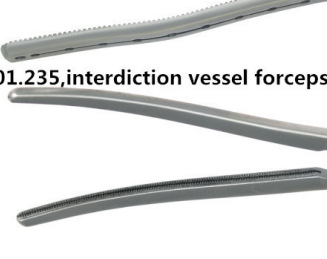
<p>801.135, grasping forceps(eight claws), matches 801F.017</p> 	 <p>801F.010 insulated handle (two partition)</p>
<p>802.002, lobe grasping forceps, matches 801F.017</p> 	 <p>801F.012 insulated handle (three partition)</p>
<p>802.003, (fixed grasping forceps, with rough teeth) matches 801F.017</p> 	 <p>801F.015 stainless steel handle, can not be detached by hands (self-locked)</p>
<p>802.004, (toothless grasping forceps (with wide mouth) matches 801F.017</p> 	 <p>801F.016 stainless steel handle, can not be detached by hands</p>
<p>802.007, (duck-jaw grasping forceps), matches 801F.017</p> 	 <p>801F.017 stainless steel handle, can not be detached by hands (with down ratchet)</p>
<p>802.005, grasping forceps (with long chin) matches 801F.017</p> 	
<p>801.070, suture grasping forceps, matches 801F.017</p> 	
<p>801.235, interdiction vessel forceps, matches 801F.017</p> 	

Note: the above match are best and common choice, more match let us discuss.

Customize Length:
10mmx360mm/410mm/430mm/440mm/450mm/460mm

Laparoscopic Instruments

Detachable Picture of Instruments

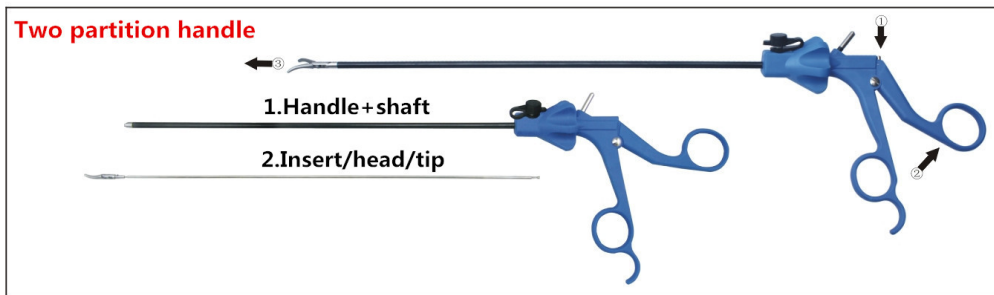
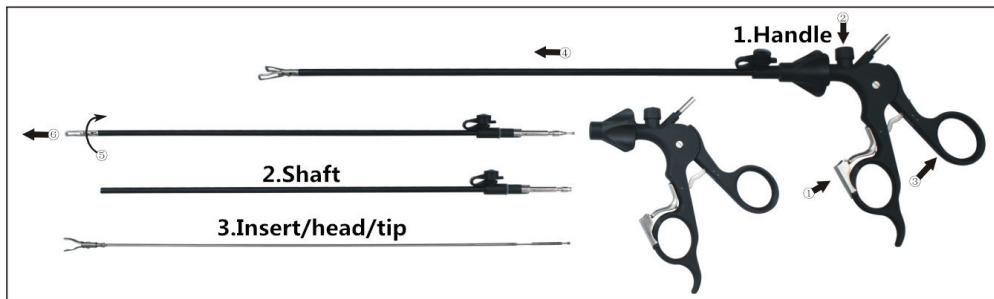
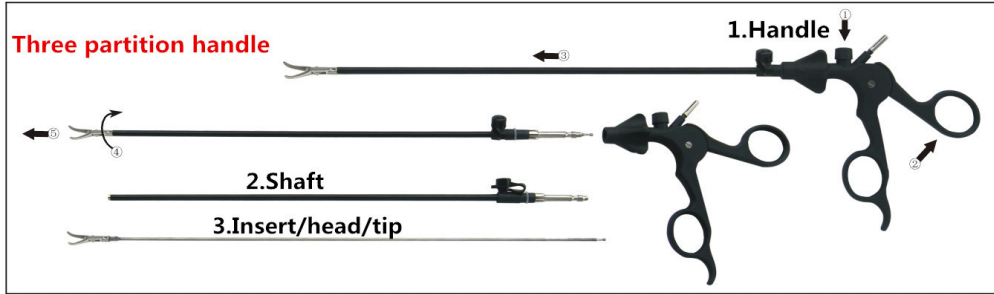

Golden Finger, $\Phi 5.5 \times 460 \text{mm}$

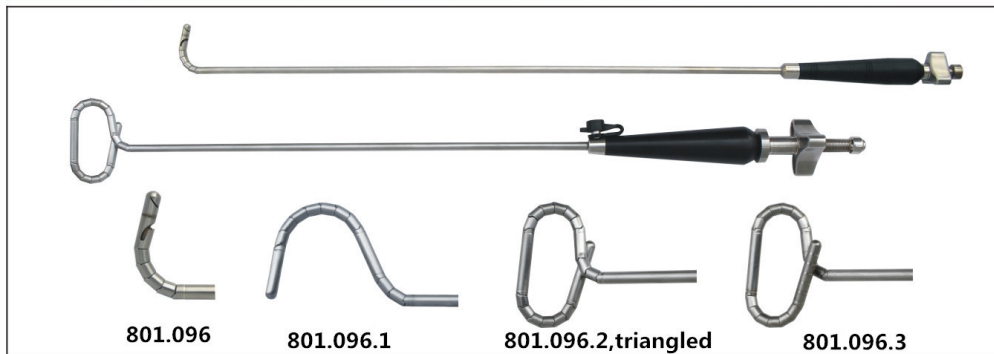

Laparoscopic Instruments

Liver Retractor & Renal Artery Retractor

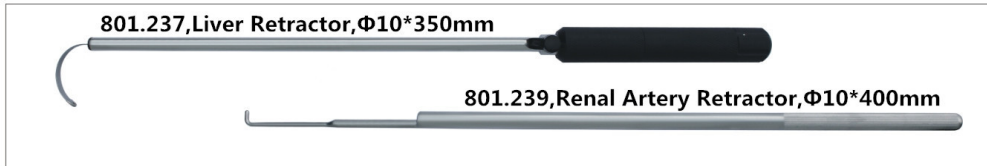

Biliary Tract-Lithotomy Forceps, $\Phi 5 \times 330$ mm



Cholangiography Forceps, $\Phi 5 \times 330$ mm

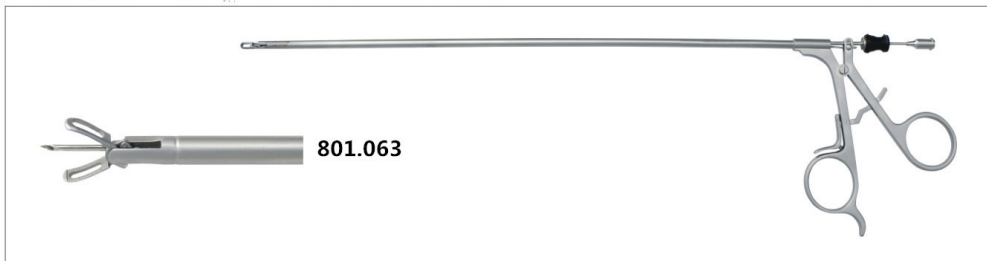

Vein/Nerve Retractor, $\Phi 10 \times 330$ mm

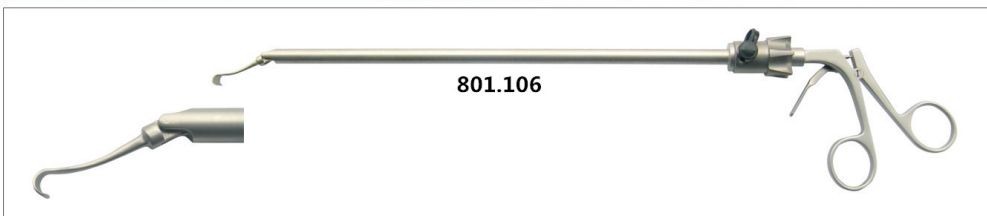

Spring Grasping Forceps, $\Phi 5 \times 330$ mm

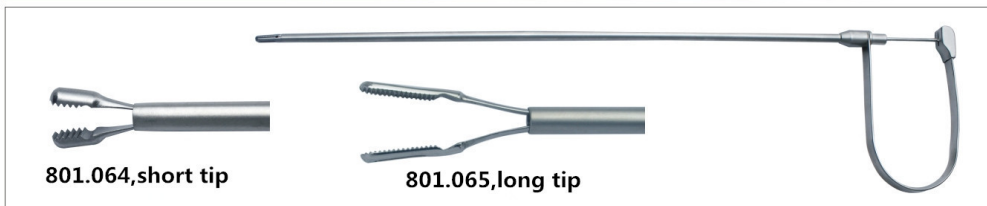

Laparoscopic Instruments

Esophagus Retractor, $\Phi 10 \times 330\text{mm}$

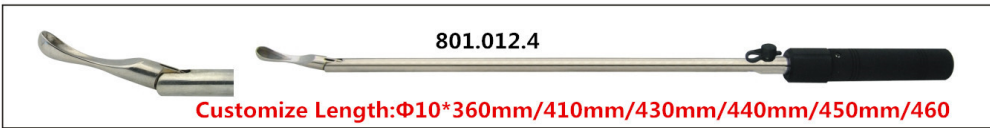

Thyroid Operating Instrument

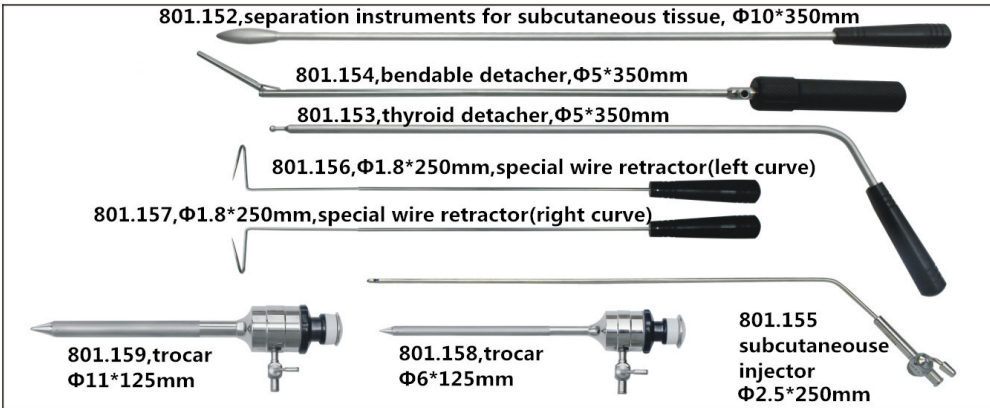

OC-806, Suspension Lift

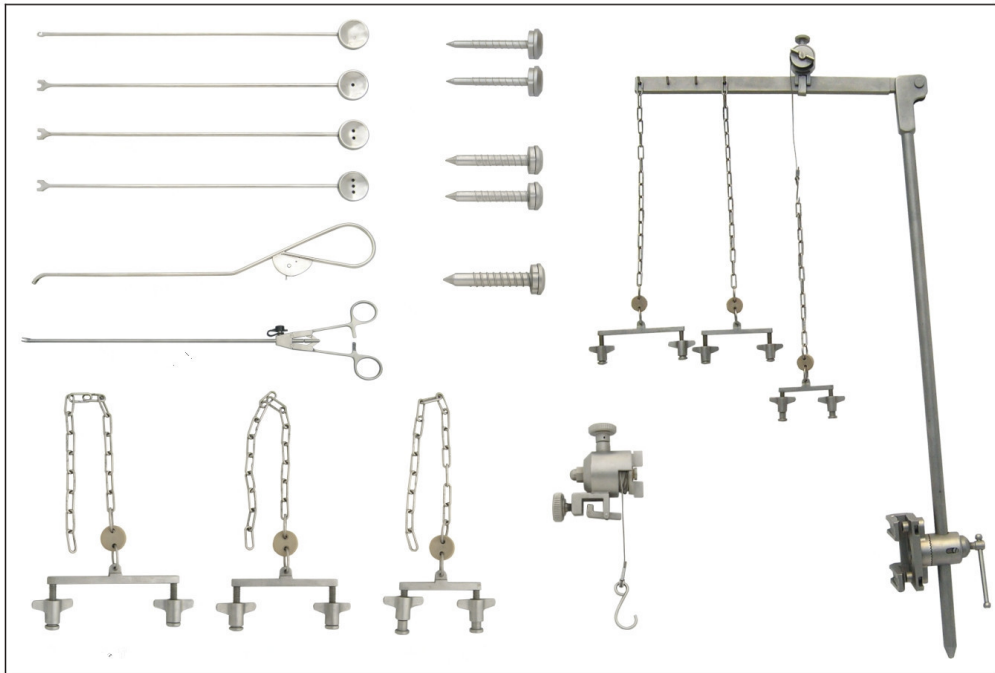

Laparoscopic Instruments

OC-802 Colon and Rectum Instruments, Φ10*330mm

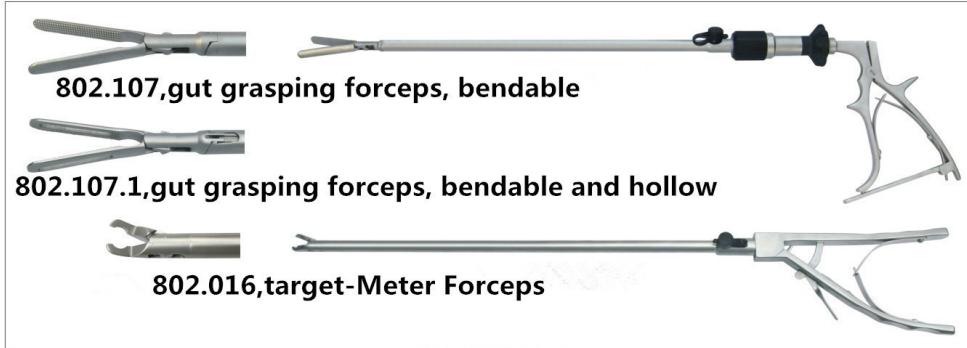

Miniature Instruments, for children and paediatric surgery

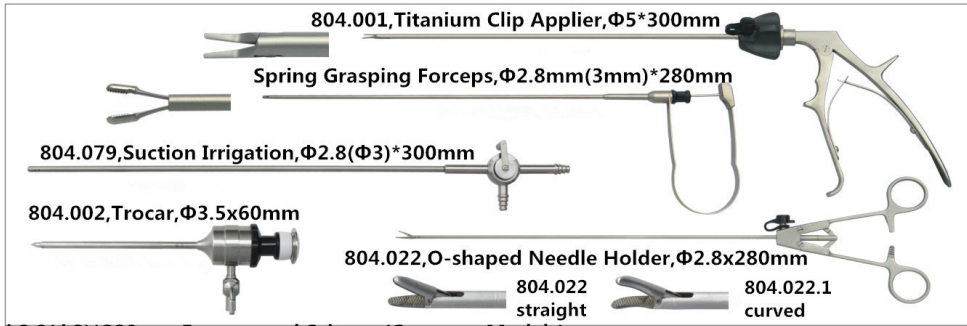

Φ2.8(Φ3)*280mm Forceps and Scissors(Common Models)

Customize Length: Φ2.8(Φ3)*300/330mm Forceps and Scissors

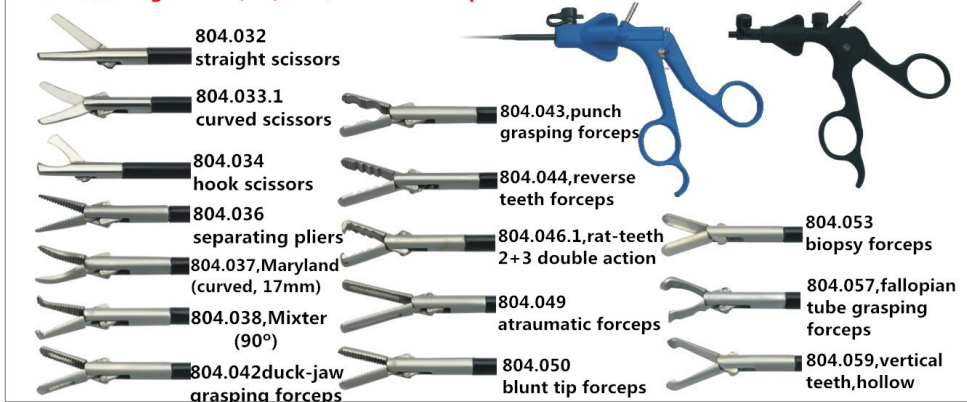

Customized Length: Φ2.8(Φ3)x300mm/330mm

Laparoscopic Instruments

OC-803 Instrument For SILS/Single Port Instruments

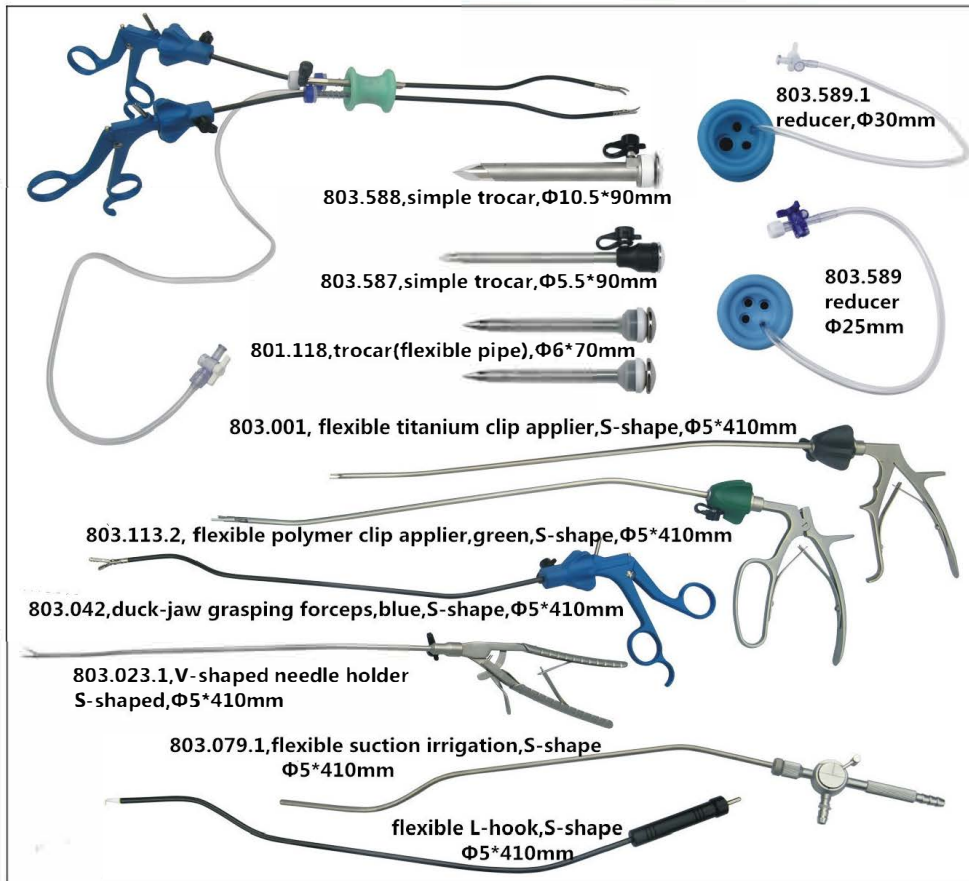

S-shape, $\Phi 5 \times 410\text{mm}$ Flexible Instruments

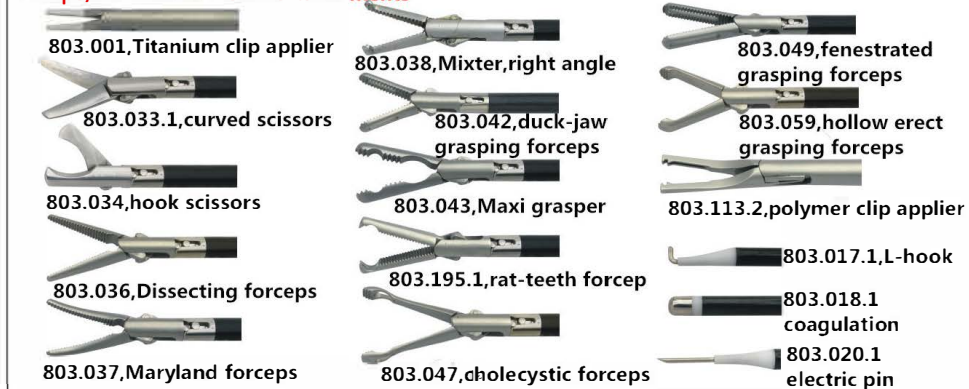

Gynecologic Surgical Instruments

OC-809, Flexible Instruments, $\Phi 5 \times 410\text{mm}$

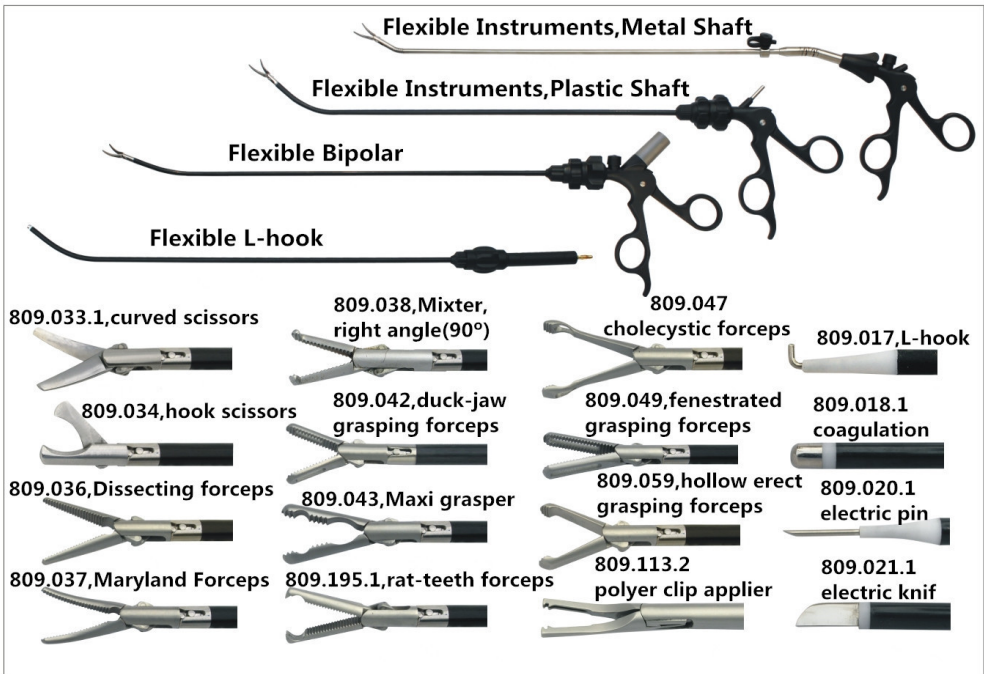

Uterine Manipulator

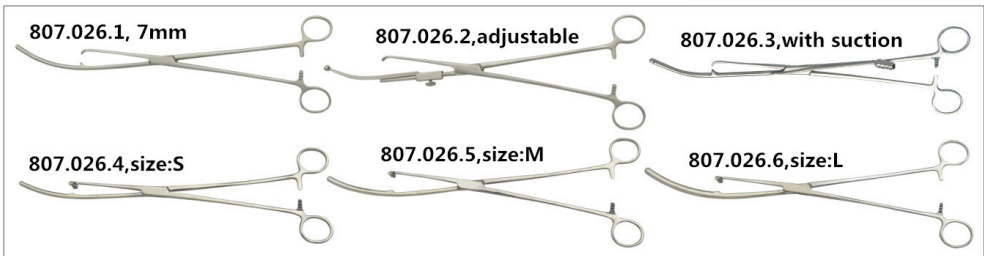

Uterine Manipulator

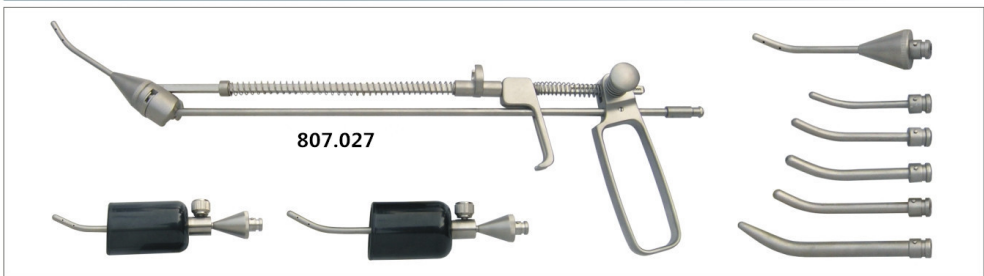

Gynaecology Surgical Instruments

Cup Type Uterine Manipulator

807.027.2

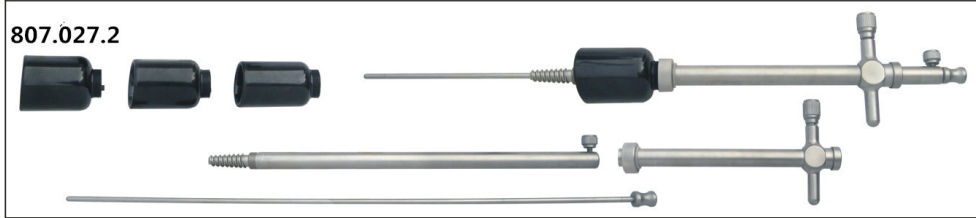

807.027.3

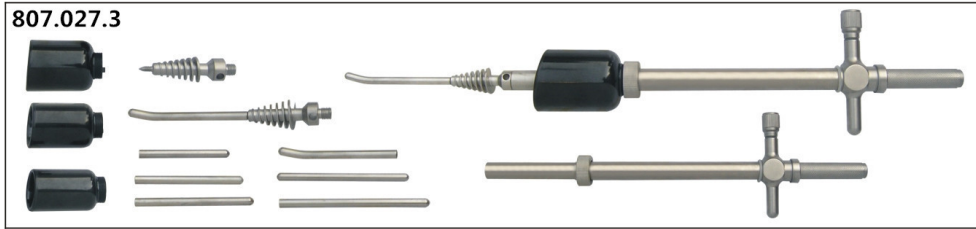

807.027.4

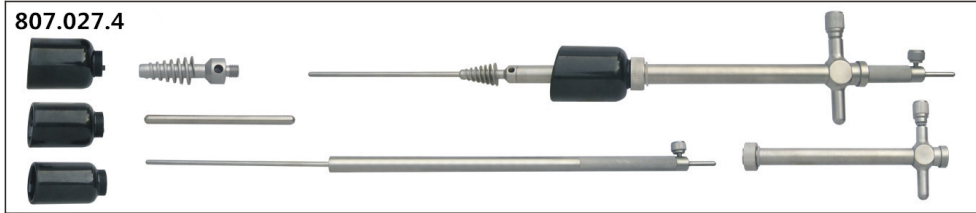

807.027.5

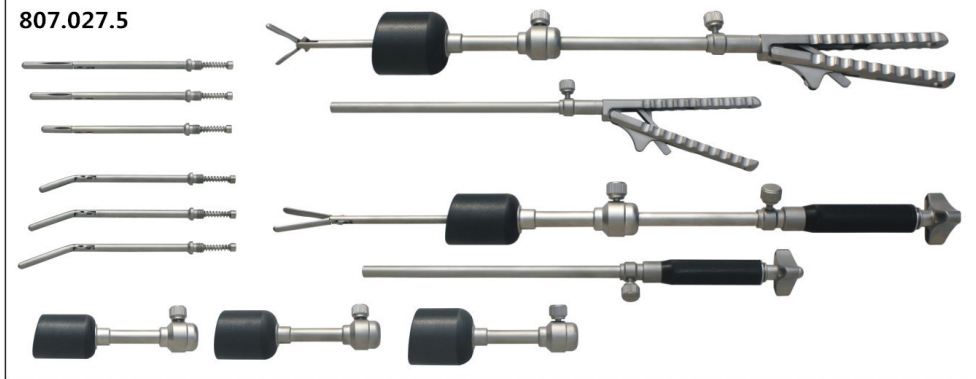

807.027.6



Gynaecology Surgical Instruments

Small Rod,Big Rod,Seprator

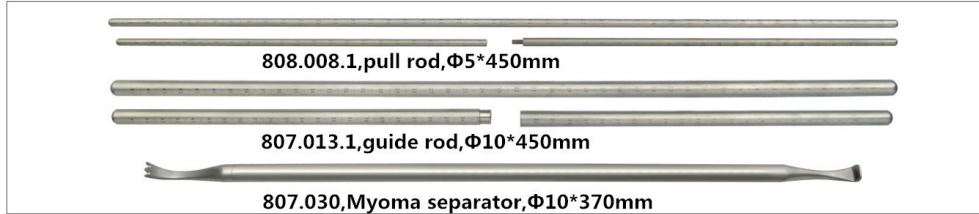

OC-810 Vaginal Instruments

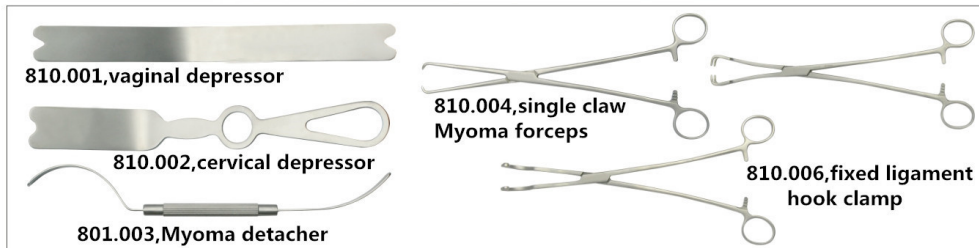

Gynaecology Surgical Instruments Kit,Light Cable:4mm/5mm*2000mm/2500mm/3000mm

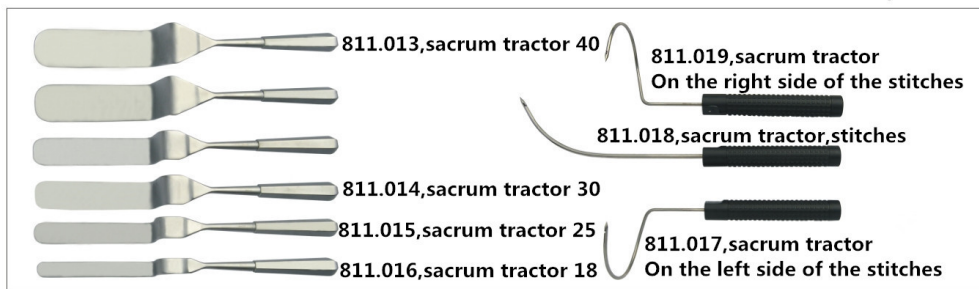
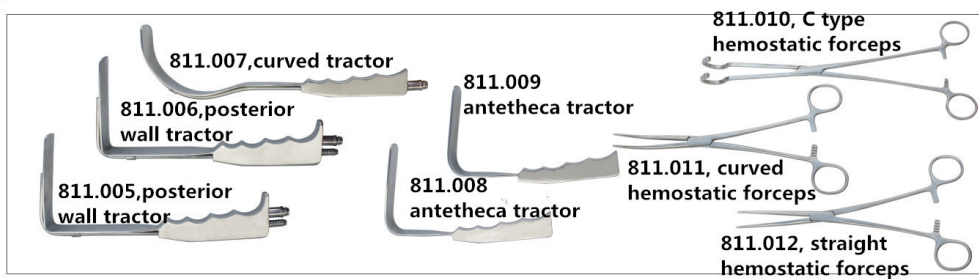
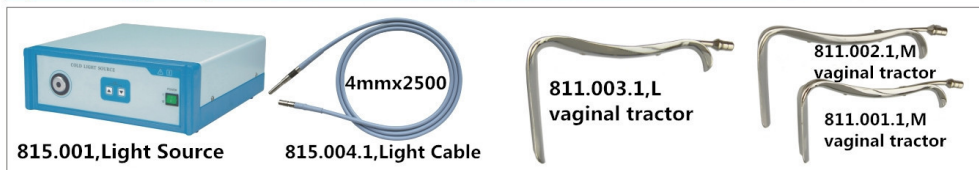

Gynaecology Surgical Instruments-Morcellator Whole Set

OC-807, Morcellator

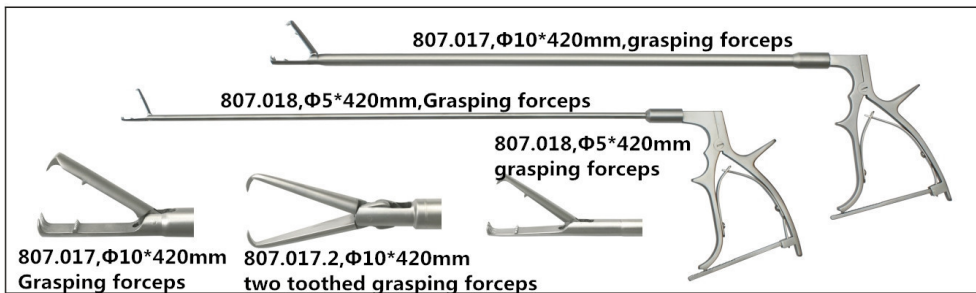
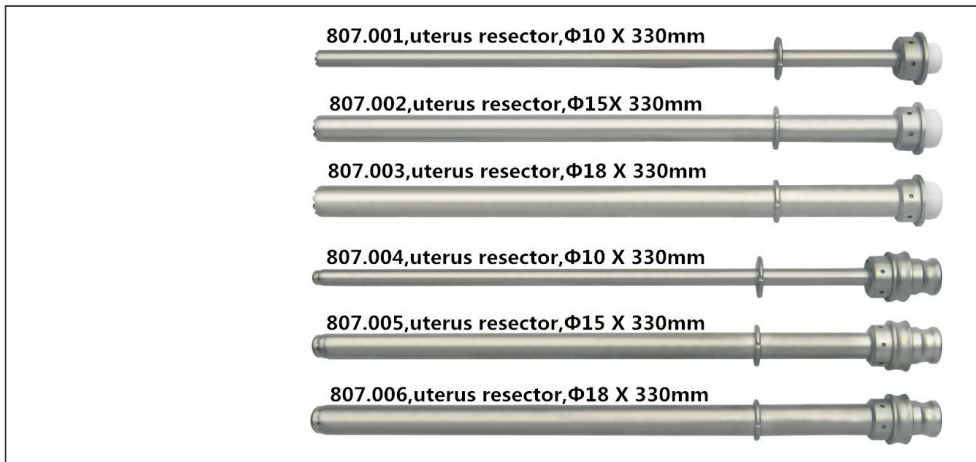

Gynaecology Surgical Instruments - Morcellator Whole Set

OC-807 Morcellator, whole set

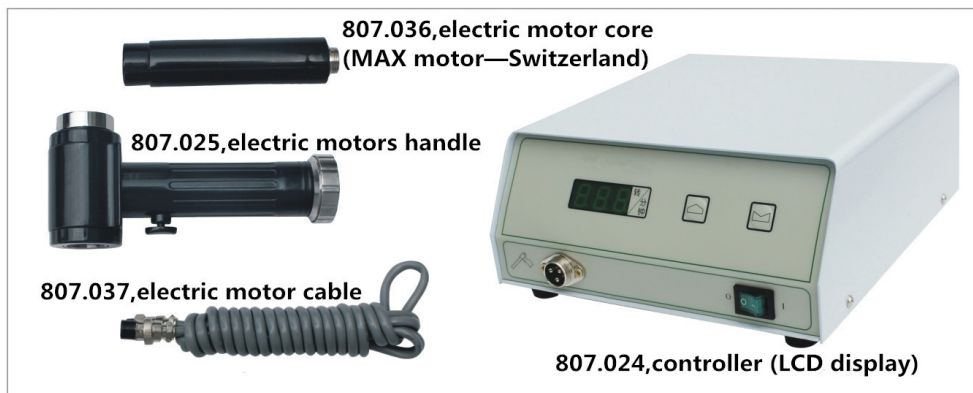
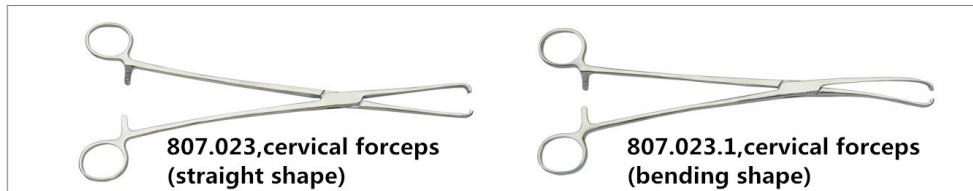
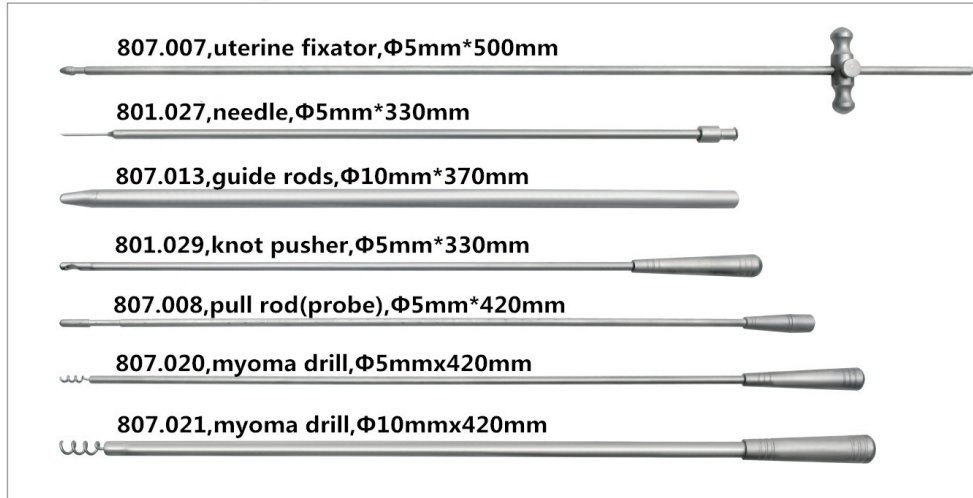

Disposable Instruments and Reusable Sterilization Case



805.550, Disposable Retrieval Bag



Disposable Endobag, 805.555, 200ML, 400ML, 800ML

Sterilization Case/Box

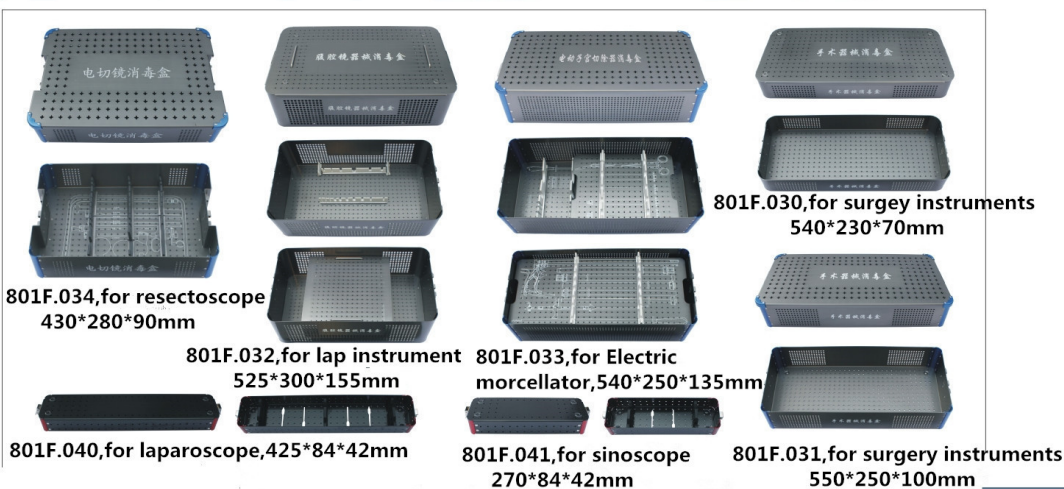



Endoscopic Equipments

