

**Skalpellklingen, Skalpellgriffe, Messer
Scalpel Blades, Scalpel Handles, Knives
Hojas de bisturíes, Mangos de bisturíes, Cuchillos
Lame per bisturi, Manici per bisturi, Coltelli**



Sterile Skalpelling, Skalpellinggriffe
Sterile Scalpel Blades, Scalpel Handles
Hojas de bisturíes estériles, Mangos de bisturíes
Lame per bisturi sterili, Manici per bisturi



No. 3
13,0 cm, 5"
10-4003-00



No. 3
13,0 cm, 5"
10-4003-01



No. 3L
21,0 cm, 8 1/4"
10-4003-02



No. 7
16,5 cm, 6 1/2"
10-4007-00

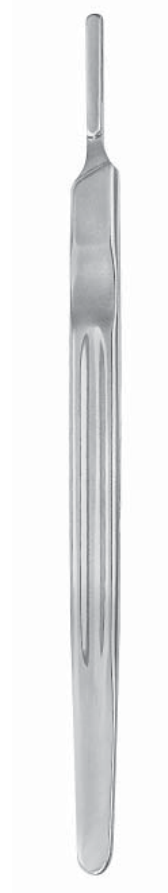

No. 7K
13,0 cm, 5"
10-4007-01

Sterile Skalpellklingen, Skalpellgriffe
Sterile Scalpel Blades, Scalpel Handles
Hojas de bisturíes estériles, Mangos de bisturíes
Lame per bisturi sterili, Manici per bisturi



No. 4
13,5 cm, 5³/₈"
10-4004-00



No. 4L
21,0 cm, 8³/₈"
10-4004-01



No. 8
13,5 cm, 5³/₈"
10-4008-00



No. 9
14,5 cm, 5³/₄"
10-4009-00

Einmal-Skalpelle, steril
Disposable Scalpels, sterile
Bisturíes para uso único, estériles
Bisturi monouso, sterili



Fig. 10
10-4050-10



Fig. 11
10-4050-11



Fig. 11s
10-4050-11S



Fig. 12
10-4050-12



Fig. 12d
10-4050-12D



Fig. 13
10-4050-13



Fig. 15
10-4050-15



Fig. 15c
10-4050-15C

Einmal-Skalpelle, steril
Disposable Scalpels, sterile
Bisturíes para uso único, estériles
Bisturi monouso, sterili



Fig. 18
10-4050-18



Fig. 19
10-4050-19



Fig. 20
10-4050-20



Fig. 21
10-4050-21

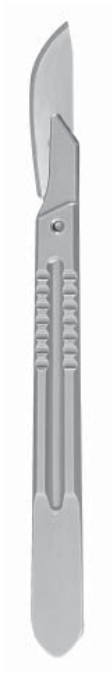

Fig. 22
10-4050-22



Fig. 23
10-4050-23



Fig. 24
10-4050-24

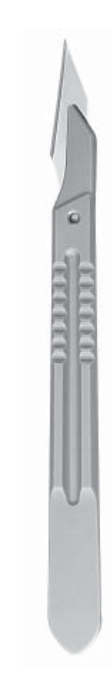

Fig. 25
10-4050-25

Skalpelle
Knives
Bisturies
Bisturi



OPERATION
17,0 cm, 6¾"

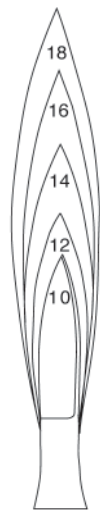

Fig. 10 **10-4060-10**
Fig. 12 **10-4060-12**
Fig. 14 **10-4060-14**
Fig. 16 **10-4060-16**
Fig. 18 **10-4060-18**



COLLIN
16,0 cm, 6¼"



Fig. 1 **10-4066-01**
Fig. 2 **10-4066-02**
Fig. 3 **10-4066-03**



Fig. 4 **10-4066-04**
Fig. 5 **10-4066-05**
Fig. 6 **10-4066-06**



Fig. 1 **10-4070-01**
Fig. 2 **10-4070-02**
Fig. 3 **10-4070-03**
Fig. 4 **10-4070-04**
Fig. 5 **10-4070-05**



Fig. 1 **10-4076-01**
Fig. 2 **10-4076-02**
Fig. 3 **10-4076-03**
Fig. 4 **10-4076-04**
Fig. 5 **10-4076-05**



Fig. 15 **10-4078-15**



Fig. 6 **10-4070-06**
Fig. 7 **10-4070-07**
Fig. 8 **10-4070-08**
Fig. 9 **10-4070-09**
Fig. 10 **10-4070-10**



Fig. 6 **10-4076-06**
Fig. 7 **10-4076-07**
Fig. 8 **10-4076-08**
Fig. 9 **10-4076-09**

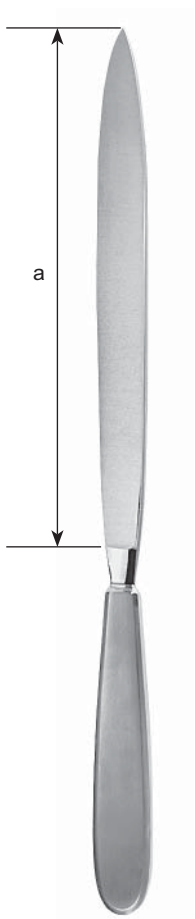

Fig. 16 **10-4078-16**

DISSECTING
17,0 cm, 6¾"

DIEFENBACH
16,0 cm, 6¼"

Amputationsmesser
 Amputation Knives
 Cuchillos para amputación
 Coltelli per amputazione



COLLIN

a	
13,0 cm, 5"	10-4080-13
16,0 cm, 6 ¹ / ₄ "	10-4080-16
19,0 cm, 7 ¹ / ₂ "	10-4080-19
22,0 cm, 8 ⁵ / ₈ "	10-4080-22
28,0 cm, 11"	10-4080-28

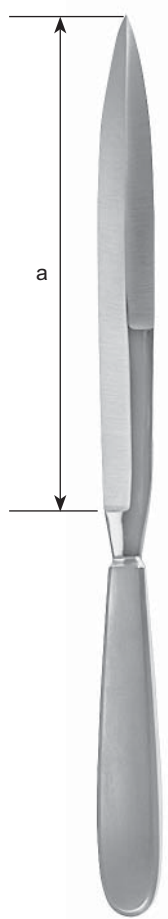

CATLIN

A	
16,0 cm, 6 ¹ / ₄ "	10-4082-16
19,0 cm, 7 ¹ / ₂ "	10-4082-19
22,0 cm, 8 ⁵ / ₈ "	10-4082-22

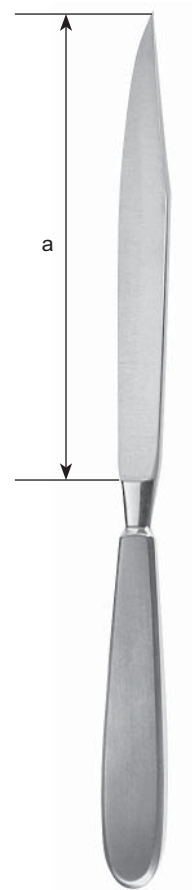

LISTON

A	
17,0 cm, 6 ³ / ₄ "	10-4250-17
20,0 cm, 8"	10-4250-20
22,0 cm, 8 ⁵ / ₈ "	10-4250-22

Amputationsmesser, Messer für Autopsie
 Amputation Knives, Post Mortem Knives
 Cuchillos para amputación, Cuchillos para autopsia
 Coltelli per amputazione, Coltelli per autopsia

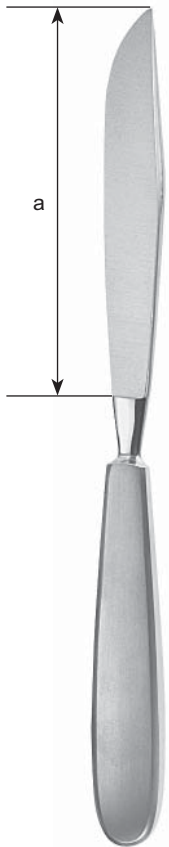

LANGENBECK
 10-4280-12

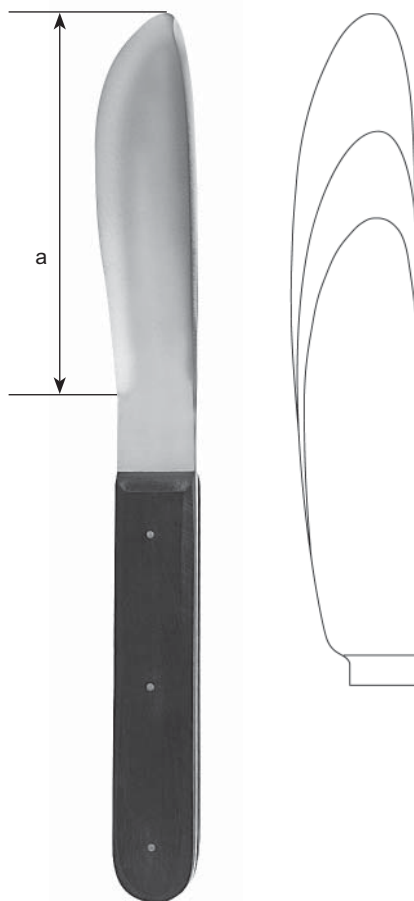

WALB

A	
11,0 cm, 4 1/2"	10-4150-11
14,0 cm, 5 1/2"	10-4150-14
17,0 cm, 6 3/4"	10-4150-17

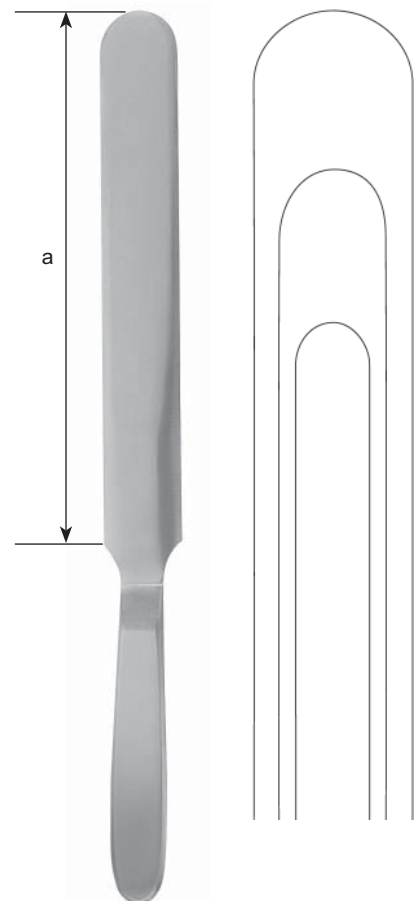

VIRCHOW

A	
16,0 cm, 6 1/4"	10-4180-16
20,0 cm, 8"	10-4180-20
24,0 cm, 9 1/2"	10-4180-24

Amputationsmesser, Dermatomye
Amputation Knives, Dermatomyes
Cuchillos para amputación, Dermátomos
Coltelli per amputazione, Dermatomyi



LANGENBECK
18,0 cm, 7"
10-4105-55



mit Schaber
with raspatory
con periostótomo
con raschiatoio

CARTILAGE
17,5 cm, 6⁵/₈"
10-4110-65

Haut-Spannplatten
Skin straightening plate
Placa para extender la piel
Placca per stendere la pelle

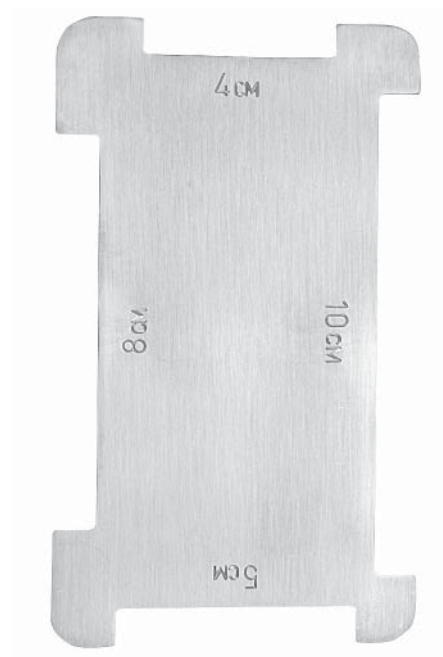

10-4422-30

**Resektionsmesser
Resection Knives
Cuchillos para resección
Coltelli per resezione**

10-4401-19
Ersatzklinge
Spare blade
Hoja de repuesto
Lama di ricambio



SILVER
19 cm, 7 1/2"
10-4400-19

10-4411-30
Ersatzklinge
Spare blade
Hoja de repuesto
Lama di ricambio



BRAITHWAITE
30,0 cm, 12"
10-4410-30

10-4413-35
Ersatzklinge
Spare blade
Hoja de repuesto
Lama di ricambio



HUMBY
35,0 cm, 14"
10-4412-35

10-4421-30
Ersatzklinge
Spare blade
Hoja de repuesto
Lama di ricambio



SCHINK
30,0 cm, 12"
10-4420-30

Scheren
Scissors
Tijeras
Forbici



Chirurgische Scheren
 Surgical Scissors
 Tijeras para cirugía
 Forbici per chirurgia



STANDARD	
10,5 cm, 4 ¹ / ₄ "	11-4000-10
11,5 cm, 4 ¹ / ₂ "	11-4000-11
13,0 cm, 5"	11-4000-13
14,5 cm, 5 ³ / ₄ "	11-4000-14
15,5 cm, 6"	11-4000-15
16,5 cm, 6 ¹ / ₂ "	11-4000-16
17,5 cm, 6 ⁵ / ₈ "	11-4000-17
18,5 cm, 7 ¹ / ₄ "	11-4000-18
20,0 cm, 8"	11-4000-20

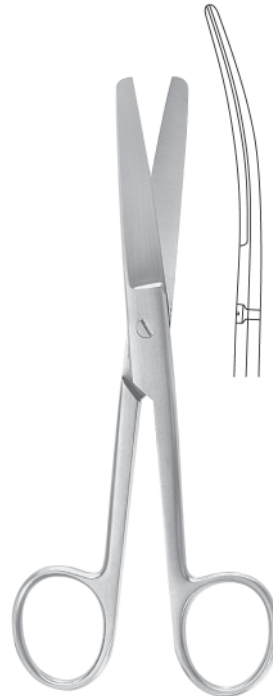

STANDARD	
10,5 cm, 4 ¹ / ₄ "	11-4001-10
11,5 cm, 4 ¹ / ₂ "	11-4001-11
13,0 cm, 5"	11-4001-13
14,5 cm, 5 ³ / ₄ "	11-4001-14
15,5 cm, 6"	11-4001-15
16,5 cm, 6 ¹ / ₂ "	11-4001-16
17,5 cm, 6 ⁵ / ₈ "	11-4001-17
18,5 cm, 7 ¹ / ₄ "	11-4001-18
20,0 cm, 8"	11-4001-20



STANDARD	
10,5 cm, 4 ¹ / ₄ "	11-4002-10
11,5 cm, 4 ¹ / ₂ "	11-4002-11
13,0 cm, 5"	11-4002-13
14,5 cm, 5 ³ / ₄ "	11-4002-14
15,5 cm, 6"	11-4002-15
16,5 cm, 6 ¹ / ₂ "	11-4002-16
17,5 cm, 6 ⁵ / ₈ "	11-4002-17
18,5 cm, 7 ¹ / ₄ "	11-4002-18
20,0 cm, 8"	11-4002-20

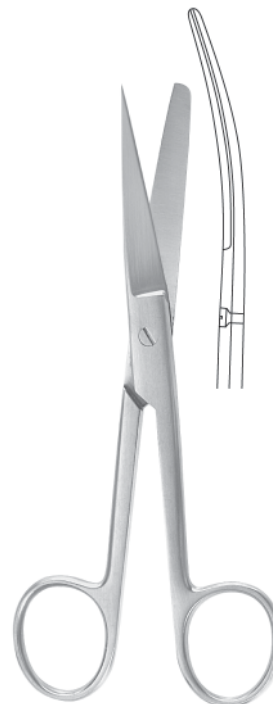

STANDARD	
10,5 cm, 4 ¹ / ₄ "	11-4003-10
11,5 cm, 4 ¹ / ₂ "	11-4003-11
13,0 cm, 5"	11-4003-13
14,5 cm, 5 ³ / ₄ "	11-4003-14
15,5 cm, 6"	11-4003-15
16,5 cm, 6 ¹ / ₂ "	11-4003-16
17,5 cm, 6 ⁵ / ₈ "	11-4003-17
18,5 cm, 7 ¹ / ₄ "	11-4003-18
20,0 cm, 8"	11-4003-20

Chirurgische Scheren, Präparierscheren
 Surgical Scissors, Dissecting Scissors
 Tijeras para cirugía, Tijeras de disección
 Forbici per chirurgia, Forbici per dissezione

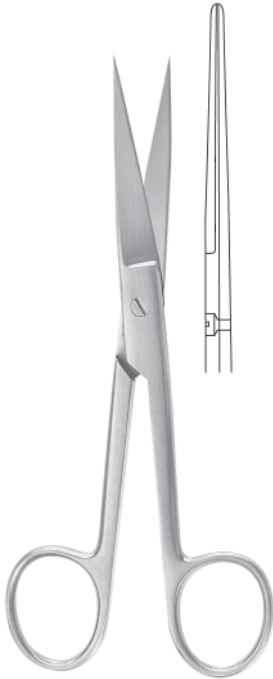

STANDARD	
10,5 cm, 4 ¹ / ₄ "	11-4004-10
11,5 cm, 4 ¹ / ₂ "	11-4004-11
13,0 cm, 5"	11-4004-13
14,5 cm, 5 ³ / ₄ "	11-4004-14
15,5 cm, 6"	11-4004-15
16,5 cm, 6 ¹ / ₂ "	11-4004-16
17,5 cm, 6 ⁵ / ₈ "	11-4004-17
18,5 cm, 7 ¹ / ₄ "	11-4004-18
20,0 cm, 8"	11-4004-20

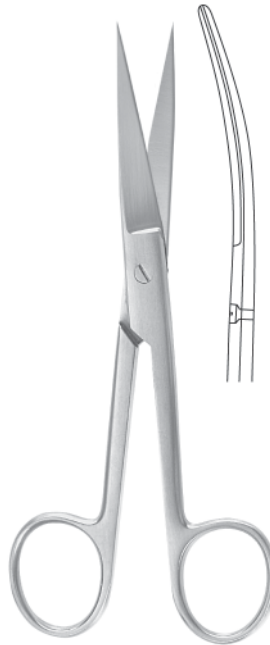

STANDARD	
10,5 cm, 4 ¹ / ₄ "	11-4005-10
11,5 cm, 4 ¹ / ₂ "	11-4005-11
13,0 cm, 5"	11-4005-13
14,5 cm, 5 ³ / ₄ "	11-4005-14
15,5 cm, 6"	11-4005-15
16,5 cm, 6 ¹ / ₂ "	11-4005-16
17,5 cm, 6 ⁵ / ₈ "	11-4005-17
18,5 cm, 7 ¹ / ₄ "	11-4005-18
20,0 cm, 8"	11-4005-20

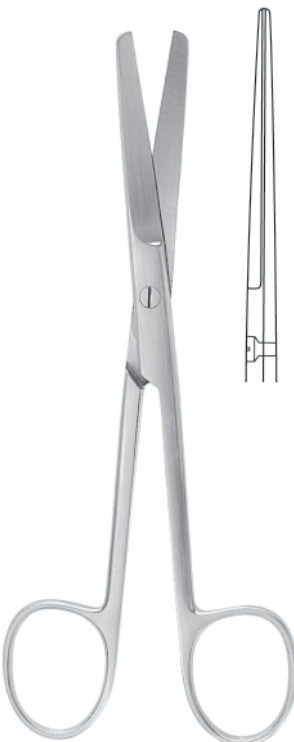

DEAVER	
12,0 cm, 4 ³ / ₄ "	11-4050-12
13,0 cm, 5"	11-4050-13
14,5 cm, 5 ³ / ₄ "	11-4050-14



DEAVER	
12,0 cm, 4 ³ / ₄ "	11-4051-12
13,0 cm, 5"	11-4051-13
14,5 cm, 5 ³ / ₄ "	11-4051-14

Präparierscheren
Dissecting Scissors
Tijeras de disección
Forbici per dissezione



DEAVER
 12,0 cm, 4³/₄" **11-4052-12**
 13,0 cm, 5" **11-4052-13**
 14,5 cm, 5³/₄" **11-4052-14**

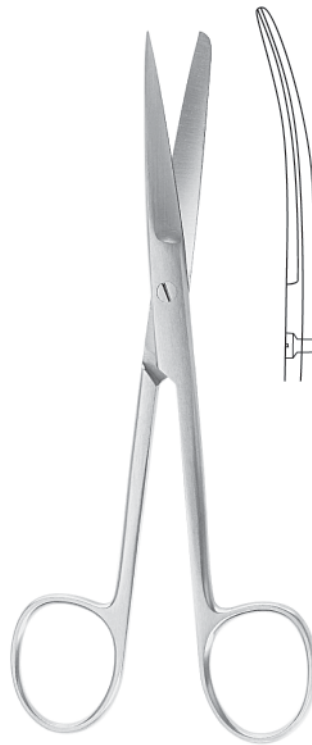

DEAVER
 12,0 cm, 4³/₄" **11-4053-12**
 13,0 cm, 5" **11-4053-13**
 14,5 cm, 5³/₄" **11-4053-14**



DEAVER
 12,0 cm, 4³/₄" **11-4054-12**
 13,0 cm, 5" **11-4054-13**
 14,5 cm, 5³/₄" **11-4054-14**

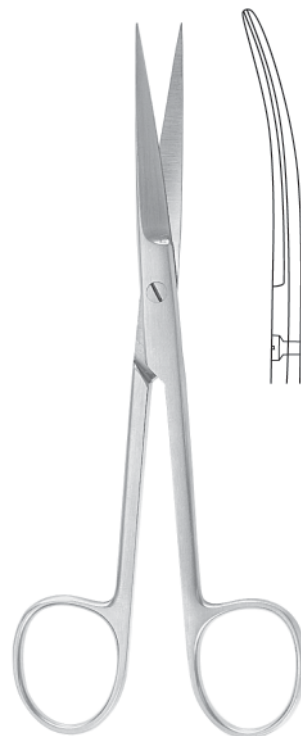

DEAVER
 12,0 cm, 4³/₄" **11-4055-12**
 13,0 cm, 5" **11-4055-13**
 14,5 cm, 5³/₄" **11-4055-14**

Präparierscheren
Dissecting Scissors
Tijeras de disección
Forbici per dissezione



GRAZIL
 13,0 cm, 5" **11-4070-13**
 14,5 cm, 5³/₄" **11-4070-14**



GRAZIL
 13,0 cm, 5" **11-4071-13**
 14,5 cm, 5³/₄" **11-4071-14**



GRAZIL
 13,0 cm, 5" **11-4072-13**
 14,5 cm, 5³/₄" **11-4072-14**



GRAZIL
 13,0 cm, 5" **11-4073-13**
 14,5 cm, 5³/₄" **11-4073-14**

Präparierscheren
Dissecting Scissors
Tijeras de disección
Forbici per dissezione



GRAZIL

13,0 cm, 5"	11-4074-13
14,5 cm, 5 ³ / ₄ "	11-4074-14



GRAZIL

13,0 cm, 5"	11-4075-13
14,5 cm, 5 ³ / ₄ "	11-4075-14

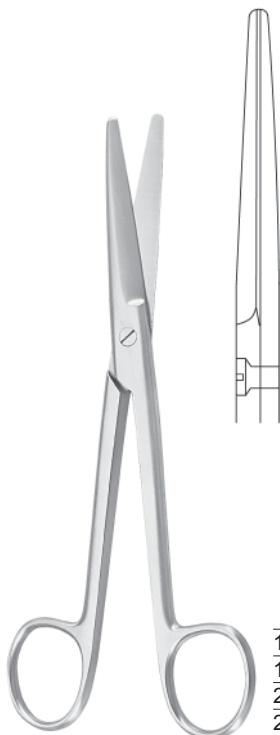

MAYO

14,5 cm, 5 ³ / ₄ "	11-4100-14
17,0 cm, 6 ³ / ₄ "	11-4100-17
23,0 cm, 9"	11-4100-23
28,0 cm, 11"	11-4100-28

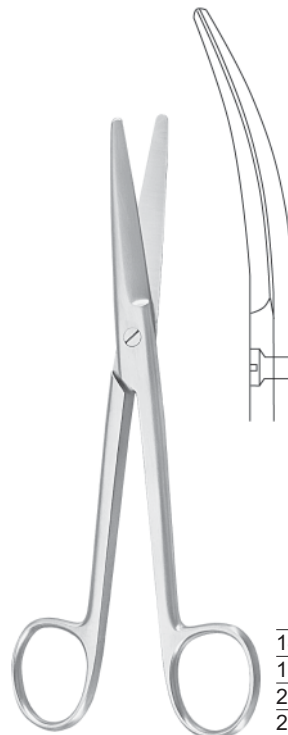

MAYO

14,5 cm, 5 ³ / ₄ "	11-4101-14
17,0 cm, 6 ³ / ₄ "	11-4101-17
23,0 cm, 9"	11-4101-23
28,0 cm, 11"	11-4101-28



MAYO-STILE
 15,0 cm, 6" 11-4102-15
 17,0 cm, 6³/₄" 11-4102-17
 19,5 cm, 7³/₄" 11-4102-19
 21,0 cm, 8¹/₄" 11-4102-21

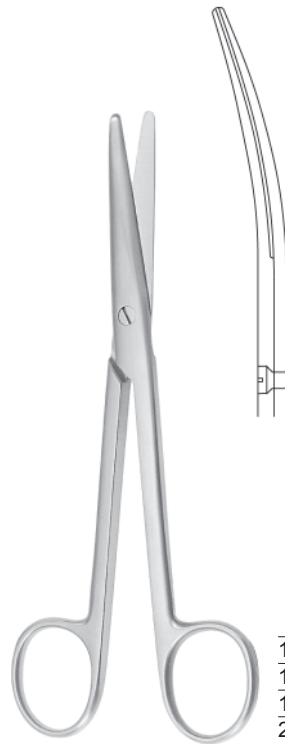

MAYO-STILE
 15,0 cm, 6" 11-4103-15
 17,0 cm, 6³/₄" 11-4103-17
 19,5 cm, 7³/₄" 11-4103-19
 21,0 cm, 8¹/₄" 11-4103-21



MAYO-NOBLE
 17,0 cm, 6³/₄"

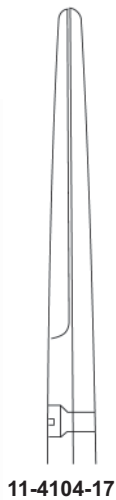

11-4104-17

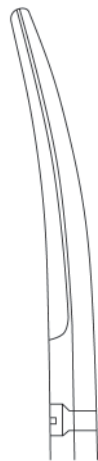

11-4105-17



FOMON
 13,5 cm, 5³/₈" 11-4009-13

Präparierscheren
Dissecting Scissors
Tijeras de disección
Forbici per dissezione



BABY-METZENBAUM
 11,5 cm, 4½"



11-4110-11



11-4111-11



METZENBAUM
 14,5 cm, 5¾"



11-4110-14

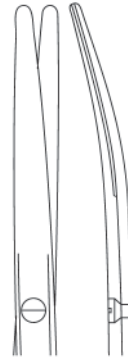

11-4111-14



METZENBAUM
 14,5 cm, 5¾"



11-4113-14



METZENBAUM
 14,5 cm, 5¾"



11-4115-14

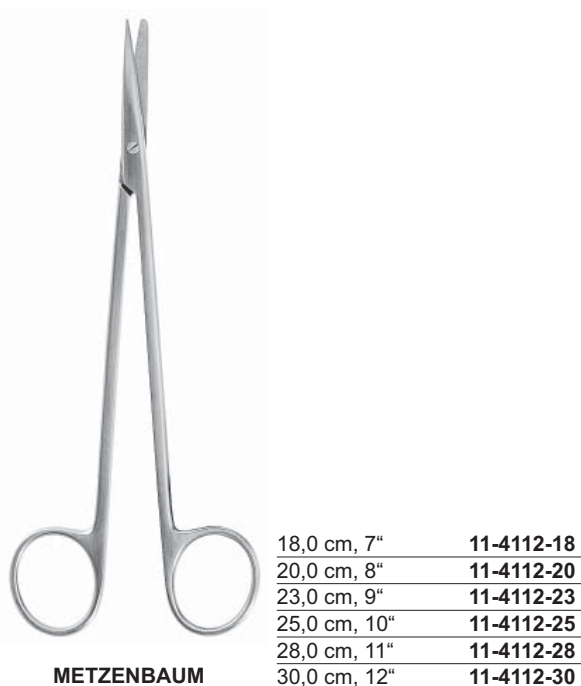
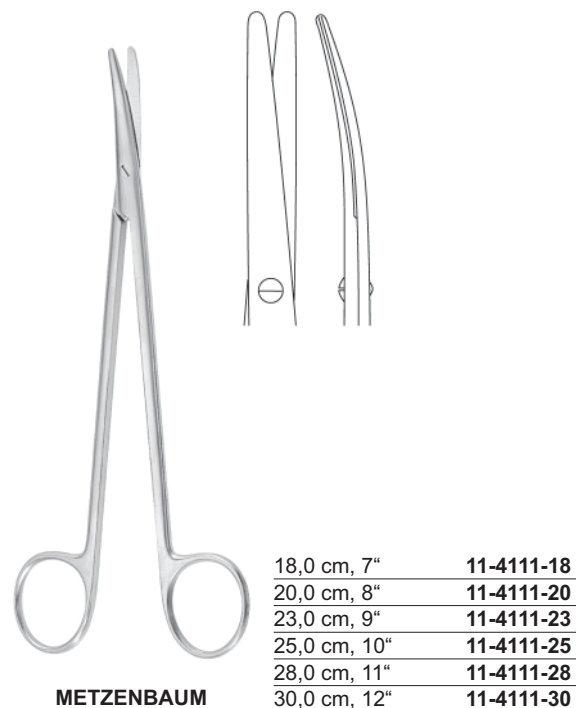
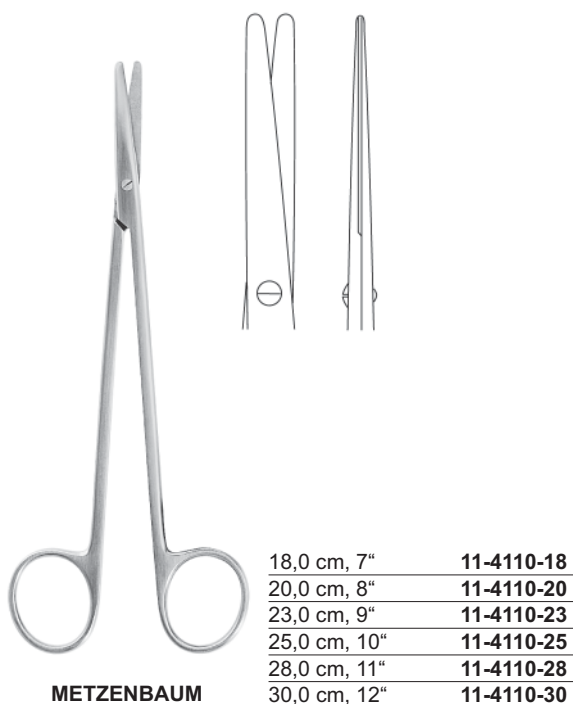

Präparierscheren
Dissecting Scissors
Tijeras de disección
Forbici per dissezione

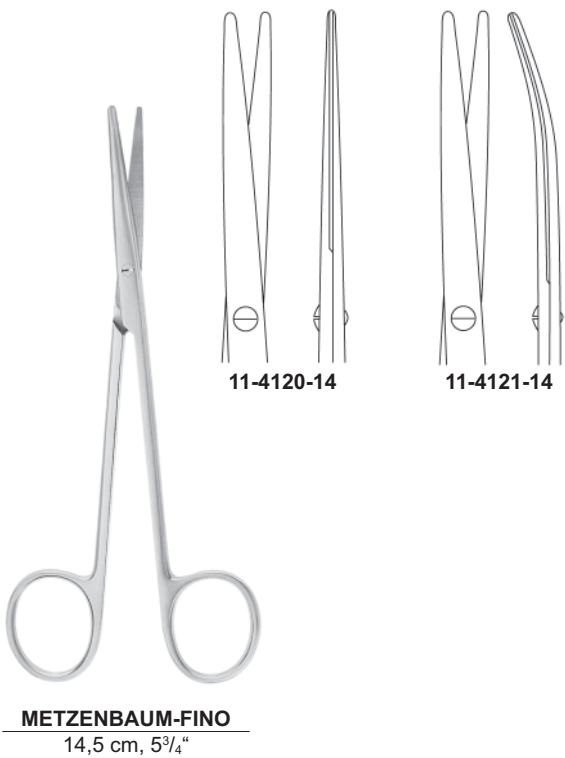
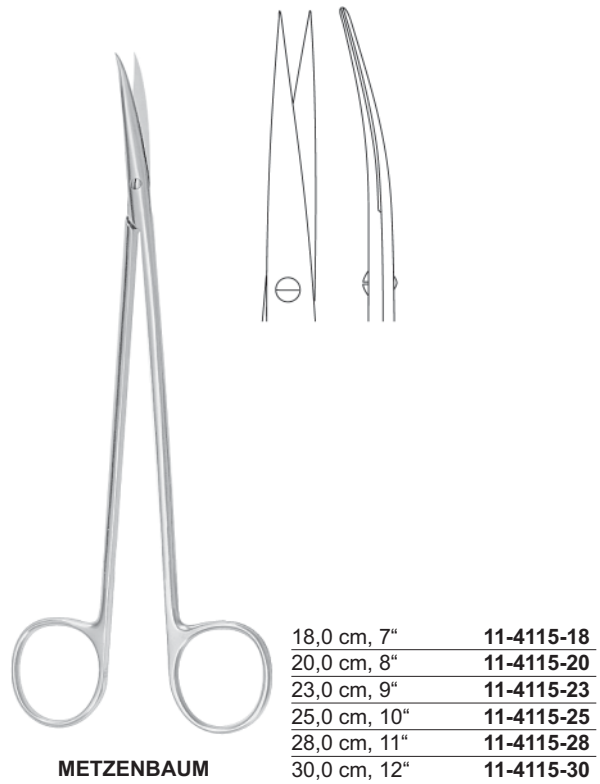
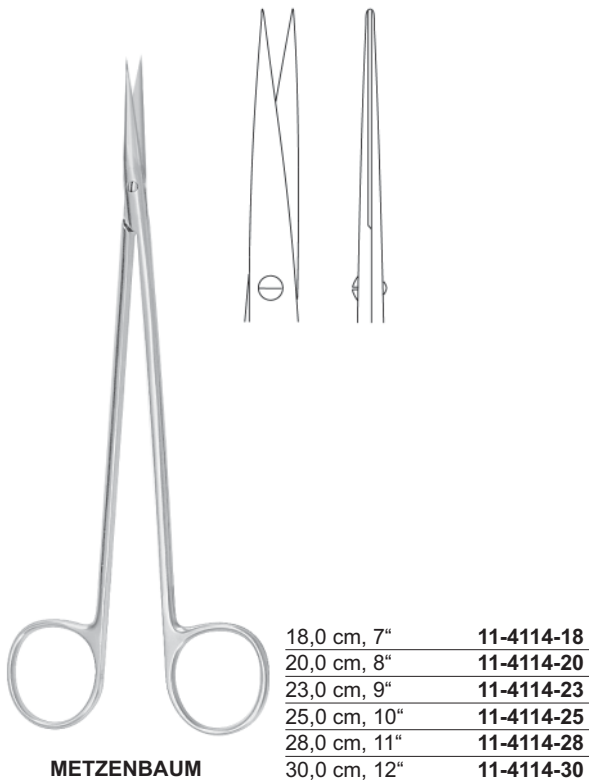

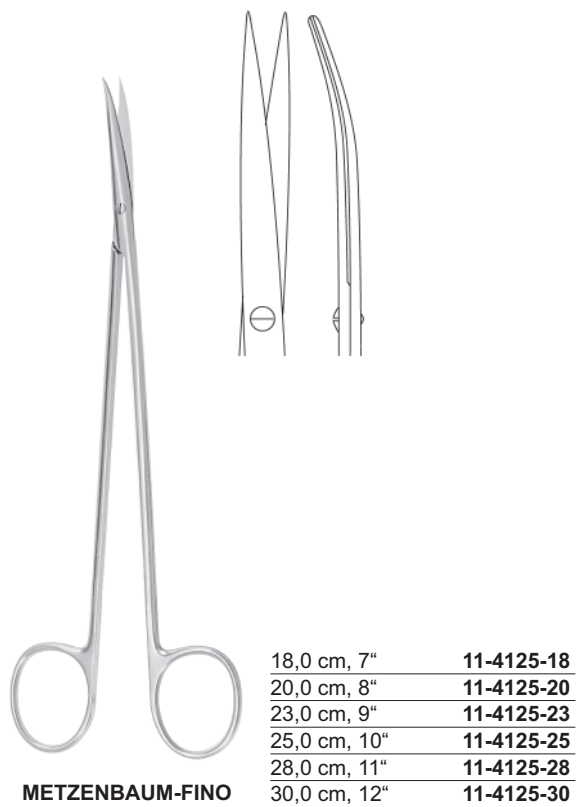
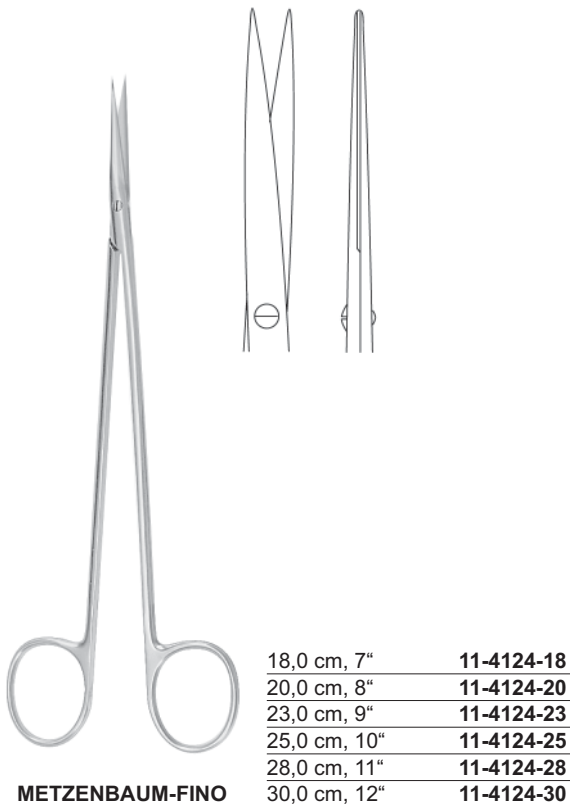
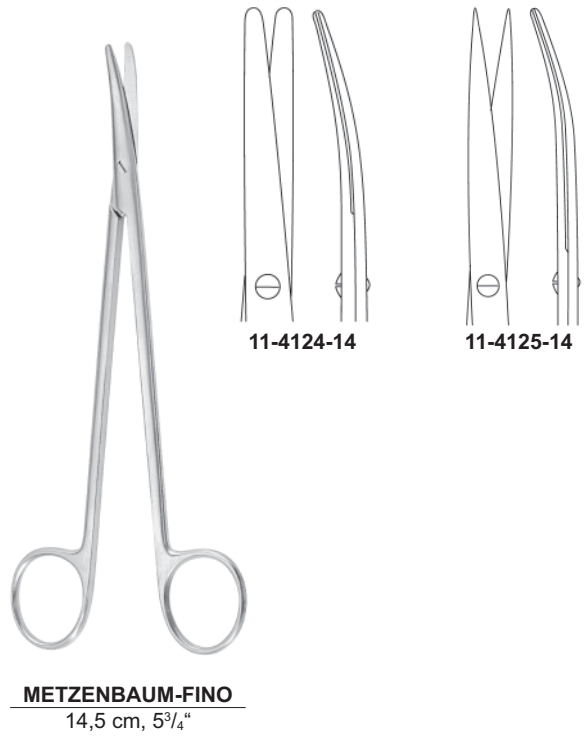
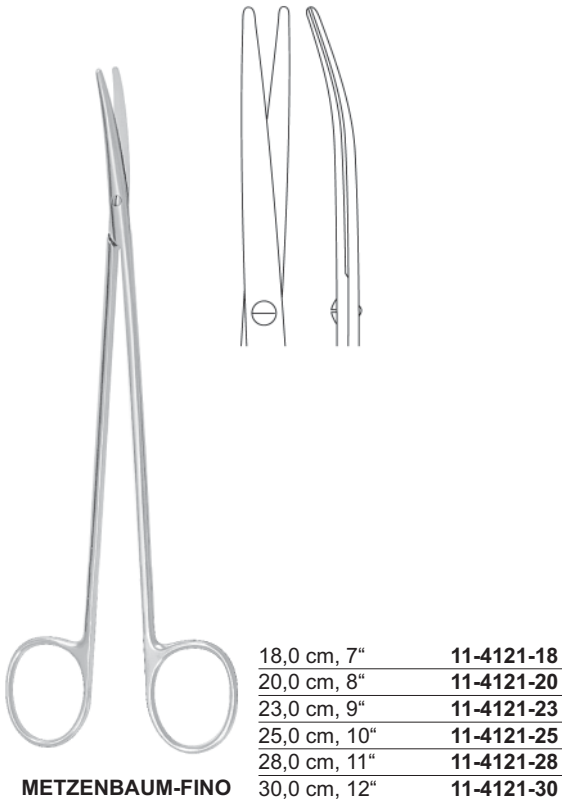

Präparierscheren
Dissecting Scissors
Tijeras de disección
Forbici per dissezione

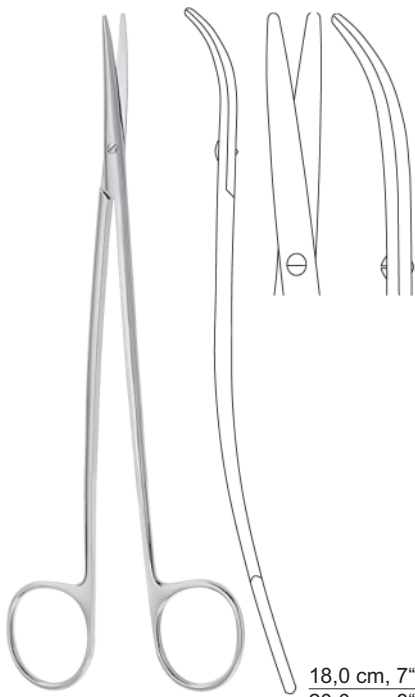

METZENBAUM-FINO S

18,0 cm, 7"	11-4127-18
20,0 cm, 8"	11-4127-20
23,0 cm, 9"	11-4127-23

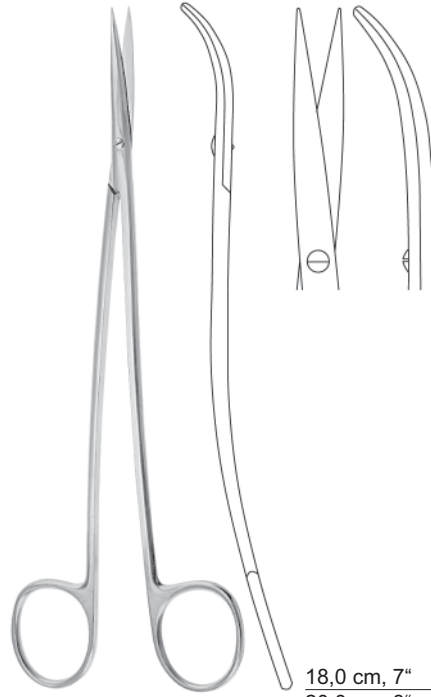

METZENBAUM-FINO S

18,0 cm, 7"	11-4129-18
20,0 cm, 8"	11-4129-20
23,0 cm, 9"	11-4129-23



METZENBAUM-LAHEY
14,0 cm, 5½"

11-4137-14

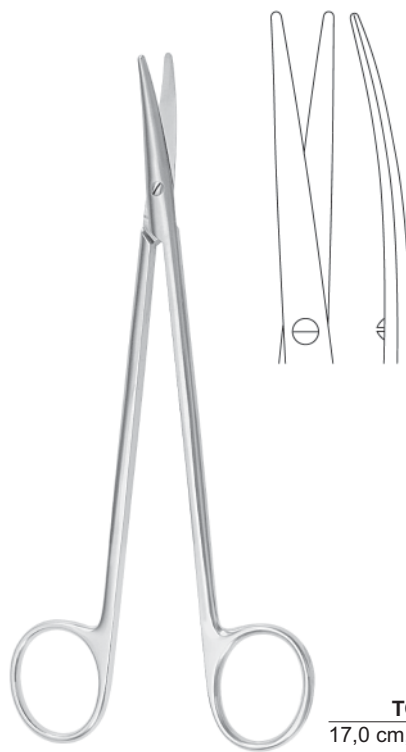

TOENNIS-ADSON

17,0 cm, 6¾"

11-4139-17

Präparierscheren
 Dissecting Scissors
 Tijeras de disección
 Forbici per dissezione

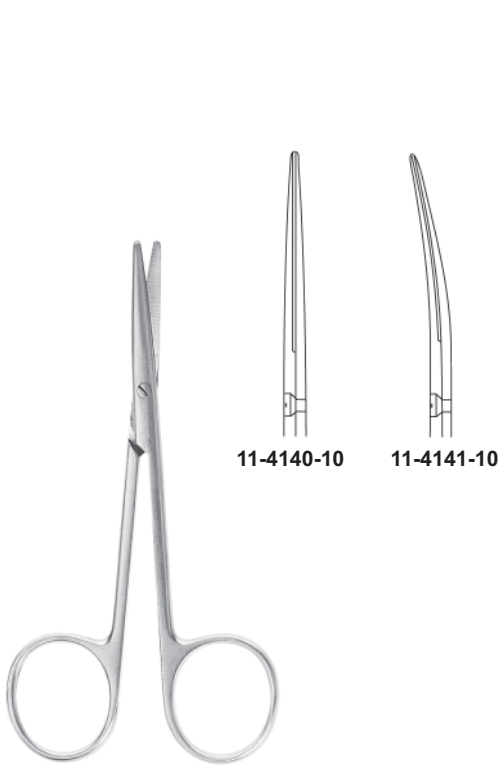

BABY-LEXER
 10,0 cm, 4"



LEXER
 16,0 cm, 6¹/₄" **11-4140-16**
 21,0 cm, 8¹/₄" **11-4140-21**



LEXER
 16,0 cm, 6¹/₄" **11-4141-16**
 21,0 cm, 8¹/₄" **11-4141-21**

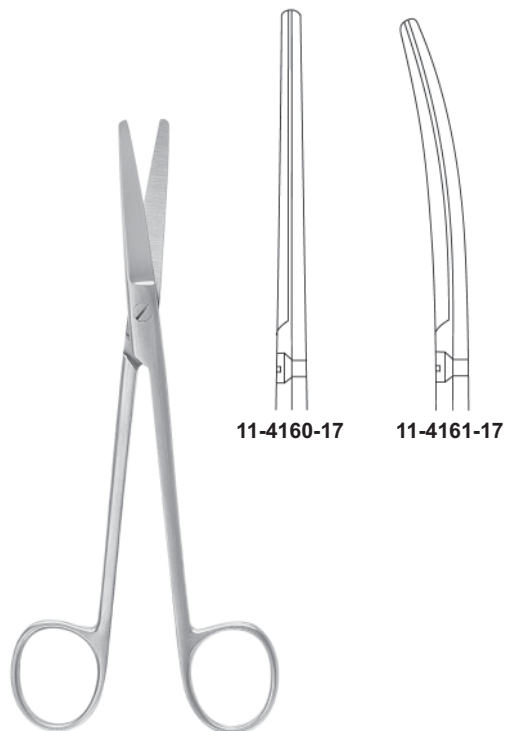

MIXTER
 17,0 cm, 6³/₄"

Präparierscheren, feine chirurgische Scheren
Dissecting Scissors, fine surgical scissors
Tijeras de disección, tijeras finas para cirugía
Forbici per dissezione, forbici fine per chirurgia



12,0 cm, 4 ³ / ₄ "	11-4200-12
15,0 cm, 6"	11-4200-15
18,0 cm, 7"	11-4200-18
20,0 cm, 8"	11-4200-20

KILNER (RAGNELL)



12,0 cm, 4 ³ / ₄ "	11-4201-12
15,0 cm, 6"	11-4201-15
18,0 cm, 7"	11-4201-18
20,0 cm, 8"	11-4201-20

KILNER (RAGNELL)



15,0 cm, 6"	11-4210-15
18,0 cm, 7"	11-4210-18

REYNOLDS



15,0 cm, 6"	11-4211-15
18,0 cm, 7"	11-4211-18
20,0 cm, 8"	11-4211-20
23,0 cm, 9"	11-4211-23
25,0 cm, 10"	11-4211-25

REYNOLDS

Feine chirurgische Scheren
 Fine surgical scissors
 Tijeras finas para cirugía
 Forbici fine per chirurgia



THOREK

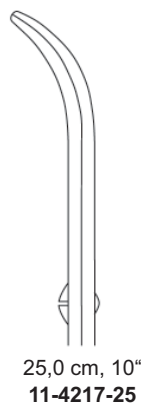
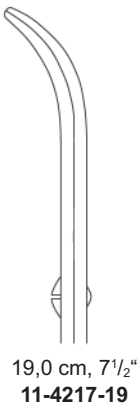

15,0 cm, 6"

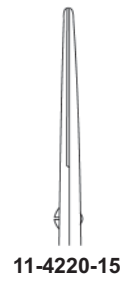

Nerv-Präparierscheren
 Nerve dissecting scissors
 Tijeras para nervios
 Forbici per dissezione di nervi



SANVENERO
 14,0 cm, 5½"

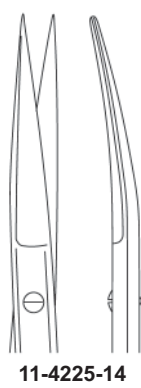

JOSEPH
 14,0 cm, 5½"

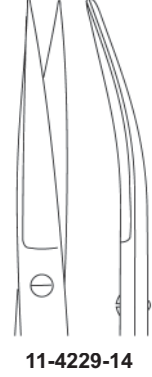

Feine chirurgische Scheren
 Fine surgical scissors
 Tijeras finas para cirugía
 Forbici fine per chirurgia



WAGNER
 12,0 cm, 4³/₄"



STRABISMUS
 11,5 cm, 4¹/₂"



IRIS

9,0 cm, 4 ¹ / ₈ "	11-4244-09
10,5 cm, 4 ¹ / ₈ "	11-4244-10
11,5 cm, 4 ¹ / ₂ "	11-4244-11

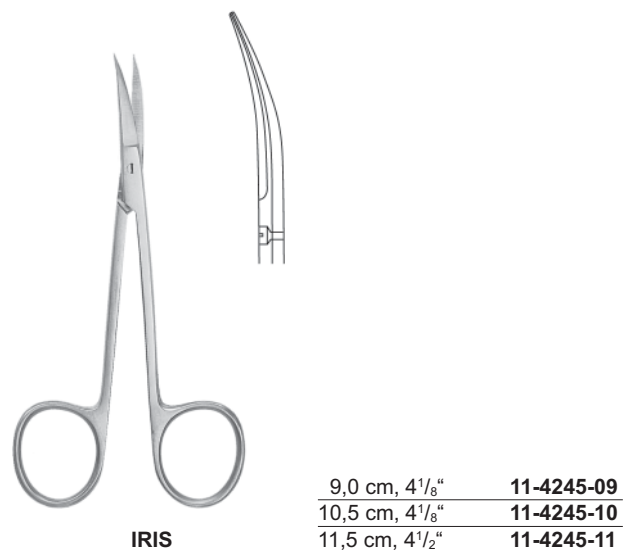

IRIS

9,0 cm, 4 ¹ / ₈ "	11-4245-09
10,5 cm, 4 ¹ / ₈ "	11-4245-10
11,5 cm, 4 ¹ / ₂ "	11-4245-11

Feine chirurgische Scheren
 Fine surgical scissors
 Tijeras finas para cirugía
 Forbici fine per chirurgia



IRIS

10,5 cm, 4¹/₈" **11-4250-10**
 11,5 cm, 4¹/₂" **11-4250-11**



IRIS

10,5 cm, 4¹/₈" **11-4251-10**
 11,5 cm, 4¹/₂" **11-4251-11**



11,5 cm, 4¹/₂"
11-4261-11



11,5 cm, 4¹/₂"
11-4263-11

Feine chirurgische Scheren
Fine surgical scissors
Tijeras finas para cirugía
Forbici fine per chirurgia



11-4264-12

12,0 cm, 4³/₄"



11-4265-12



MOD. BONN
 8,0 cm, 3¹/₄"
11-4270-08



MOD. BONN
 8,0 cm, 3¹/₄"
11-4271-08



MOD. BONN
 8,0 cm, 3¹/₄"
11-4273-08

Feine chirurgische Scheren
 Fine surgical scissors
 Tijeras finas para cirugía
 Forbici fine per chirurgia

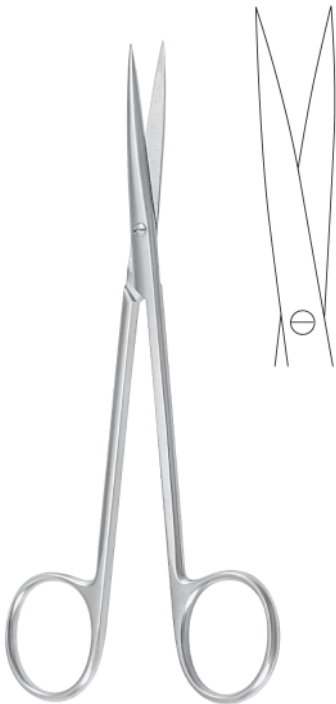

BROPHY (SULLIVAN)
 14,0 cm, 5½"
 11-4276-14



BROPHY (SULLIVAN)
 14,0 cm, 5½"
 11-4277-14



10,5 cm, 4⅛"	11-4290-10	11-4291-10	11-4294-10	11-4295-10
11,5 cm, 4½"	11-4290-11	11-4291-11	11-4294-11	11-4295-11

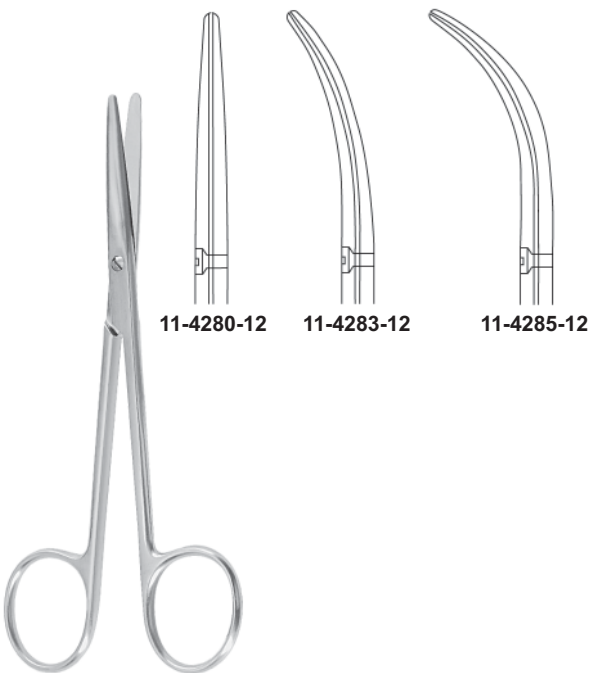

LANDOLT
 12,5 cm, 5"



STEVENS

Chirurgische Scheren
Surgical scissors
Tijeras para cirugía
Forbici per chirurgia



Inzisionsscheren
 Incision scissors
 Tijeras para incisión
 Forbici vascolare e per fistole

13,0 cm, 5" **11-4300-13**
 14,5 cm, 5³/₄" **11-4300-14**



Inzisionsscheren
 Incision scissors
 Tijeras para incisión
 Forbici vascolare e per fistole

11-4302-16
 16,5 cm, 36¹/₂"



RICHTER
 14,5 cm, 5³/₄"
11-4310-14



LAWSON TAIT
 12,5 cm, 5"
11-4312-12



FERGUSON
 16,5 cm, 6¹/₄" **11-4315-16**
 18,0 cm, 7" **11-4315-18**



TOENNIS
 18,0 cm, 7"
11-4324-18

Chirurgische Scheren, Ligaturscheren
 Surgical scissors, Ligature Scissors
 Tijeras para cirugía, Tijeras para ligaduras
 Forbici per chirurgia, Forbici per legature



TOENNIS
 18,0 cm, 7"
 11-4325-18



HALLE
 19,0 cm, 7½"
 11-4341-19

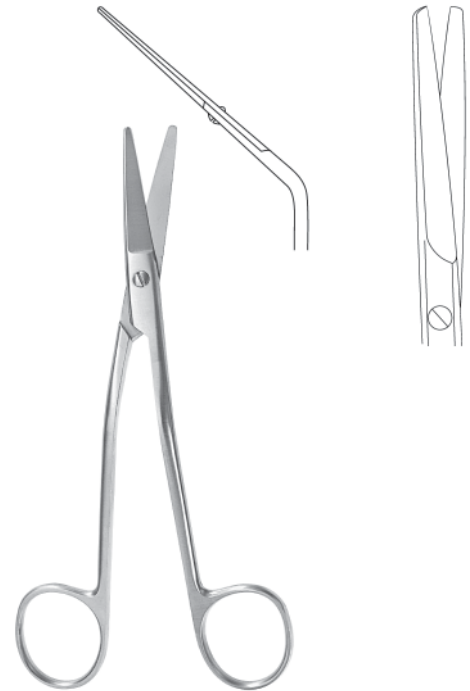

FOMON
 15,0 cm, 6"
 11-4343-15



SPENCER
 9,0 cm, 4⅞"
 11-4400-09
 10,5 cm, 4⅞"
 11-4400-10
 13,0 cm, 5"
 11-4400-13



LITTAUER
 11,5 cm, 4¼"
 11-4402-11
 14,0 cm, 5½"
 11-4402-14

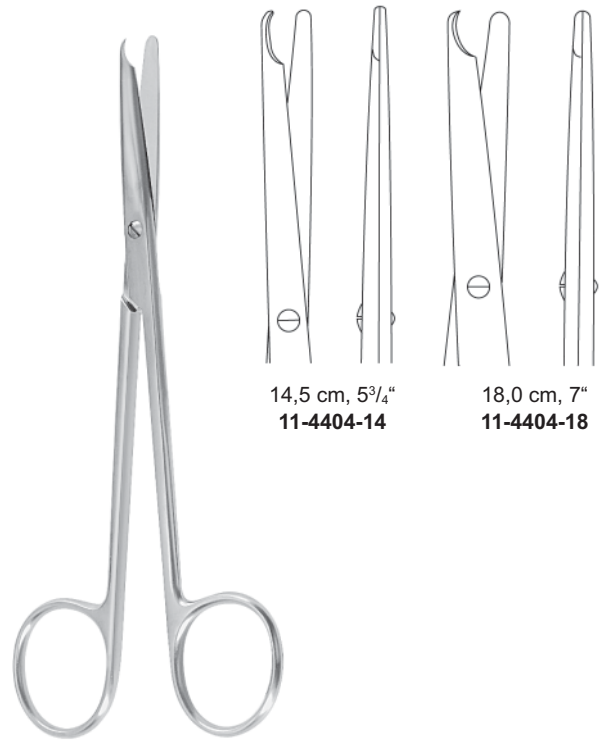

BUCK

14,5 cm, 5¾"
 11-4404-14

18,0 cm, 7"
 11-4404-18

Ligaturscheren, Neurochirurgische Scheren
Ligature Scissors, Neurosurgical Scissors
Tijeras para ligaduras, Tijeras para Neurocirugía
Forbici per legature, Forbici per Neurochirurgia

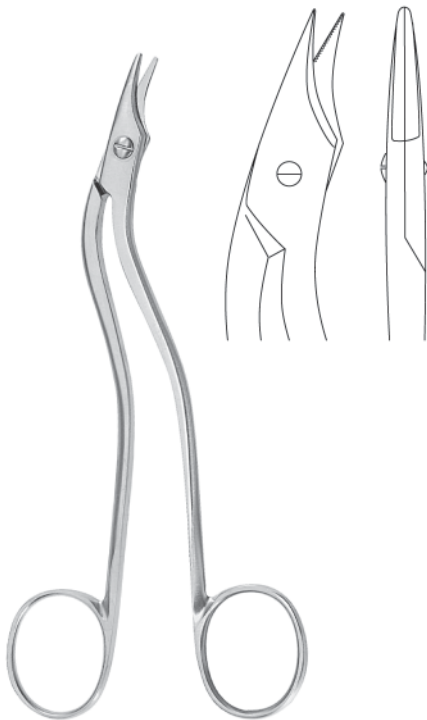

HEATH
 16,0 cm, 6¹/₄"
 11-4408-16



NORTHBENT
 9,0 cm, 3¹/₂"
 11-4411-19



NORTHBENT
 13,0 cm, 5"
 11-4413-13



EISELSBERG
 12,0 cm, 4³/₄"
 11-4415-12

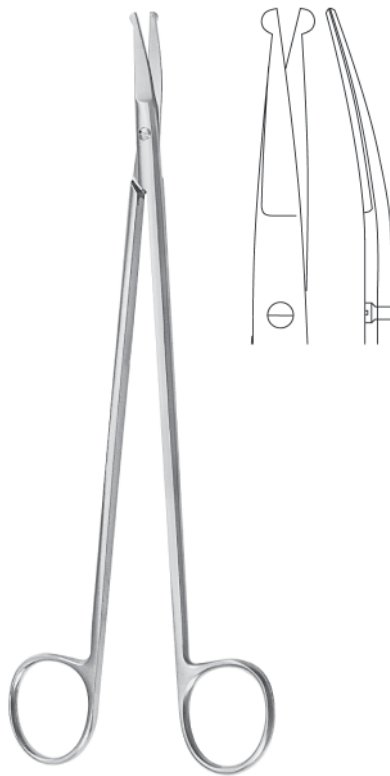

STRULLY
 22,0 cm, 8⁵/₈"
 11-4450-22

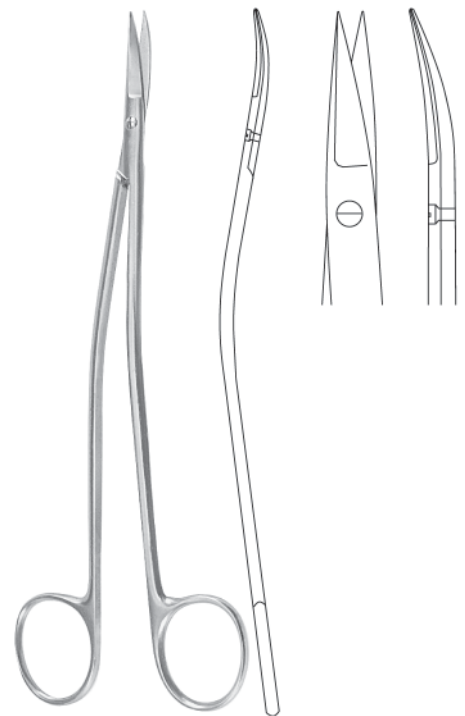

DANDY
 17,0 cm, 6³/₄"
 11-4453-17

Neurochirurgische Scheren, Tonsillenscheren, Nasenscheren
 Neurosurgical Scissors, Tonsil Scissors, Nasal Scissors
 Tijeras para Neurocirugía, Tijeras para amígdalas, Tijeras para el tabique nasal
 Forbici per Neurochirurgia, Forbici per tonsille, Forbici per il setto nasale

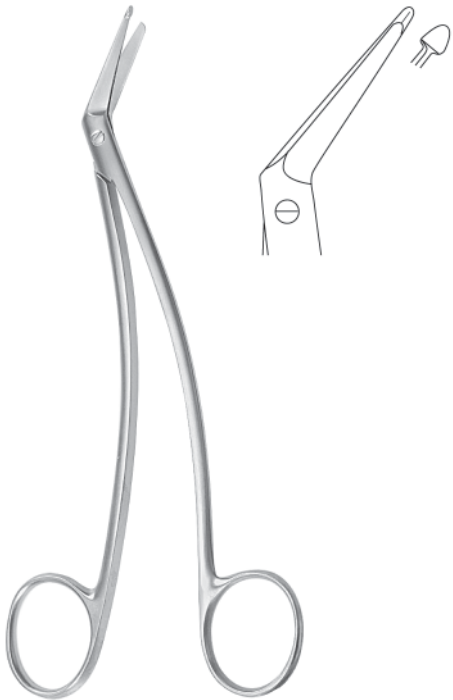

SCHMIEDEN-TAYLOR
 17,0 cm, 6³/₄"
 11-4457-17

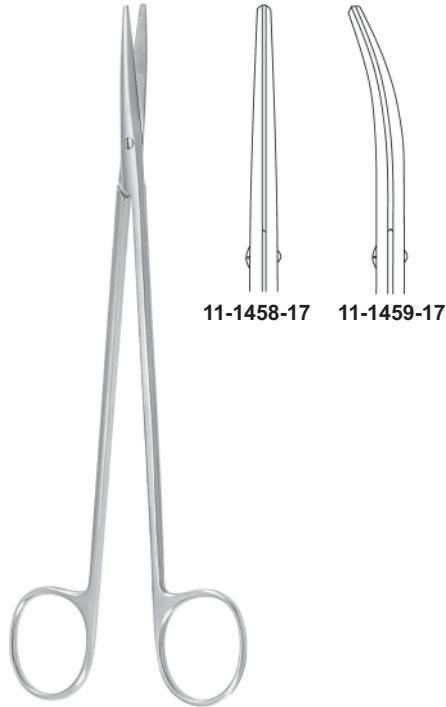

LINCOLN
 17,0 cm, 6³/₄"



HEYMANN
 18,0 cm, 7"
 11-4501-18

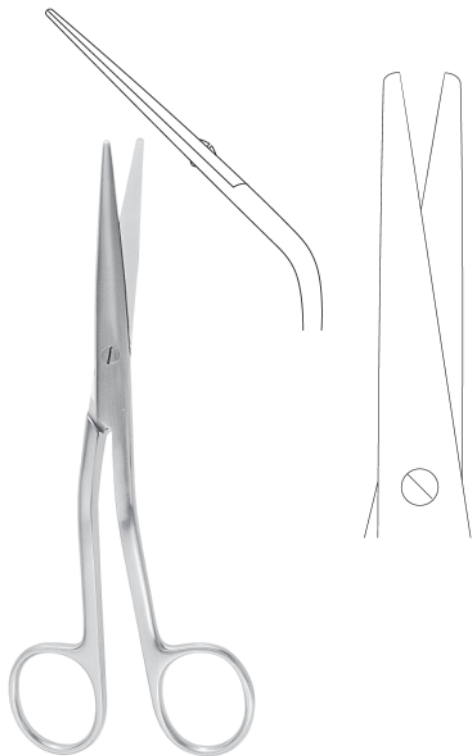

COTTLE
 16,0 cm, 6¹/₄"
 11-4511-16



KIRSTEN
 18,0 cm, 7"
 11-4517-18



CAPLAN
 22,0 cm, 8⁵/₈"
 11-4519-22

Tonsillenscheren, Nasenscheren, Gefäßscheren
Tonsil Scissors, Nasal Scissors, Vascular Scissors
Tijeras para amígdalas, Tijeras para el tabique nasal, Tijeras vasculares
Forbici per tonsille, Forbici per il setto nasale, Forbici vascolari



BOETTCHER
 18,0 cm, 7"
 11-4521-18

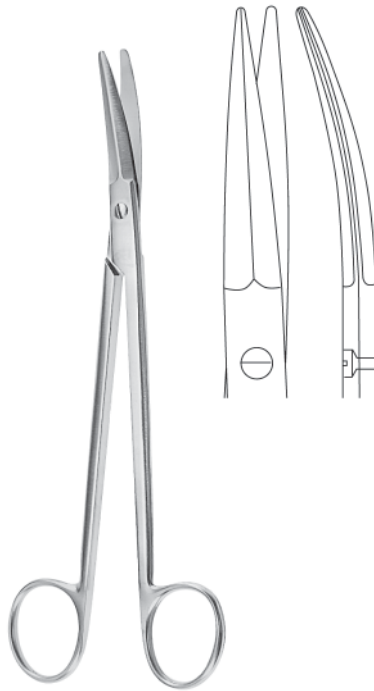

PRINCE
 17,5 cm, 6⁵/₈"
 11-4523-17

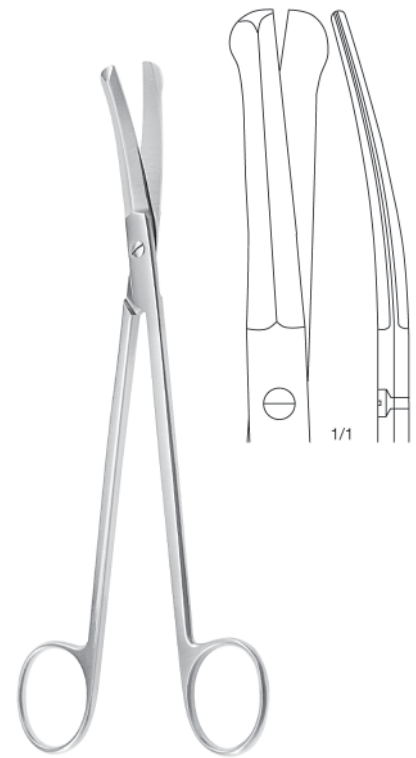

GOOD
 19,0 cm, 7¹/₂"
 11-4525-19



CARTILAGE
 20,0 cm, 8"
 11-4528-20

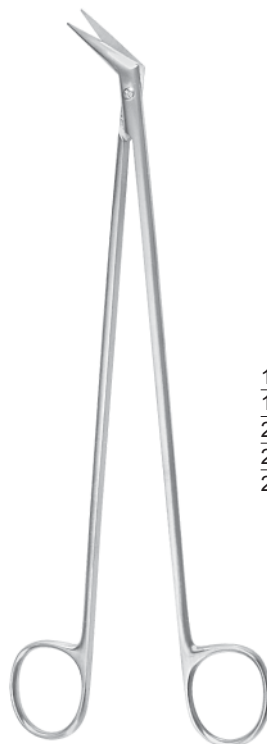

DE BAKEY

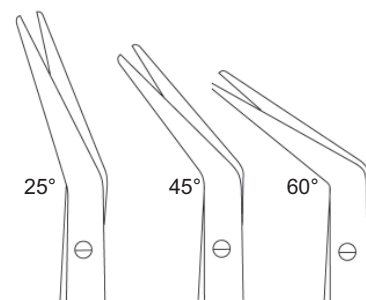

17,5 cm, 6 ⁵ / ₈ "	11-4540-25	11-4540-45	11-4540-60
19,5 cm, 7 ³ / ₄ "	11-4541-25	11-4541-45	11-4541-60
21,0 cm, 8 ¹ / ₄ "	11-4542-25	11-4542-45	11-4542-60
23,0 cm, 9"	11-4543-25	11-4543-45	11-4543-60
28,0 cm, 11"	11-4544-25	11-4544-45	11-4544-60



POTTS-SMITH
 18,0 cm, 7"
 11-4547-18

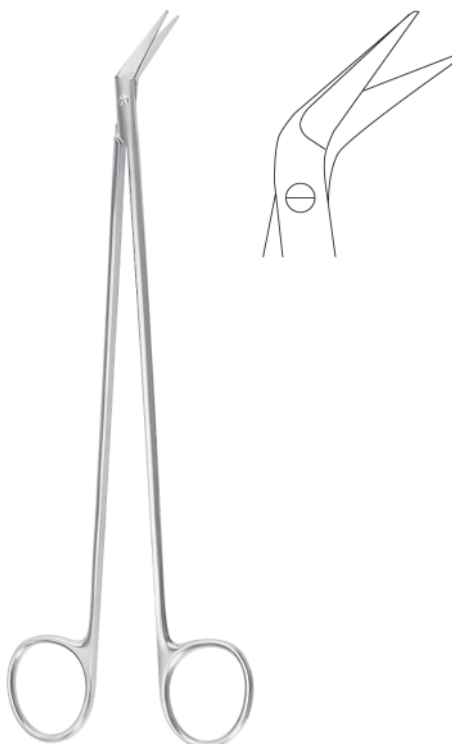

POTTS DE MARTEL
 21,0 cm, 8¹/₄" 11-4548-21
 24,0 cm, 9¹/₂" 11-4548-24



DIETRICH-HEGEMANN
 19,0 cm, 7¹/₂"

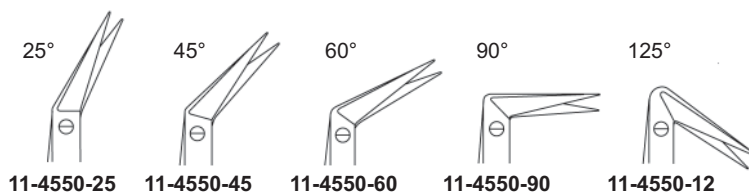

Gefäßscheren
Vascular Scissors
Tijeras vasculares
Forbici vascolari



DIETRICH
 20,0 cm, 7 1/2"
 11-4552-12

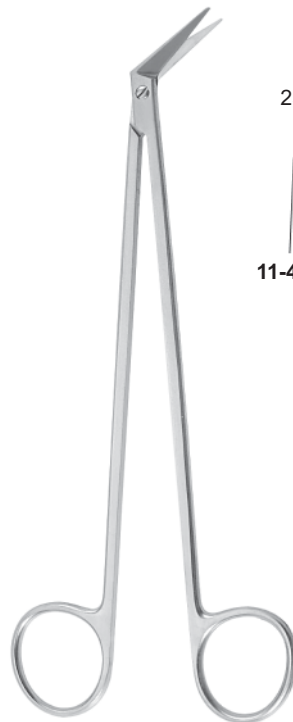

POTTS-SMITH
 19,0 cm, 7 1/2"

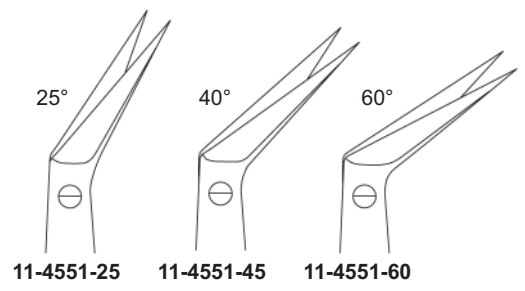

11-4551-25

11-4551-45

11-4551-60

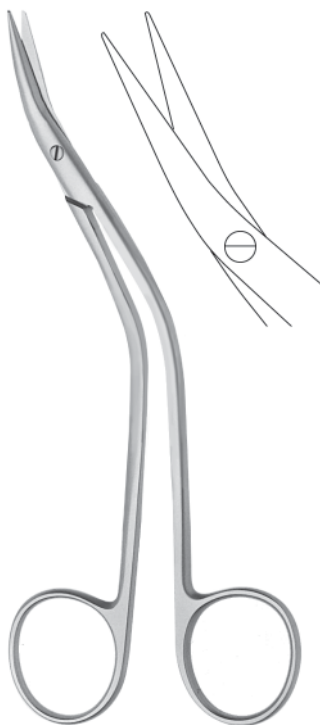

DE BAKEY
 15,5 cm, 6"
 11-4560-15

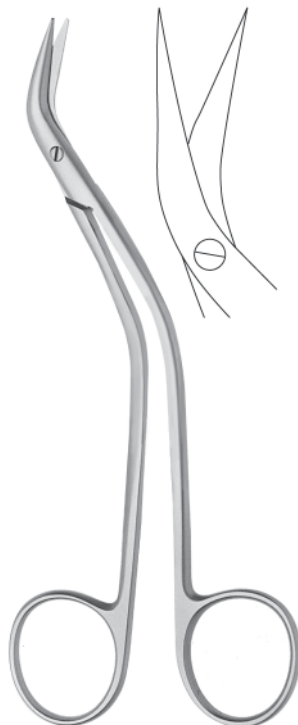

DE BAKEY
 15,5 cm, 6"
 11-4561-15



DE BAKEY
 15,5 cm, 6"
 11-4562-15

Gefäßscheren, Gynäkologische Scheren
 Vascular Scissors, Gynecology scissors
 Tijeras vasculares, Tijeras para ginecología
 Forbici vascolari, Forbici per ginecologia



MC INDOE
 19,0 cm, 7½"
 11-4570-19



geknöpftes Blatt
 probe-pointed blade
 punta botonda
 lame bottonuta

11,5 cm, 4½"
 11-4572-11



CRAFOORD
 30,0 cm, 12"
 11-4575-30



SATINSKY
 15,5 cm, 9⅝"
 11-4577-24



KLINGENBERG-LOTH
 23,0 cm, 9"
 11-4579-23



SIMS

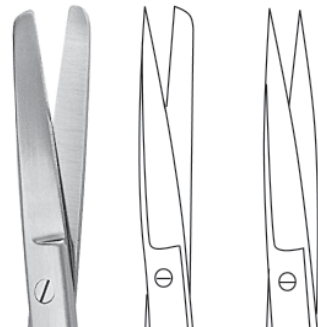

20,0 cm, 8"	11-4600-20	11-4602-20	11-4604-20
23,0 cm, 9"	11-4600-23	11-4602-23	11-4604-23

Gynäkologische Scheren
 Gynecology scissors
 Tijeras para ginecología
 Forbici per ginecologia



SIMS

20,0 cm, 8"	11-4601-20	11-4603-20	11-4605-20
23,0 cm, 9"	11-4601-23	11-4603-23	11-4605-23

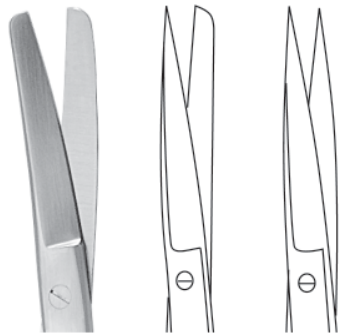

SIEBOLD
 24,0 cm, 9 1/2"
11-4620-24



BOZEMANN
 22,0 cm, 8 3/4"
11-4622-22



DOYEN

16,0 cm, 6 1/4"	11-4610-16	11-4611-16	11-4612-16
17,5 cm, 6 5/8"	11-4610-17	11-4611-17	



Fistelscheren
 Fistula scissors
 Tijeras para fistulas
 Forbici per fistole

KELLY

16,0 cm, 6 1/4"	11-4634-16
18,0 cm, 7"	11-4634-18

Gynäkologische Scheren, Darmscheren
 Gynecology scissors, Enterotomy Scissors
 Tijeras para ginecología, Tijeras enterótomos
 Forbici per ginecologia, Forbici per enterotomia



Fistelscheren
 Fistula scissors
 Tijeras para fistulas
 Forbici per fistole

KELLY

16,0 cm, 6¹/₄" **11-4635-16**
 18,0 cm, 7" **11-4635-18**



WERTHEIM

19,5 cm, 7³/₄" **11-4640-19**
 22,5 cm, 8³/₄" **11-4640-23**



11-4651-18

DUBOIS

27,0 cm, 10⁵/₈"
11-4650-18



21,0 cm, 8¹/₄"
11-4670-21



21,0 cm, 8¹/₄"
11-4672-21



21,0 cm, 8¹/₄"
11-4674-21



LLOYD-DAVIES
 27,0 cm, 10⁵/₈"
11-4677-27



Lungenlappen- und Rektumscheren, Lungenscheren, Dammscheren
Lobectomy and Rectal Scissors, Lobectomy Scissors, Episiotomy Scissors
Tijeras para lobectomía y recto, Tijera para lobectomía, Tijeras para episiotomía
Forbici per lobo polmonare e per il retto, Forbici per lobo, Forbici per episiotomia

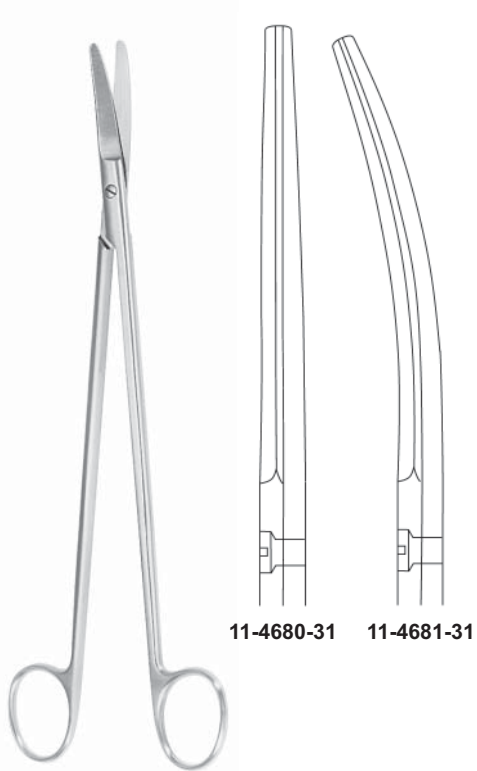

11-4680-31 11-4681-31

STELZNER
31,0 cm, 12¹/₄"

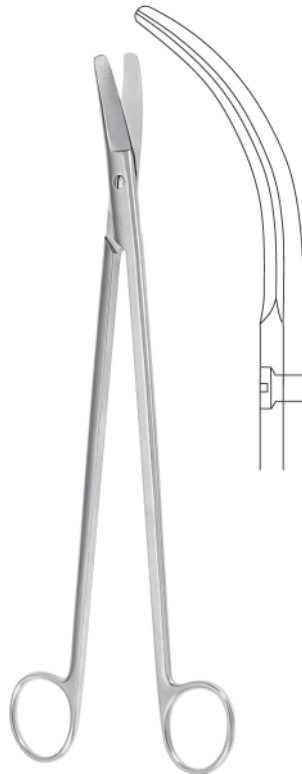

RECTAL
32,5 cm, 12³/₄"
11-4685-32

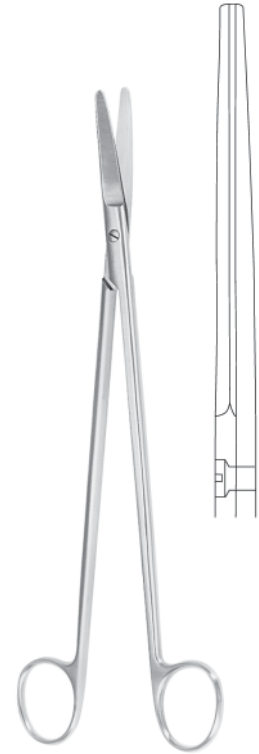

WILLAUER
25,0 cm, 9³/₄" **11-4688-25**
28,0 cm, 11" **11-4688-28**

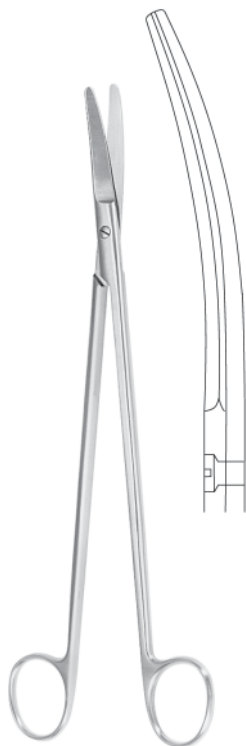

WILLAUER
25,0 cm, 9³/₄" **11-4689-25**
28,0 cm, 11" **11-4689-28**



POTTS-SMITH
19,0 cm, 7¹/₂"
11-4691-19



FINOCHIETTO
32,5 cm, 10⁵/₈"
11-4693-27

Lungenscheren, Dammscheren, Nabelschnurscheren
 Lobectomy Scissors, Episiotomy Scissors, Umbilical Cord Scissors
 Tijera para lobectomía, Tijeras para episiotomía, Tijeras umbilicales
 Forbici per lobo, Forbici per episiotomia, Forbici ombelicali



WALDMANN
 18,0 cm, 7"
 11-4695-18



BRAUN-STADLER
 14,5 cm, 5³/₄" 11-4701-14
 20,0 cm, 8" 11-4701-20



20,0 cm, 8"
 11-4703-20



MOD. USA
 10,5 cm, 4¹/₈"
 11-4706-10



BUSCH
 13,5 cm, 5³/₈" 11-4707-13
 16,0 cm, 6¹/₄" 11-4707-16



SCHUMACHER
 16,0 cm, 16¹/₄"
 11-4709-16

Drahtscheren, Verband- und Kleiderstoffscheren
Wire Scissors, Bandage and Cloth Scissors
Cizallas corta-alambres, Tijeras para vendajes y tela
Forbici taglia cavo, Forbici per bendaggi e vestiti



gezahnt
serrated
dentada
dentata

UNIVERSAL
12,0 cm, 4³/₄"
11-4800-12



LISTER

9,0 cm, 3 ¹ / ₂ "	11-4900-09
11,0 cm, 4 ³ / ₈ "	11-4900-11
14,0 cm, 5 ¹ / ₂ "	11-4900-14
18,0 cm, 7"	11-4900-18
20,0 cm, 8"	11-4900-20



LISTER

18,5 cm, 7 ¹ / ₄ "	11-4901-18
21,0 cm, 8 ¹ / ₄ "	11-4901-21



gezahnt
serrated
dentada
dentata

LISTER-EXCENTRIC

16,0 cm, 6 ¹ / ₄ "	11-4903-16
19,0 cm, 7 ¹ / ₂ "	11-4903-19



BERGMANN

23,0 cm, 9"	11-4905-23
-------------	-------------------

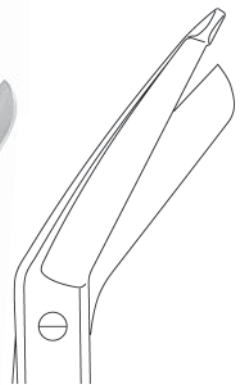

Verband- und Kleiderstoffscheren, Gipscheren
Bandage and Cloth Scissors, Plaster-of-Paris Shears
Tijeras para vendajes y tela, Cizallas para escayolas
Forbici per bendaggi e vestiti, Cesoie per gessi



ESMARCH
 20,0 cm, 8" **11-4907-20**
 22,0 cm, 8⁵/₈" **11-4907-22**



KNOWLES
 14,0 cm, 5¹/₂" **11-4920-14**



gezahnt
 serrated
 dentada
 dentata

BRUNS
 24,0 cm, 9¹/₂" **11-4909-24**
11-4910-24



LORENZ
 23,0 cm, 9" **11-4930-23**

bis 134°C autoklavierbar
 autoclavable up to 134°C
 esterilizabile en autoclave hasta 134°C
 Sterilizabile in autoclave fino 134°C



SMITH
(MOD. USA)

16,0 cm, 6¹/₄" **11-4940-16**
 18,0 cm, 7" **11-4940-18**
 20,0 cm, 8" **11-4940-20**
 23,0 cm, 9" **11-4940-23**



gezahnt
 serrated
 dentada
 dentata

20,0 cm, 8" **11-4941-20**



gezahnt
 serrated
 dentada
 dentata

UNIVERSAL
 14,0 cm, 5¹/₂" **11-4950-14**
 16,0 cm, 6¹/₄" **11-4950-16**
 18,0 cm, 7" **11-4950-18**

Chirurgische Scheren mit Hartmetallschneiden
 Surgical Scissors with tungsten carbide edges
 Tijeras para cirugía con filos de carburo tungsteno
 Forbici per chirurgia con lame in carburo di tungsteno



STANDARD

14,5 cm, 5 ³ / ₄ "	12-4000-14
16,5 cm, 6 ¹ / ₂ "	12-4000-16
18,5 cm, 7 ¹ / ₄ "	12-4000-18



STANDARD

14,5 cm, 5 ³ / ₄ "	12-4001-14
16,5 cm, 6 ¹ / ₂ "	12-4001-16
18,5 cm, 7 ¹ / ₄ "	12-4001-18



STANDARD

14,5 cm, 5 ³ / ₄ "	12-4002-14
16,5 cm, 6 ¹ / ₂ "	12-4002-16
18,5 cm, 7 ¹ / ₄ "	12-4002-18



STANDARD

14,5 cm, 5 ³ / ₄ "	12-4003-14
16,5 cm, 6 ¹ / ₂ "	12-4003-16
18,5 cm, 7 ¹ / ₄ "	12-4003-18



STANDARD

14,5 cm, 5 ³ / ₄ "	12-4004-14
16,5 cm, 6 ¹ / ₂ "	12-4004-16
18,5 cm, 7 ¹ / ₄ "	12-4004-18



STANDARD

14,5 cm, 5 ³ / ₄ "	12-4005-14
16,5 cm, 6 ¹ / ₂ "	12-4005-16
18,5 cm, 7 ¹ / ₄ "	12-4005-18

Chirurgische Scheren mit Hartmetallschneiden
 Surgical Scissors with tungsten carbide edges
 Tijeras para cirugía con filos de carburo tungsteno
 Forbici per chirurgia con lame in carburo di tungsteno



MAYO

14,5 cm, 5 ³ / ₄ "	12-4100-14
17,0 cm, 6 ³ / ₄ "	12-4100-17
23,0 cm, 9"	12-4100-23



MAYO

14,5 cm, 5 ³ / ₄ "	12-4101-14
17,0 cm, 6 ³ / ₄ "	12-4101-17
23,0 cm, 9"	12-4101-23



MAYO-STILLE

15,0 cm, 6"	12-4102-15
17,0 cm, 6 ³ / ₄ "	12-4102-17



MAYO-STILLE

15,0 cm, 6"	12-4103-15
17,0 cm, 6 ³ / ₄ "	12-4103-17



LEXER

16,0 cm, 6 ¹ / ₄ "	12-4140-16
21,0 cm, 8 ¹ / ₄ "	12-4140-21



LEXER

16,0 cm, 6 ¹ / ₄ "	12-4141-16
21,0 cm, 8 ¹ / ₄ "	12-4141-21

Präparierscheren mit Hartmetallschneiden
Dissecting Scissors with tungsten carbide edges
Tijeras para disección con filos de carburo tungsteno
Forbici per dissezione con lame in carburo di tungsteno

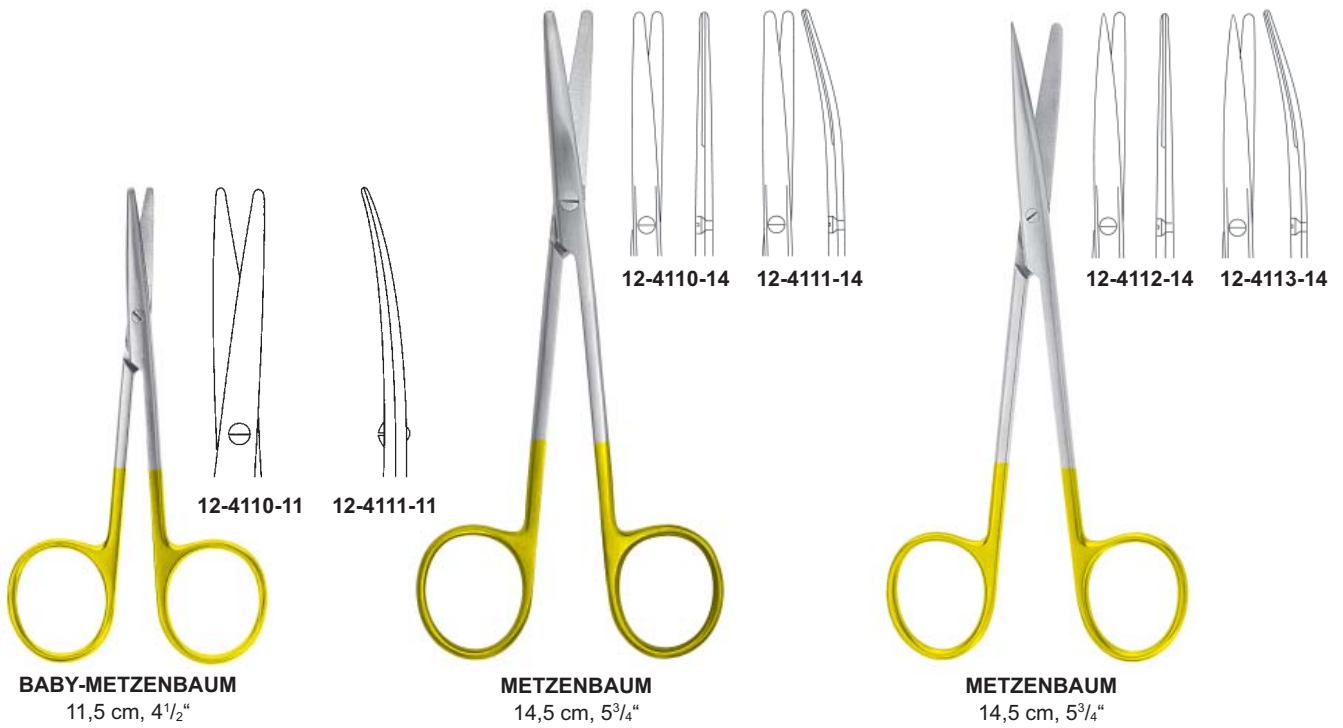

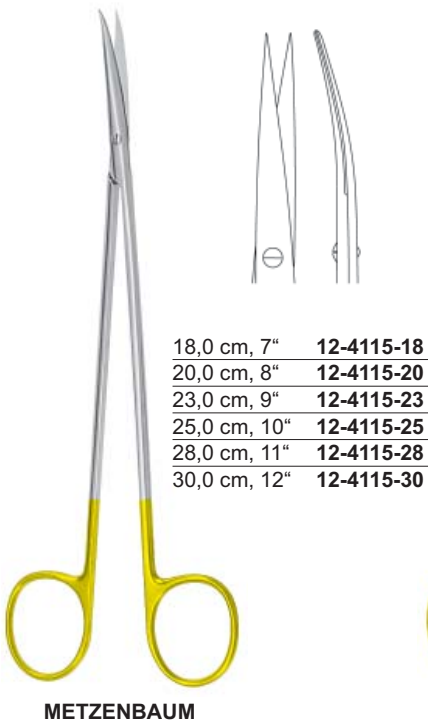
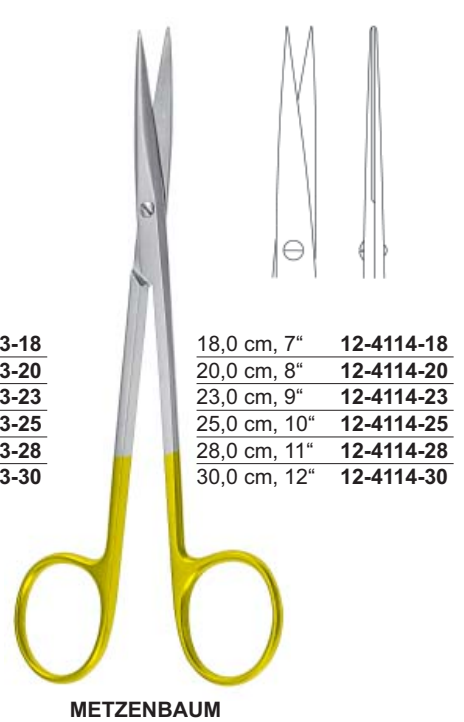
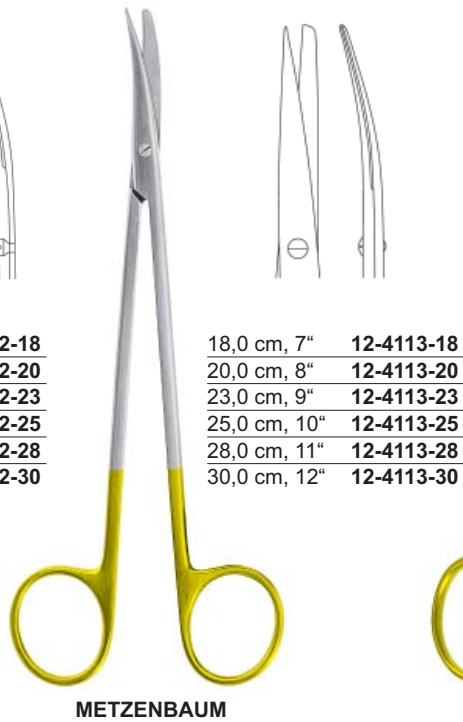

Präparierscheren mit Hartmetallschneiden
Dissecting Scissors with tungsten carbide edges
Tijeras para disección con filos de carburo tungsteno
Forbici per dissezione con lame in carburo di tungsteno

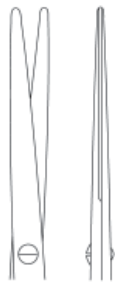

18,0 cm, 7"	12-4120-18
20,0 cm, 8"	12-4120-20
23,0 cm, 9"	12-4120-23
25,0 cm, 10"	12-4120-25
28,0 cm, 11"	12-4120-28
30,0 cm, 12"	12-4120-30

METZENBAUM-FINO

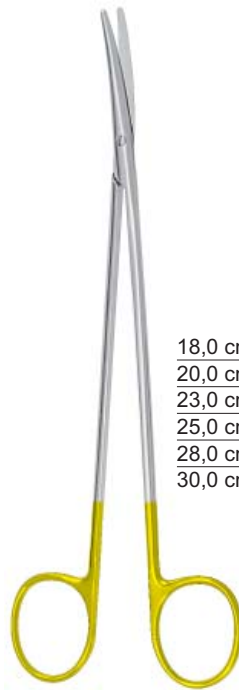

18,0 cm, 7"	12-4121-18
20,0 cm, 8"	12-4121-20
23,0 cm, 9"	12-4121-23
25,0 cm, 10"	12-4121-25
28,0 cm, 11"	12-4121-28
30,0 cm, 12"	12-4121-30

METZENBAUM-FINO



18,0 cm, 7"	12-4124-18
20,0 cm, 8"	12-4124-20
23,0 cm, 9"	12-4124-23
25,0 cm, 10"	12-4124-25
28,0 cm, 11"	12-4124-28
30,0 cm, 12"	12-4124-30

METZENBAUM-FINO



18,0 cm, 7"	12-4125-18
20,0 cm, 8"	12-4125-20
23,0 cm, 9"	12-4125-23
25,0 cm, 10"	12-4125-25
28,0 cm, 11"	12-4125-28
30,0 cm, 12"	12-4125-30

METZENBAUM-FINO

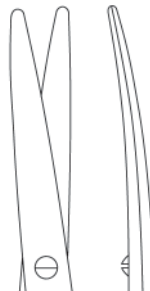

METZENBAUM-LAHEY
 14,0 cm, 5½"
12-4137-14

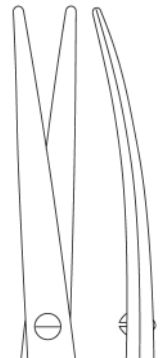

TOENNIS-ADSON
 17,0 cm, 6¾"
12-4139-17

Präparierscheren mit Hartmetallschneiden
 Dissecting Scissors with tungsten carbide edges
 Tijeras para disección con filos de carburo tungsteno
 Forbici per dissezione con lame in carburo di tungsteno

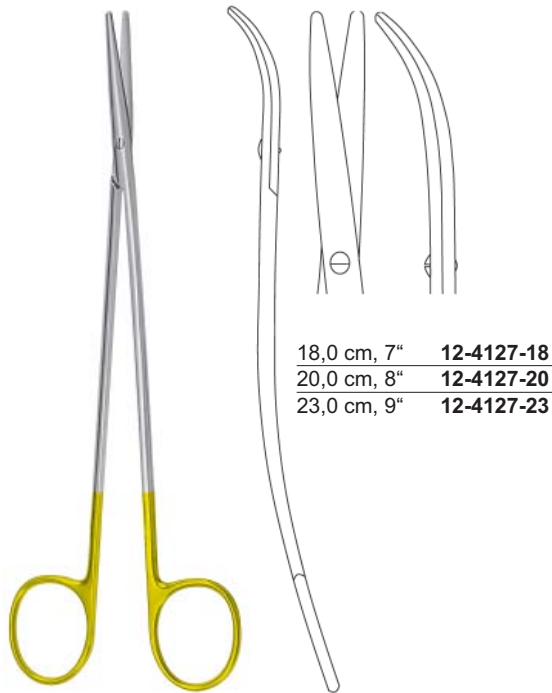

18,0 cm, 7"	12-4127-18
20,0 cm, 8"	12-4127-20
23,0 cm, 9"	12-4127-23

METZENBAUM-FINO S

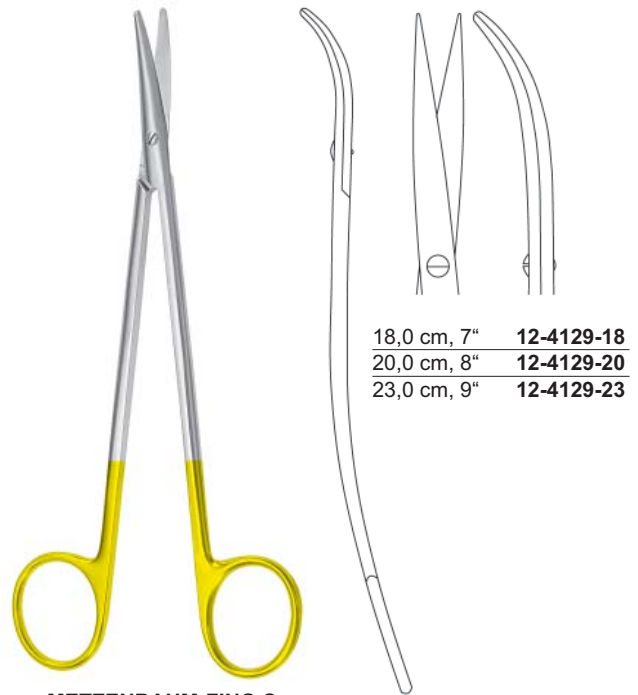

18,0 cm, 7"	12-4129-18
20,0 cm, 8"	12-4129-20
23,0 cm, 9"	12-4129-23

METZENBAUM-FINO S



REYNOLDS
 15,0 cm, 6"
 12-4210-15



REYNOLDS
 15,0 cm, 6"
 12-4211-15



HYSTEREKTOMY
 25,5 cm, 10"
 12-4663-25



HYSTEREKTOMY
 25,0 cm, 9 3/4"
 12-4665-25

Gynäkologische Scheren mit Hartmetallschneiden
 Gynecology Scissors with tungsten carbide edges
 Tijeras para ginecología con filos de carburo tungsteno
 Forbici per ginecologia con lame in carburo di tungsteno



SIMS



20,0 cm, 8"	12-4600-20	12-4602-20	12-4604-20
23,0 cm, 9"	12-4600-23	12-4602-23	12-4604-23



SIMS



20,0 cm, 8"	12-4601-20	12-4603-20	12-4605-20
23,0 cm, 9"	12-4601-23	12-4603-23	12-4605-23

Gefäßscheren mit Hartmetallschneiden
 Vascular Scissors with tungsten carbide edges
 Tijeras vasculares con filos de carburo tungsteno
 Forbici vascolari con lame in carburo di tungsteno



DIETRICH
 17,5 cm, 6⁵/₈"
 12-4552-17



POTTS DE MARTEL
 24,0 cm, 9¹/₂"
 12-4548-24



DE BAKEY

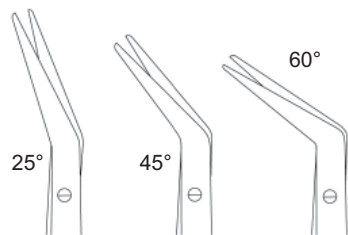

20,0 cm, 8"	12-4543-25	12-4543-45	12-4543-60
23,0 cm, 9"	12-4545-25	12-4545-45	12-4545-60

Gefäßscheren mit Hartmetallschneiden
Vascular Scissors with tungsten carbide edges
Tijeras vasculares con filos de carburo tungsteno
Forbici vascolari con lame in carburo di tungsteno

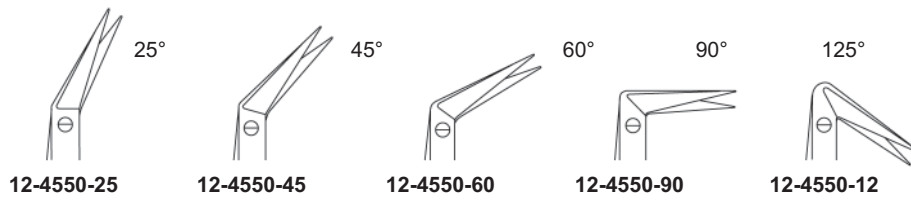

DIETRICH-HEGEMANN
 18,0 cm, 7"

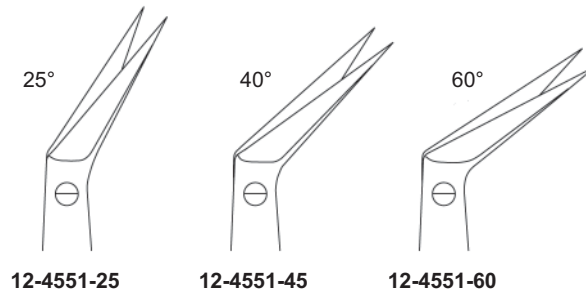

POTTS-SMITH
 18,0 cm, 7 1/2"

Scheren mit Hartmetallschneiden
 Scissors with tungsten carbide edges
 Tijeras con filos de carburo tungsteno
 Forbici con lame in carburo di tungsteno



12-4244-11 42-1245-11

IRIS
 11,5 cm, 4½"



gezahnt
 serrated
 dentada
 dentata

UNIVERSAL
 12,0 cm, 4¾"
 12-4800-12



LISTER
 18,0 cm, 7"
 12-4900-18

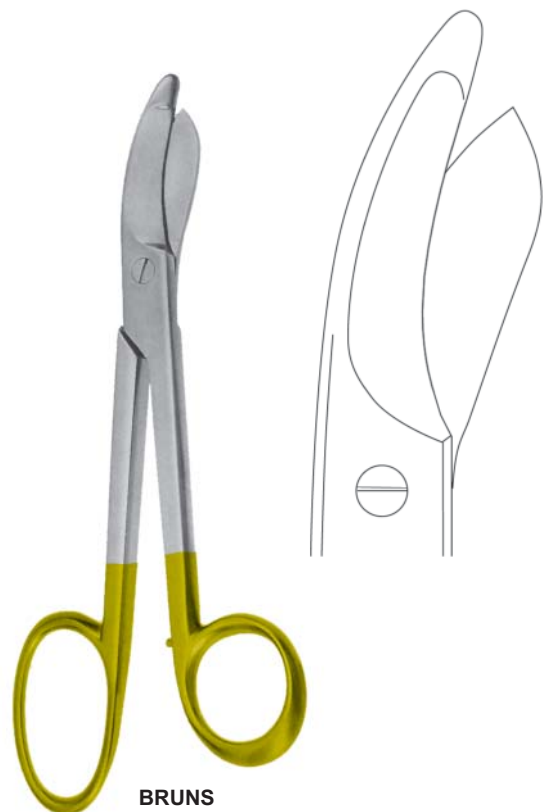

BRUNS
 24,0 cm, 9½"
 12-4909-24

Super-Cut Scheren
 Super-Cut Scissors
 Tijeras Super-Cut
 Forbici Super-Cut



MAYO
 17,0 cm, 6³/₄"

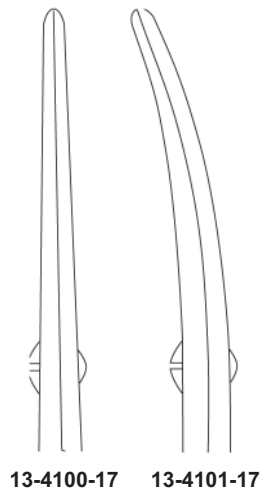

13-4100-17 13-4101-17

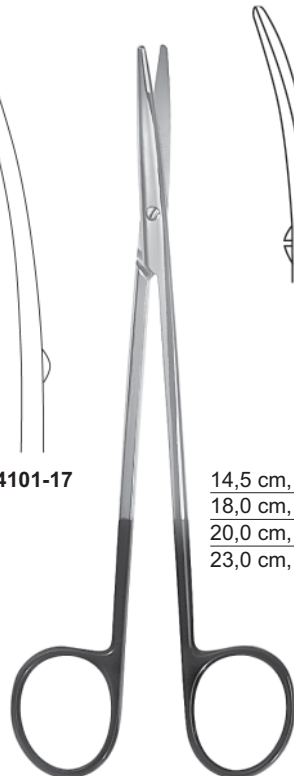

METZENBAUM

14,5 cm, 5³/₄" 13-4111-14
 18,0 cm, 7" 13-4111-18
 20,0 cm, 8" 13-4111-20
 23,0 cm, 9" 13-4111-23

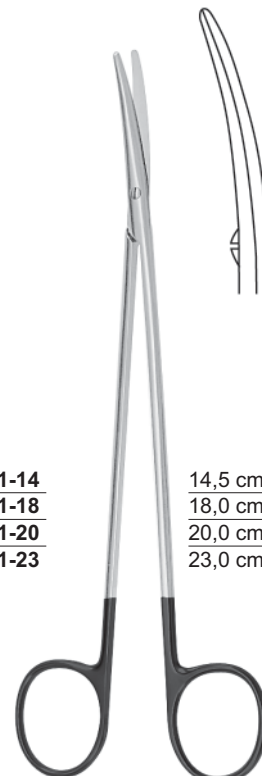

METZENBAUM-FINO

14,5 cm, 5³/₄" 13-4121-14
 18,0 cm, 7" 13-4121-18
 20,0 cm, 8" 13-4121-20
 23,0 cm, 9" 13-4121-23



KAYE FACE LIFT

15,0 cm, 6" 13-4129-15
 19,0 cm, 7¹/₂" 13-4129-19



JABALEY
 13,0 cm, 5"
 13-4130-13



ENDARTERECTOMY
 18,0 cm, 7"
 13-4133-18



TOENNIS-ADSON
 17,0 cm, 6³/₄"
 13-4139-17



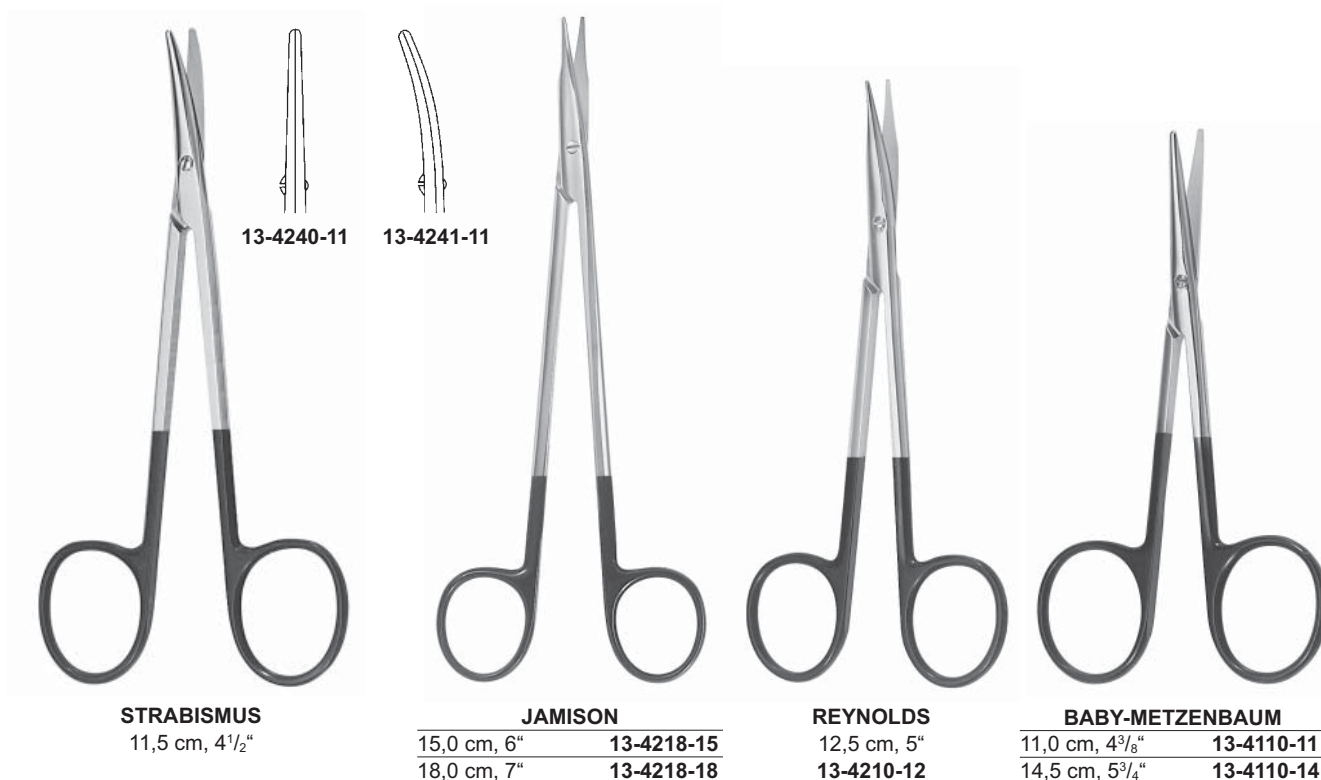

Super-Cut Scheren
 Super-Cut Scissors
 Tijeras Super-Cut
 Forbici Super-Cut



PAR TYPE
 12,0 cm, 4³/₄"
 13-4200-12



PAR TYPE
 12,0 cm, 4³/₄"
 13-4201-12

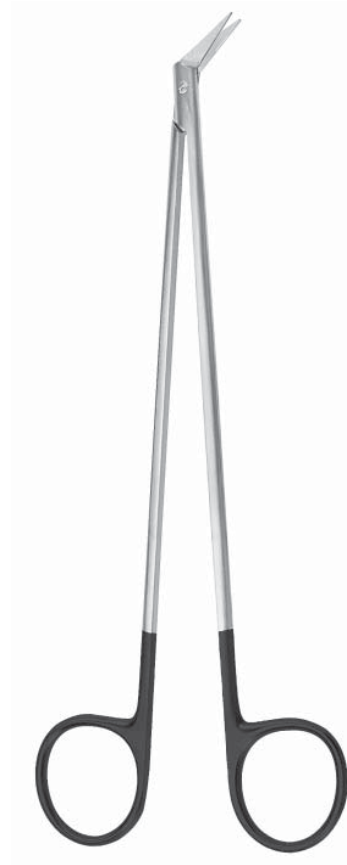

POTTS
 19,0 cm, 7¹/₂"



13-4551-25

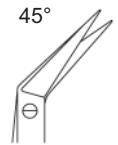

13-4551-45

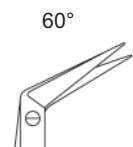

13-4551-60



FOMON
 14,5 cm, 5³/₄"
 13-4343-15



COTTLE
 16,5 cm, 6¹/₂"
 13-4511-16





WESTCOTT
11,0 cm, 4³/₈"

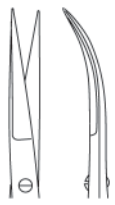

15-4081-11



15-4083-11



GOMEL

14,0 cm, 5¹/₂" **15-4241-14Z**
16,0 cm, 6¹/₄" **15-4241-16Z**



gezahnt
serrated
dentada
dentata



HEPP SCHEIDEL

14,0 cm, 5¹/₂" **15-4243-14**
16,0 cm, 6¹/₄" **15-4243-16**



Mikro-Präparierscheren
Micro-dissecting scissors
Micro-tijeras de disección
Micro-forbici per dissezione

**Mikro-Scheren
Micro Scissors
Micro-Tijeras
Micro-Forbici**

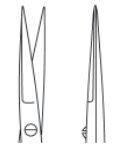
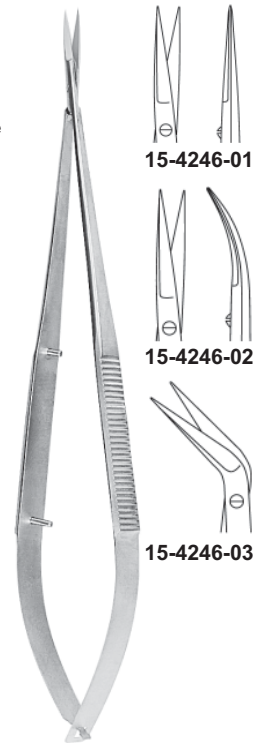

15-4246-01

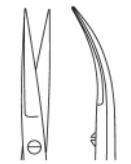

15-4246-02



15-4246-03

18,5 cm, 7¹/₄"



STEVENS



18,5 cm, 7¹/₄" **15-4290-01** **15-4290-02** **15-4290-03** **15-4290-04**
22,5 cm, 8³/₄" **15-4291-01** **15-4291-02** **15-4291-03** **15-4291-04**



18,5 cm, 7¹/₄" **15-4292-01** **15-4292-02**
22,5 cm, 8³/₄" **15-4293-01** **15-4293-02**

Mikro-Scheren, Mikro-Disektionsscheren
Micro Scissors, Micro Dissecting Scissors
Micro-Tijeras, Micro-Tijeras de disección
Micro-Forbici, Micro-Forbici per dissezione



18,0 cm, 7"



15-4270-25



15-4270-45

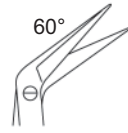

15-4270-60

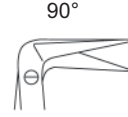

15-4270-90



15-4270-12



15-4271-25

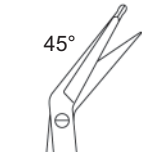

15-4271-45

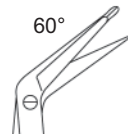

15-4271-60

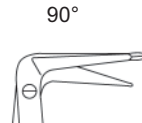

15-4271-90



15-4271-12



15,0 cm, 6"
15-4223-15



15,0 cm, 6"
15-4223-15Z



gezahnt
serrated
dentada
dentata



15,0 cm, 6"
15-4201-15



18,0 cm, 7"
15-4201-18

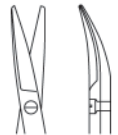

Mikro-Adventitiascheren
Micro Adventitia Scissors
Micro-Tijeras Adventitia
Micro-Forbici Adventitia



15,0 cm, 6"
15-4232-15



15,0 cm, 6"
15-4232-15Z



gezahnt
serrated
dentada
dentata



15,0 cm, 6"
15-4203-15



18,0 cm, 7"
15-4203-18

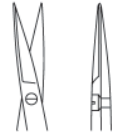

Pinzetten
Forceps
Pinzas
Pinze



Anatomische Pinzetten
 Dissecting Forceps
 Pinzas de disección
 Pinze anatomiche per dissezione



STANDARD

10,5 cm, 4 ¹ / ₈ "	16-4002-10
11,5 cm, 4 ¹ / ₂ "	16-4002-11
13,0 cm, 5"	16-4002-13
14,5 cm, 5 ³ / ₄ "	16-4002-14
15,0 cm, 6"	16-4002-15
16,0 cm, 6 ¹ / ₄ "	16-4002-16
18,0 cm, 7"	16-4002-18
20,0 cm, 8"	16-4002-20
25,0 cm, 10"	16-4002-25
30,0 cm, 12"	16-4002-30



schmal
 narrow
 estrechos
 stretti

STANDARD

10,5 cm, 4 ¹ / ₈ "	16-4003-10
11,5 cm, 4 ¹ / ₂ "	16-4003-11
13,0 cm, 5"	16-4003-13
14,5 cm, 5 ³ / ₄ "	16-4003-14
15,0 cm, 6"	16-4003-15
16,0 cm, 6 ¹ / ₄ "	16-4003-16
18,0 cm, 7"	16-4003-18
20,0 cm, 8"	16-4003-20
25,0 cm, 10"	16-4003-25
30,0 cm, 12"	16-4003-30



schmal
 narrow
 estrechos
 stretti

STANDARD

10,5 cm, 4 ¹ / ₈ "	16-4004-10
11,5 cm, 4 ¹ / ₂ "	16-4004-11
13,0 cm, 5"	16-4004-13
14,5 cm, 5 ³ / ₄ "	16-4004-14
15,0 cm, 6"	16-4004-15
16,0 cm, 6 ¹ / ₄ "	16-4004-16
18,0 cm, 7"	16-4004-18
20,0 cm, 8"	16-4004-20
25,0 cm, 10"	16-4004-25
30,0 cm, 12"	16-4004-30



fein
 fine
 finas
 fini

STANDARD

10,5 cm, 4 ¹ / ₈ "	16-4010-10
11,5 cm, 4 ¹ / ₂ "	16-4010-11
13,0 cm, 5"	16-4010-13
14,5 cm, 5 ³ / ₄ "	16-4010-14
15,0 cm, 6"	16-4010-15
16,0 cm, 6 ¹ / ₄ "	16-4010-16
18,0 cm, 7"	16-4010-18
20,0 cm, 8"	16-4010-20
25,0 cm, 10"	16-4010-25
30,0 cm, 12"	16-4010-30

Anatomische Pinzetten
 Dissecting Forceps
 Pinzas de disección
 Pinze anatomiche per dissezione



fein
 fine
 finas
 fini



fein
 fine
 finas
 fini

mit Stift
 with pin
 con perno
 con espiga



MOD. USA

12,0 cm, 4 ³ / ₄ "	16-4006-10
13,0 cm, 5"	16-4006-13
14,5 cm, 5 ³ / ₄ "	16-4006-14
15,0 cm, 6"	16-4006-15
18,0 cm, 7"	16-4006-18
20,0 cm, 8"	16-4006-20
25,5 cm, 10"	16-4006-25
30,0 cm, 12"	16-4006-30



schmal
 narrow
 estrechos
 stretti

MOD. USA

12,0 cm, 4 ³ / ₄ "	16-4012-11
13,0 cm, 5"	16-4012-13
14,5 cm, 5 ³ / ₄ "	16-4012-14
15,0 cm, 6"	16-4012-15
18,0 cm, 7"	16-4012-18
20,0 cm, 8"	16-4012-20
25,5 cm, 10"	16-4012-25

10,5 cm, 4 ¹ / ₈ "	16-4011-10
11,5 cm, 4 ¹ / ₂ "	16-4011-11
13,0 cm, 5"	16-4011-13
14,5 cm, 5 ³ / ₄ "	16-4011-14
16,0 cm, 6 ¹ / ₄ "	16-4011-16
18,0 cm, 7"	16-4011-18
20,0 cm, 8"	16-4011-20
25,0 cm, 10"	16-4011-25
30,0 cm, 12"	16-4011-30

10,5 cm, 4 ¹ / ₈ "	16-4018-10
11,5 cm, 4 ¹ / ₂ "	16-4018-11
13,0 cm, 5"	16-4018-13
14,5 cm, 5 ³ / ₄ "	16-4018-14
16,0 cm, 6 ¹ / ₄ "	16-4018-16
18,0 cm, 7"	16-4018-18
20,0 cm, 8"	16-4018-20
25,0 cm, 10"	16-4018-25
30,0 cm, 12"	16-4018-30

Anatomische Pinzetten
Dissecting Forceps
Pinzas de disección
Pinze anatomiche per dissezione



ADSON
 12,0 cm, 4³/₄" **16-4070-12**
 15,0 cm, 6" **16-4070-15**



MICRO-ADSON
 12,0 cm, 4³/₄" **16-4076-12**
 15,0 cm, 6" **16-4076-15**



STILLE
 15,0 cm, 6"
16-4008-15



MC INDOE
 15,0 cm, 6"
16-4158-15



TAYLOR
 17,5 cm, 6⁵/₈"
16-4114-17



TAYLOR
 17,5 cm, 6⁵/₈"
16-4115-17



TAYLOR
 18,5 cm, 7¹/₄"
16-4117-18



GERALD
 18,0 cm, 7"
16-4102-18

Anatomische Pinzetten
 Dissecting Forceps
 Pinzas de disección
 Pinze anatomiche per dissezione



GERALD
 18,0 cm, 7"
16-4103-18



POTTS-SMITH
 18,0 cm, 7" **16-4026-18**
 21,0 cm, 8¹/₄" **16-4026-21**
 25,0 cm, 10" **16-4026-25**



POTTS-SMITH
 18,0 cm, 7" **16-4027-18**
 21,0 cm, 8¹/₄" **16-4027-21**
 25,0 cm, 10" **16-4027-25**



englische Modelle
 english patterns
 modelos ingleses
 modelli inglese

13,0 cm, 5" **16-4036-13**
 14,5 cm, 5³/₄" **16-4036-14**
 15,0 cm, 6" **16-4036-15**



SEMKEN
 12,5 cm, 5" **16-4040-12**
 15,0 cm, 6" **16-4040-15**



CUSHING
 17,5 cm, 6⁵/₈"
16-4092-17



CUSHING
 17,5 cm, 6⁵/₈"
16-4093-17



BROPHY
 20,0 cm, 8"
16-4094-20

Anatomische Pinzetten
Dissecting Forceps
Pinzas de disección
Pinze anatomiche per dissezione



BROPHY
 20,0 cm, 8"
 16-4095-20



BONNEY
 18,0 cm, 7"
 16-4120-18



SINGLE-TUTTLE
 23,0 cm, 9"
 16-4516-23



DENNIS BROWN
 20,0 cm, 8"
 16-4126-20



DUEHRSEN
 20,0 cm, 8"
 16-4470-20



WAUGH
 15,0 cm, 6" **16-4130-15**
 20,0 cm, 8" **16-4130-20**



RAMSEY
 18,0 cm, 7"
 16-4136-18



STANDARD

10,5 cm, 4 ¹ / ₈ "	16-4200-10
11,5 cm, 4 ¹ / ₂ "	16-4200-11
13,0 cm, 5"	16-4200-13
14,5 cm, 5 ³ / ₄ "	16-4200-14
15,0 cm, 6"	16-4200-15
16,0 cm, 6 ¹ / ₄ "	16-4200-16
18,0 cm, 7"	16-4200-18
20,0 cm, 8"	16-4200-20
25,0 cm, 10"	16-4200-25
30,0 cm, 12"	16-4200-30

11,5 cm, 4 ¹ / ₂ "	16-4252-11
13,0 cm, 5"	16-4252-13
14,5 cm, 5 ³ / ₄ "	16-4252-14
16,0 cm, 6 ¹ / ₄ "	16-4252-16
18,0 cm, 7"	16-4252-18
20,0 cm, 8"	16-4252-20
25,0 cm, 10"	16-4252-25
30,0 cm, 12"	16-4252-30

13,0 cm, 5"	16-4254-13
14,5 cm, 5 ³ / ₄ "	16-4254-14
16,0 cm, 6 ¹ / ₄ "	16-4254-16
18,0 cm, 7"	16-4254-18
20,0 cm, 8"	16-4254-20

13,0 cm, 5"	16-4256-13
14,5 cm, 5 ³ / ₄ "	16-4256-14
16,0 cm, 6 ¹ / ₄ "	16-4256-16
18,0 cm, 7"	16-4256-18
20,0 cm, 8"	16-4256-20

Chirurgische Pinzetten
Tissue Forceps
Pinzas quirúrgicas
Pinze per chirurgia



13,0 cm, 5"	16-4210-13
14,5 cm, 5 ³ / ₄ "	16-4210-14
15,5 cm, 6"	16-4210-15
16,0 cm, 6 ¹ / ₄ "	16-4210-16
18,0 cm, 7"	16-4210-18
20,0 cm, 8"	16-4210-20
25,0 cm, 10"	16-4210-25
30,0 cm, 12"	16-4210-30



13,0 cm, 5"	16-4218-13
14,5 cm, 5 ³ / ₄ "	16-4218-14
15,5 cm, 6"	16-4218-15
16,0 cm, 6 ¹ / ₄ "	16-4218-16
18,0 cm, 7"	16-4218-18
20,0 cm, 8"	16-4218-20
25,0 cm, 10"	16-4218-25
30,0 cm, 12"	16-4218-30



13,0 cm, 5"	16-4219-13
14,5 cm, 5 ³ / ₄ "	16-4219-14
16,0 cm, 6 ¹ / ₄ "	16-4219-16
18,0 cm, 7"	16-4219-18
20,0 cm, 8"	16-4219-20



13,0 cm, 5"	16-4236-13
14,5 cm, 5 ³ / ₄ "	16-4236-14
15,0 cm, 6"	16-4236-15



MOD. USA	
12,0 cm, 4 ³ / ₄ "	16-4206-12
13,0 cm, 5"	16-4206-13
14,5 cm, 5 ³ / ₄ "	16-4206-14
15,5 cm, 6"	16-4206-15
18,0 cm, 7"	16-4206-18
20,0 cm, 8"	16-4206-20
25,0 cm, 10"	16-4206-25
30,0 cm, 12"	16-4206-30

MOD. USA	
12,0 cm, 4 ³ / ₄ "	16-4212-12
13,0 cm, 5"	16-4212-13
14,5 cm, 5 ³ / ₄ "	16-4212-14
15,5 cm, 6"	16-4212-15
18,0 cm, 7"	16-4212-18
20,0 cm, 8"	16-4212-20
25,0 cm, 10"	16-4212-25
30,0 cm, 12"	16-4212-30

ADSON	
12,0 cm, 4 ³ / ₄ "	16-4270-12
15,0 cm, 6"	16-4270-15

MICRO-ADSON	
12,0 cm, 4 ³ / ₄ "	16-4276-12
15,0 cm, 6"	16-4276-15

Chirurgische Pinzetten
 Tissue Forceps
 Pinzas quirúrgicas
 Pinze per chirurgia

 2 x 3



ADSON

12,0 cm, 4³/₄" **16-4074-12**
 15,0 cm, 6" **16-4074-15**

 7 x 7



ADSON-BROWN

12,0 cm, 4³/₄" **16-4288-12**
 15,0 cm, 6" **16-4288-15**

 1 x 2



ADSON

12,0 cm, 4³/₄"
16-4282-12

 1 x 2



STILLE

15,0 cm, 6"
16-4208-15

 2 x 3



STILLE

15,0 cm, 6"
16-4209-15

 1 x 2



GILLIES

15,0 cm, 6"
16-4300-15

 2 x 3



ADLERKREUTZ

15,0 cm, 6" **16-4382-15**
 20,0 cm, 8" **16-4382-20**

 4 x 5



ADLERKREUTZ

15,0 cm, 6" **16-4384-15**
 20,0 cm, 8" **16-4384-20**

Chirurgische Pinzetten
Tissue Forceps
Pinzas quirúrgicas
Pinze per chirurgia



SEMKEN
12,5 cm, 5" **16-4240-12**
15,5 cm, 6" **16-4240-15**



SEMKEN
12,5 cm, 5" **16-4242-12**



MC INDOE
15,0 cm, 6" **16-4358-15**



TAYLOR
17,5 cm, 6⁵/₈" **16-4314-17**



TAYLOR
17,5 cm, 6⁵/₈" **16-4315-17**



TAYLOR
17,5 cm, 6⁵/₈" **16-4317-17**



GERALD
18,0 cm, 7" **16-4302-18**



GERALD
18,0 cm, 7" **16-4303-18**

Chirurgische Pinzetten
Tissue Forceps
Pinzas quirúrgicas
Pinze per chirurgia



CUSHING
17,5 cm, 6⁵/₈"
16-4292-17



CUSHING
17,5 cm, 6⁵/₈"
16-4293-17



POTTS-SMITH
18,0 cm, 7" 16-4226-18
21,0 cm, 8¹/₄" 16-4226-21
25,0 cm, 10" 16-4226-25



POTTS-SMITH
18,0 cm, 7" 16-4227-18
21,0 cm, 8¹/₄" 16-4227-21
25,0 cm, 10" 16-4227-25



WAUGH
15,0 cm, 6" 16-4330-15
20,0 cm, 8" 16-4330-20



BROPHY
20,0 cm, 8" 16-4294-20



BROPHY
20,0 cm, 8" 16-4295-20



RUSS. MODELL
15,0 cm, 6" 16-4456-15
20,0 cm, 8" 16-4456-20
25,0 cm, 10" 16-4456-25

Chirurgische Pinzetten
Tissue Forceps
Pinzas quirúrgicas
Pinze per chirurgia



DURANTE
14,5 cm, 5³/₄" **16-4460-14**
16,0 cm, 6¹/₄" **16-4460-16**
20,0 cm, 8" **16-4460-20**



DUEHRSSSEN
20,0 cm, 8"

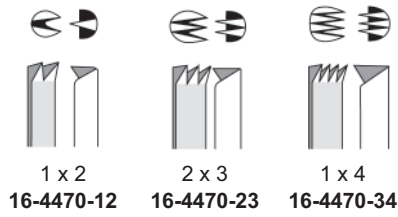

NELSON
15,0 cm, 6" **16-4518-15**
20,0 cm, 8" **16-4518-20**
23,0 cm, 9" **16-4518-23**



Fig. 1 **16-4586-14** Fig. 2 **16-4587-14**

DUVAL
14,0 cm, 5¹/₂"

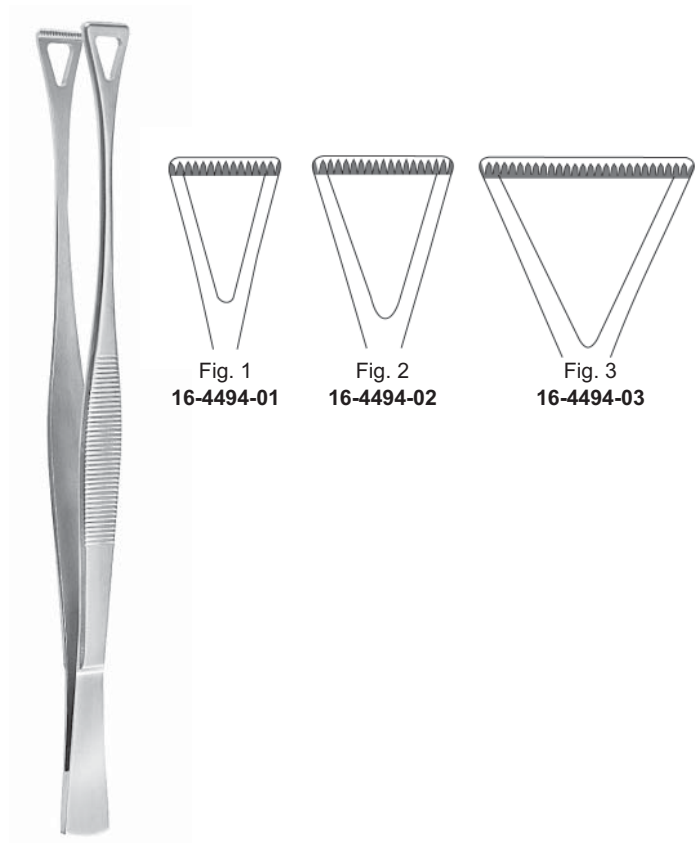

Fig. 1 **16-4494-01** Fig. 2 **16-4494-02** Fig. 3 **16-4494-03**

COLLIN-DUVAL
20,0 cm, 8"

Chirurgische Pinzetten
 Tissue Forceps
 Pinzas quirúrgicas
 Pinze per chirurgia



LANE
 14,5 cm, 5³/₄" **16-4420-14**
 20,0 cm, 8" **16-4420-20**



LANE
 14,5 cm, 5³/₄" **16-4422-14**
 20,0 cm, 8" **16-4422-20**



BROWN
 15,0 cm, 6" **16-4410-15**
 20,0 cm, 8" **16-4410-20**
 25,0 cm, 10" **16-4410-25**



TREVES
 13,0 cm, 5" **16-4510-13**
 15,0 cm, 6" **16-4510-15**

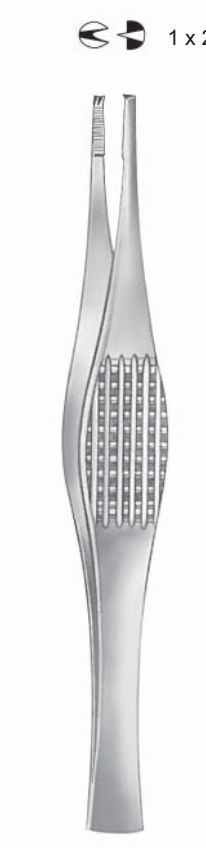

RAMSEY
 18,0 cm, 7" **16-4520-18**

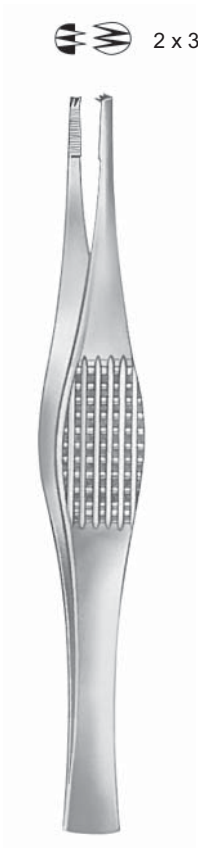

RAMSEY
 18,0 cm, 7" **16-4522-18**



RAMSEY
 18,0 cm, 7" **16-4590-18**



RAMSEY
 18,0 cm, 7" **16-4592-18**

**Splitterpinzetten
Splinter Forceps
Pinzas para espinas
Pinze per schegge**

1 x 2



8,0 cm, 3¹/₄" **16-4662-08**
 9,0 cm, 3¹/₂" **16-4662-09**
 10,5 cm, 4¹/₈" **16-4662-10**
 11,5 cm, 4¹/₂" **16-4662-11**
 13,0 cm, 5" **16-4662-13**
 14,5 cm, 5¹/₂" **16-4662-14**



8,0 cm, 3¹/₄" **16-4663-08**
 9,0 cm, 3¹/₂" **16-4663-09**
 10,5 cm, 4¹/₈" **16-4663-10**
 11,5 cm, 4¹/₂" **16-4663-11**
 13,0 cm, 5" **16-4663-13**
 14,5 cm, 5¹/₂" **16-4663-14**



8,0 cm, 3¹/₄" **16-4666-08**
 9,0 cm, 3¹/₂" **16-4666-09**
 10,5 cm, 4¹/₈" **16-4666-10**
 11,5 cm, 4¹/₂" **16-4666-11**
 13,0 cm, 5" **16-4666-13**
 14,5 cm, 5¹/₂" **16-4666-14**



8,0 cm, 3¹/₄" **16-4667-08**
 9,0 cm, 3¹/₂" **16-4667-09**
 10,5 cm, 4¹/₈" **16-4667-10**
 11,5 cm, 4¹/₂" **16-4667-11**
 13,0 cm, 5" **16-4667-13**
 14,5 cm, 5¹/₂" **16-4667-14**

Splitterpinzetten, Mikro-Pinzetten
Splinter Forceps, Micro Forceps
Pinzas para espinas, Pinzas para microscopia
Pinze per schegge, Pinze per microscopia



HUNTER
 10,5 cm, 4¹/₄"
16-4652-10



HUNTER
 10,5 cm, 4¹/₄"
16-4653-10



WALTER-CARMALT
 10,5 cm, 4¹/₄"
16-4656-10



WALTER-CARMALT
 10,5 cm, 4¹/₄"
16-4657-10



FEILCHENFELD
 7,5 cm, 3¹/₈" **16-4650-07**
 9,0 cm, 3¹/₂" **16-4650-09**
 11,5 cm, 4¹/₂" **16-4650-11**



10,0 cm, 4"
16-4806-10



10,0 cm, 4"
16-4807-10



10,0 cm, 4"
16-4809-10

Mikro-Pinzetten
Micro Forceps
Pinzas para microscopia
Pinze per microscopia



GRAEFE
10,0 cm, 4"
16-4810-10



GRAEFE
10,0 cm, 4"
16-4811-10



GRAEFE
10,0 cm, 4"
16-4813-10



GRAEFE
10,0 cm, 4"
16-4814-10



GRAEFE
10,0 cm, 4"
16-4815-10



GRAEFE
10,0 cm, 4"
16-4817-10

Uhrmacher Pinzetten, Gefäßdilatoren
 Jeweller's Forceps, Vessel Dilators
 Pinzas de relojería, Dilatadores vasculares
 Pinze per orologiaio, Dilatatori vascolari



Fig. 3
 11,5 cm, 4 1/2"
 16-4601-03

0,3 mm x 45°



Fig. 4
 11,5 cm, 4 1/2"
 16-4601-04

0,3 mm x 90°



Fig. 5
 11,5 cm, 4 1/2"
 16-4601-05

0,3 mm



Fig. 7
 11,5 cm, 4 1/2"
 16-4601-07

0,3 mm x 45°



9 mm

11,0 cm, 4 3/8"
 16-4620-01



9 mm

11,0 cm, 4 3/8"
 16-4620-02



9 mm

11,0 cm, 4 3/8"
 16-4620-03



9 mm

11,0 cm, 4 3/8"
 16-4620-04

diamantbeschichtet
 diamond coated
 diamantato
 diamantato

Gefäßdilatoren, Atraumatische Pinzetten
 Vessel Dilators, Atraumatic Forceps
 Dilatadores vasculares, Pinzas atraumáticas
 Dilatatori vascolari, Pinze anatomiche atraumatica

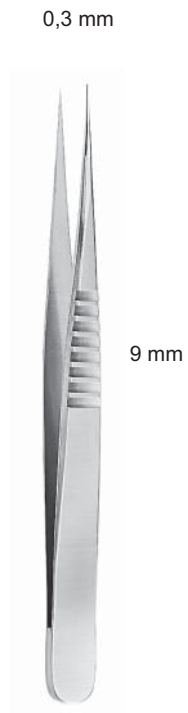

12,0 cm, 4³/₄"
16-4634-12



13,5 cm, 5³/₈"
16-4634-13



13,5 cm, 5³/₈"
16-4635-13

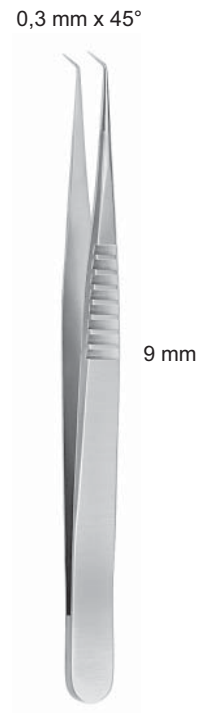

13,5 cm, 5³/₈"
16-4637-13



	1,5 mm	2,0 mm	2,4 mm	2,8 mm
16,0 cm, 6 ¹ / ₄ "	16-4700-16	16-4702-16	16-4704-16	16-4706-16
20,0 cm, 8"	16-4700-20	16-4702-20	16-4704-20	16-4706-20
24,0 cm, 9 ¹ / ₂ "	16-4700-24	16-4702-24	16-4704-24	16-4706-24
30,0 cm, 12"	16-4700-30	16-4702-30	16-4704-30	16-4706-30

	2,8 mm	3,5 mm	3,5 mm
16,0 cm, 6 ¹ / ₄ "	16-4716-16	16-4708-16	16-4718-16
20,0 cm, 8"	16-4716-20	16-4708-20	16-4718-20
24,0 cm, 9 ¹ / ₂ "	16-4716-24	16-4708-24	16-4718-24
30,0 cm, 12"	16-4716-30	16-4708-30	16-4718-30

DE BAKEY



	1,5 mm	2,0 mm
16,0 cm, 6 ¹ / ₄ "	16-4701-16	16-4703-16
20,0 cm, 8"	16-4701-20	16-4703-20
24,0 cm, 9 ¹ / ₂ "	16-4701-24	16-4703-24
30,0 cm, 12"	16-4701-30	16-4703-30

DE BAKEY

Pinzetten mit Hartmetalleinlagen
 Forceps with tungsten carbide inserts
 Pinzas con bocas de carburo tungsteno
 Pinze con morsi in carburo di tungsteno



STANDARD	
14,5 cm, 5 ³ / ₄ "	17-4200-14
16,0 cm, 6 ¹ / ₄ "	17-4200-16
18,0 cm, 7"	17-4200-18
20,0 cm, 8"	17-4200-20
25,0 cm, 10"	17-4200-25
30,0 cm, 12"	17-4200-30

STANDARD	
14,0 cm, 5 ¹ / ₂ "	17-4208-14
16,0 cm, 6 ¹ / ₄ "	17-4208-16
18,0 cm, 7"	17-4208-18
20,0 cm, 8"	17-4208-20
25,0 cm, 10"	17-4208-25
30,0 cm, 12"	17-4208-30

STANDARD	
12,5 cm, 5"	17-4040-12
15,0 cm, 6"	17-4040-15

STANDARD	
15,0 cm, 6"	17-4140-15
23,0 cm, 9"	17-4140-23
25,0 cm, 10"	17-4140-25

Pinzetten mit Hartmetalleinlagen
Forceps with tungsten carbide inserts
Pinzas con bocas de carburo tungsteno
Pinze con morsi in carburo di tungsteno



GILLIES
 15,0 cm, 6"
 17-4300-15



MC INDOE
 15,0 cm, 6"
 17-4158-15



17-4102-17



17-4302-17

GERALD
 17,0 cm, 6³/₄"

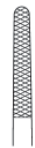

POTTS-SMITH
 15,0 cm, 6" **17-4026-15**
 18,0 cm, 7" **17-4026-18**
 20,0 cm, 8" **17-4026-20**



BONNEY
 17,5 cm, 6⁵/₈"
 17-4590-17

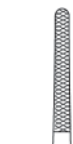

17-4092-17

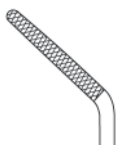

17-4093-17

CUSHING
 17,5 cm, 6⁵/₈"



CUSHING-TAYLOR
 18,0 cm, 7"
 17-4117-18

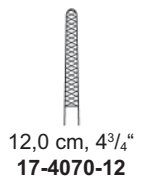

12,0 cm, 4³/₄"
17-4070-12

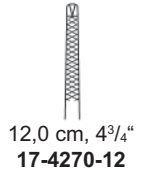

12,0 cm, 4³/₄"
17-4270-12

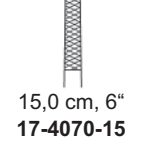

15,0 cm, 6"
17-4070-15

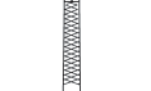

15,0 cm, 6"
17-4270-15

ADSON
 17,5 cm, 6⁵/₈"

Tuch-, Schlauchklemmen, Tupferzangen

Towel Clamps, Sponge and Dressing Forceps, Tubing Clamps

Pinzas de campo, Pinzas para vendajes y torundas y para tubos

Pinze per fissare le compresse, per medicatura e tamponi, e per tubi



Tuchklemmen
Towel Clamps
Pinzas de campo
Pinze per fissare le compresse



SCHAEDEL
9,0 cm, 3 1/2"
22-4101-09



ENGL. MODELL
9,0 cm, 3 1/2"
22-4109-09



JONES
5,0 cm, 2" 22-4105-05
7,0 cm, 2 3/4" 22-4105-07
9,0 cm, 3 1/2" 22-4105-09



JONES
9,0 cm, 3 1/2"
22-4107-09

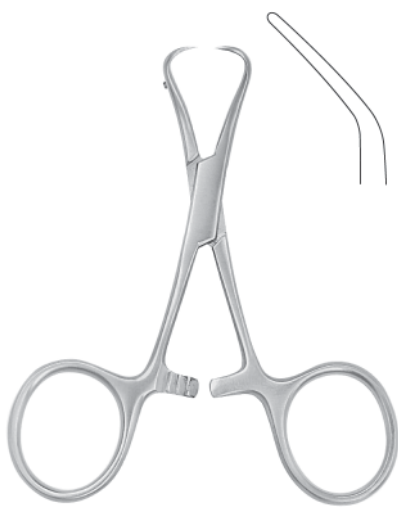

BACKHAUS
9,0 cm, 3 1/2" 22-4000-09
11,0 cm, 4 3/8" 22-4000-11
13,0 cm, 5" 22-4000-13
15,0 cm, 6" 22-4000-15



mit Schlauch- oder Kabelhalter
with clip for tubing or cable
con porta-tubo o porta-cable
con porta-tubo o porta-cavo

11,0 cm, 4 3/8"
22-4005-11



ROEDER
13,0 cm, 5"
22-4010-13

**Tuchklemmen
Towel Clamps
Pinzas de campo
Pinze per fissare le compresse**



ROEDER
15,0 cm, 5"
22-4010-15



BERNHARD
16,5 cm, 6 1/2"
22-4044-16



Kugel / Pfanne
Ball / Socket
Bola / Cojinete
Palla / Cuscinetto

13,0 cm, 5"
22-4024-13

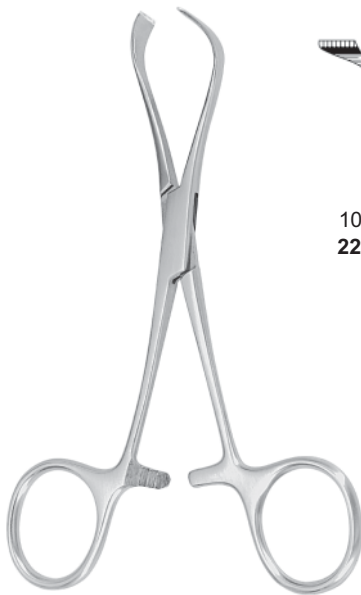
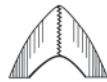

LORNA



10,0 cm, 4"
22-4014-10

13,0 cm, 5"
22-4014-13



LANE
15,0 cm, 6" 22-4040-15
18,0 cm, 7" 22-4040-18
20,0 cm, 8" 22-4040-20

Tuchklemmen, Korn- und Tupferzangen
 Towel Clamps, Sponge and Dressing Forceps
 Pinzas de campo, Pinzas para vendajes y torundas
 Pinze per fissare le compresse, Pinze per medicatura e tamponi



TOHOKU



10,0 cm, 4"
 22-4020-10



13,0 cm, 5"
 22-4020-13



PEERS
 14,5 cm, 5³/₄"
 22-4030-14



LISTER
 13,0 cm, 5" 22-4360-13
 16,0 cm, 6¹/₄" 22-4360-16
 18,0 cm, 7" 22-4360-18



BRYANT
 13,0 cm, 5"
 22-4351-13



BOZEMANN
 26,0 cm, 10¹/₄"
 22-4320-26

Korn- und Tupferzangen
Sponge and Dressing Forceps
Pinzas para vendajes y torundas
Pinze per medicatura e tamponi

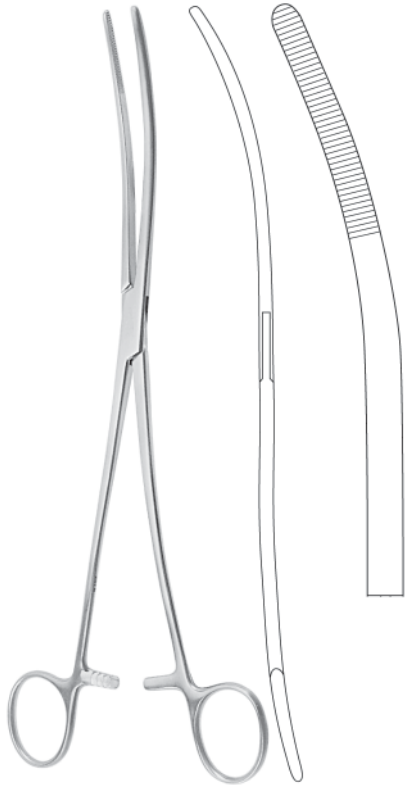

BOZEMANN
 26,0 cm, 10¹/₄"
 22-4321-26



COLLIN
 25,0 cm, 9³/₄"
 22-4300-25



CHERON
 25,0 cm, 9³/₄"
 22-4303-25



PELKMANN
 25,0 cm, 9³/₄"

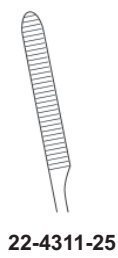

ULRICH

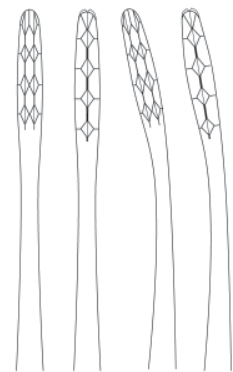

22,0 cm, 8⁵/₈" 22-4200-22 22-4201-22
 25,0 cm, 9³/₄" 22-4200-25 22-4201-25
 27,0 cm, 10⁵/₈" 22-4200-27 22-4201-27

Korn- und Tupferzangen
Sponge and Dressing Forceps
Pinzas para vendajes y torundas
Pinze per medicatura e tamponi

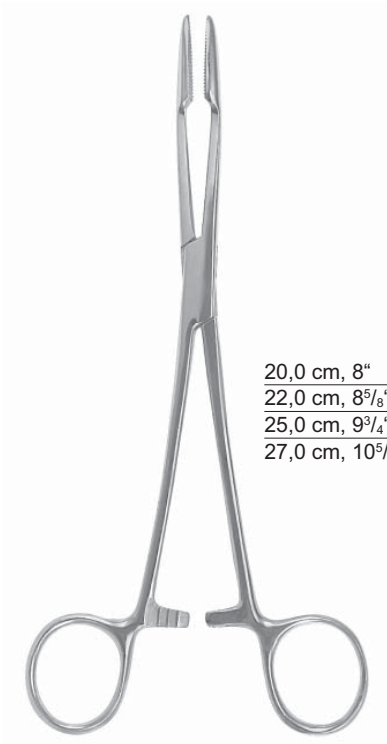

20,0 cm, 8"	22-4210-20	22-4211-20
22,0 cm, 8 ⁵ / ₈ "	22-4210-22	22-4211-22
25,0 cm, 9 ³ / ₄ "	22-4210-25	22-4211-25
27,0 cm, 10 ⁵ / ₈ "	22-4210-27	22-4211-27

GROSS-MAIER



25,0 cm, 9³/₄"
22-4180-25

25,0 cm, 9³/₄"
22-4181-25

FOERSTER



18,0 cm, 7"	22-4160-18	22-4161-18	22-4170-18	22-4171-18
20,0 cm, 8"	22-4160-20	22-4161-20	22-4170-20	22-4171-20
25,0 cm, 9 ³ / ₄ "	22-4160-25	22-4161-25	22-4170-25	22-4171-25

FOERSTER-BALLENGER



RAMPLEY
 18,0 cm, 7" **22-4190-18**
 25,0 cm, 9³/₄" **22-4190-25**

Schlauchklemmen
Tubing Clamps
Pinzas para tubos
Pinze per tubi



PRESBYTERIAN

16,5 cm, 6 ¹ / ₂ "	23-4012-16
18,0 cm, 7"	23-4012-18
20,0 cm, 8"	23-4012-20

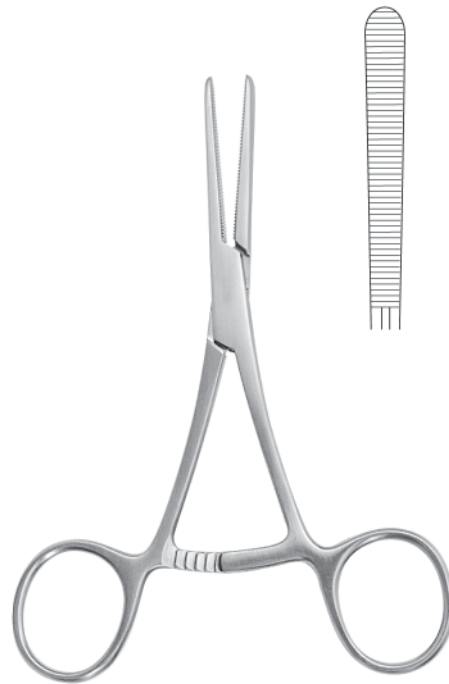

BERLIN

14,5 cm, 5³/₄"
23-4006-14

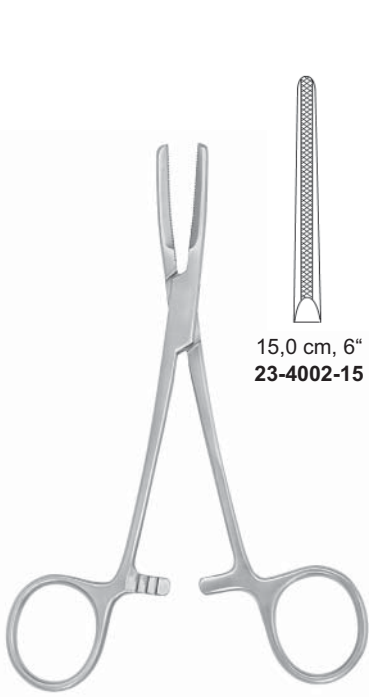

15,0 cm, 6"
23-4002-15

18,0 cm, 7"
23-4002-18

20,0 cm, 8"
23-4002-20

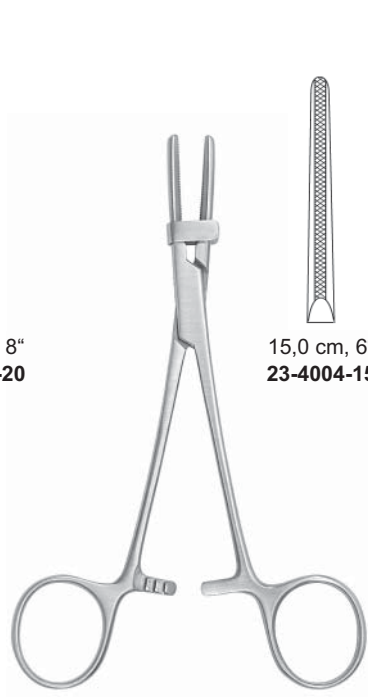

15,0 cm, 6"
23-4004-15

18,0 cm, 7"
23-4004-18

20,0 cm, 8"
23-4004-20

Klemmen
Forceps
Pinas
Pinze



Bulldogklemmen
Bulldog Clamps
Clamps Bulldog
Pinze Bulldog



3,5 cm, 1 1/2"	20-4014-03	20-4015-03
5,0 cm, 2"	20-4014-05	20-4015-05



DIEFFENBACH

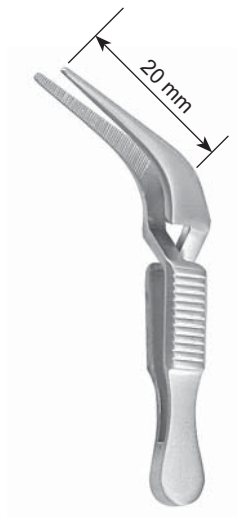

HESS
20-4520-01

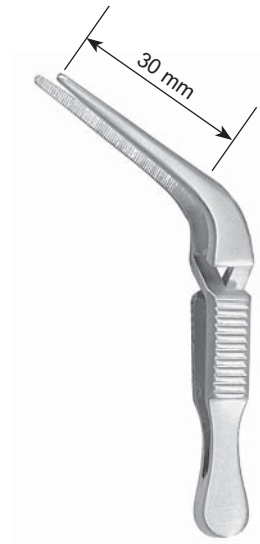

HESS
20-4520-02



3,8 cm, 1 1/2"	20-4018-04	20-4019-04
5,0 cm, 2"	20-4018-05	20-4019-05
6,3 cm, 2 1/2"	20-4018-06	20-4019-06
7,6 cm, 3"	20-4018-07	20-4019-07
9,0 cm, 3 1/2"	20-4018-09	20-4019-09

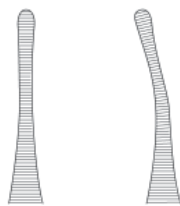

JOHNS-HOPKINS



JOHNS-HOPKINS
23,0 cm, 9"
20-4295-23



mit atraumatischer Riefung
 with non-traumatic serration
 con bocas atraumáticas
 con presa atraumatica

		L
7,5 cm, 3"	20-4292-07	2,5 cm, 1"
8,5 cm, 3 ¹ / ₄ "	20-4292-08	3,5 cm, 1 ³ / ₈ "
10,5 cm, 4 ¹ / ₈ "	20-4292-10	5,0 cm, 2"
12,0 cm, 4 ³ / ₄ "	20-4292-12	6,8 cm, 2 ³ / ₄ "

DE BAKEY

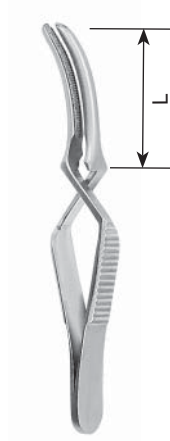

mit atraumatischer Riefung
 with non-traumatic serration
 con bocas atraumáticas
 con presa atraumatica

		L
7,0 cm, 2 ³ / ₄ "	20-4293-07	2,5 cm, 1"
8,0 cm, 3 ¹ / ₈ "	20-4293-08	3,5 cm, 1 ³ / ₈ "
10,0 cm, 3 ³ / ₄ "	20-4293-10	5,0 cm, 2"
11,5 cm, 4 ¹ / ₂ "	20-4293-12	6,8 cm, 2 ³ / ₄ "

DE BAKEY



TITANIUM
 3,5 cm, 1³/₈"
 vena **21-4032-35**
 arteria **21-4042-35**



TITANIUM
 3,5 cm, 1³/₈"
 vena **21-4033-35**
 arteria **21-4043-35**



TITANIUM
 4,0 cm, 1⁵/₈"
 vena **21-4032-40**
 arteria **21-4042-40**



TITANIUM
 4,0 cm, 1⁵/₈"
 vena **21-4033-40**
 arteria **21-4043-40**

Bulldogklemmen, Darm- und Gewebefaßzangen
Bulldog Clamps, Intestinal and Tissue Grasping Forceps
Clamps Bulldog, Pinzas intestinales y para tejidos
Pinze Bulldog, Pinze da presa per intestino e tessuti

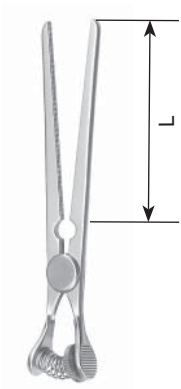

		L	
6,8 cm, 2 ³ / ₄ "	20-4298-07	3,3 cm, 1 ³ / ₈ "	
9,6 cm, 3 ³ / ₄ "	20-4298-09	5,0 cm, 2"	
11,7 cm, 4 ³ / ₄ "	20-4298-11	6,9 cm, 2 ³ / ₄ "	

GLOVER

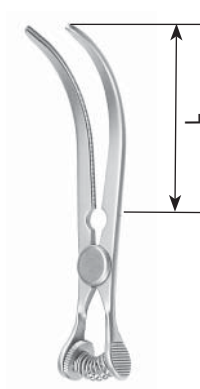

		L	
6,5 cm, 2 ¹ / ₂ "	20-4299-06	3,3 cm, 1 ³ / ₈ "	
9,1 cm, 3 ¹ / ₂ "	20-4299-09	5,0 cm, 2"	
11,0 cm, 4 ³ / ₈ "	20-4299-11	6,9 cm, 2 ³ / ₄ "	

GLOVER



CHAPUT
 13,0 cm, 5"
24-4370-13



TUFFIER
 13,0 cm, 5"
24-4372-13



COLLIN
 16,0 cm, 6¹/₄"
24-4376-16

Darm- und Gewebefaßzangen
 Intestinal and Tissue Grasping Forceps
 Pinzas intestinales y para tejidos
 Pinze da presa per intestino e tessuti



PENNINGTON

15,5 cm, 6" **24-4358-15**
 20,0 cm, 8" **24-4358-20**



ATRAUMA

25,0 cm, 9³/₄"
24-4658-25

27,0 cm, 10¹/₂"
24-4658-27

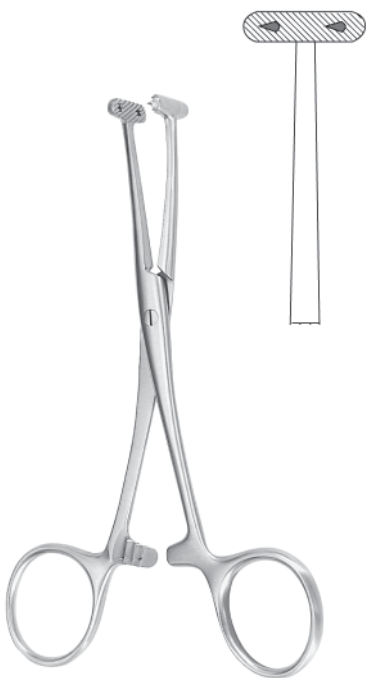

MARTEL
 14,0 cm, 5¹/₂"
24-4364-14

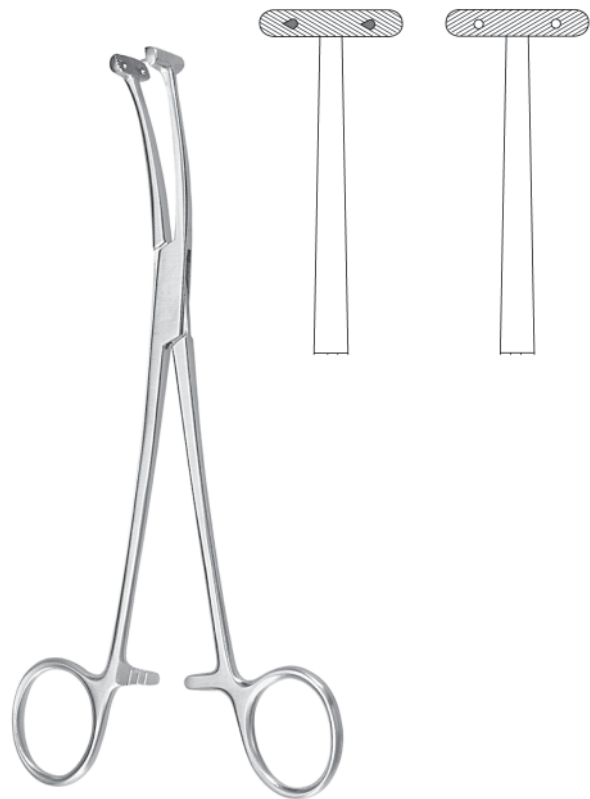

WILLET-MARTEL
 19,0 cm, 7¹/₂"
24-4366-19

Arterienklemmen
 Haemostatic Forceps
 Pinzas hemostáticas
 Pinze emostatiche



PRATT
 15,0 cm, 6"
 24-4656-15



FERGUSSON

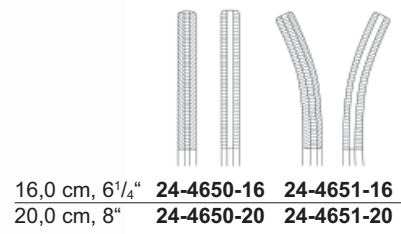

CARREL
 10,0 cm, 4"
 24-4010-10



TERRIER
 10,0 cm, 4"
 24-4016-10



KROENLEIN
 13,0 cm, 5"
 24-4369-13

Arterienklemmen
 Haemostatic Forceps
 Pinzas hemostáticas
 Pinze emostatiche



PEAN

14,0 cm, 5½" **24-4368-14**
 16,0 cm, 6¼" **24-4368-16**

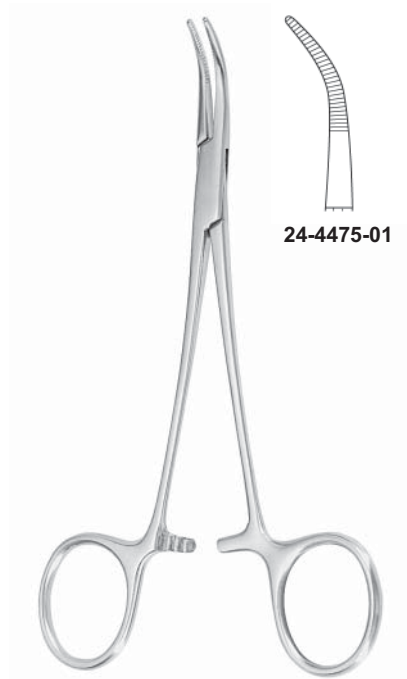

BABY-MIXTER

14,0 cm, 5½"

24-4475-01

24-4475-02



13,0 cm, 5"	24-4290-13	24-4291-13
15,0 cm, 6"	24-4290-15	24-4291-15
18,0 cm, 7"	24-4290-18	24-4291-18
20,0 cm, 8"	24-4290-20	24-4291-20

SPENCER-WELLS



HARTMANN

10,0 cm, 4"

24-4000-10

24-4001-10

Arterienklemmen
 Haemostatic Forceps
 Pinzas hemostáticas
 Pinze emostatiche

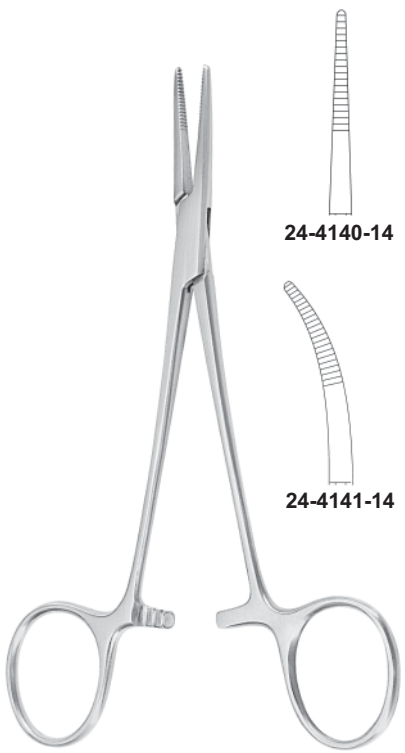

24-4140-14

24-4141-14

PROVICENCE-HOSPITAL
 14,0 cm, 5½"



HALSTED-MOSQUITO

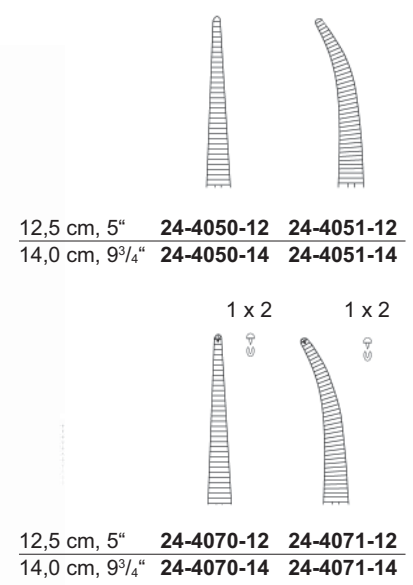

12,5 cm, 5" **24-4050-12** **24-4051-12**
 14,0 cm, 9¾" **24-4050-14** **24-4051-14**

1 x 2 1 x 2

12,5 cm, 5" **24-4070-12** **24-4071-12**
 14,0 cm, 9¾" **24-4070-14** **24-4071-14**



HALSTED-MOSQUITO

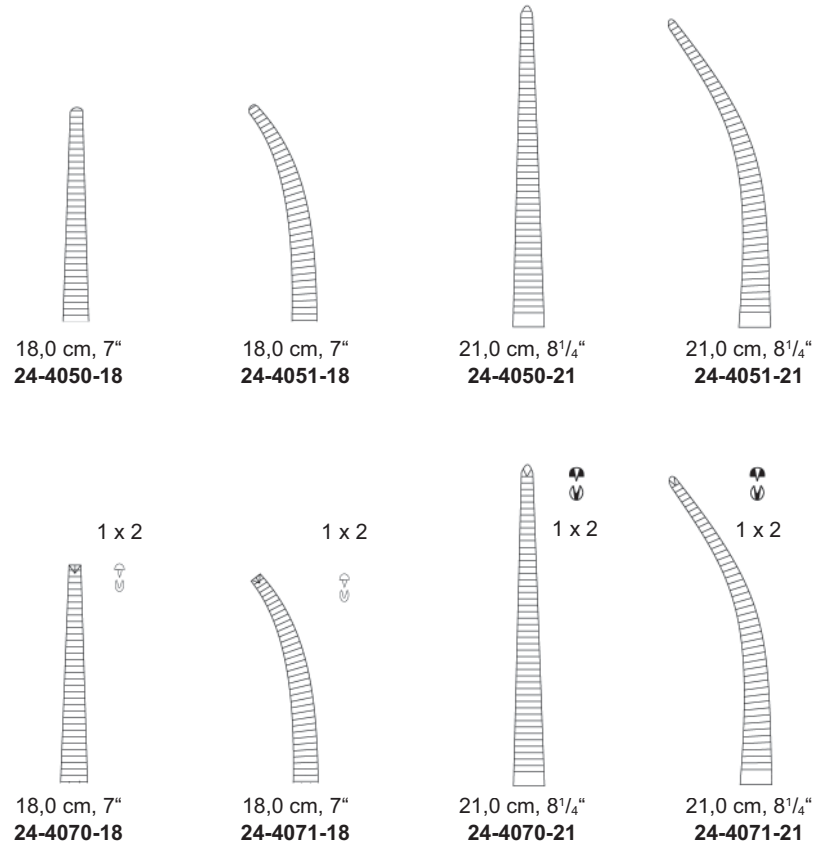

18,0 cm, 7"
24-4050-18

18,0 cm, 7"
24-4051-18

21,0 cm, 8¼"
24-4050-21

21,0 cm, 8¼"
24-4051-21

1 x 2

1 x 2

1 x 2

1 x 2

18,0 cm, 7"
24-4070-18

18,0 cm, 7"
24-4071-18

21,0 cm, 8¼"
24-4070-21

21,0 cm, 8¼"
24-4071-21

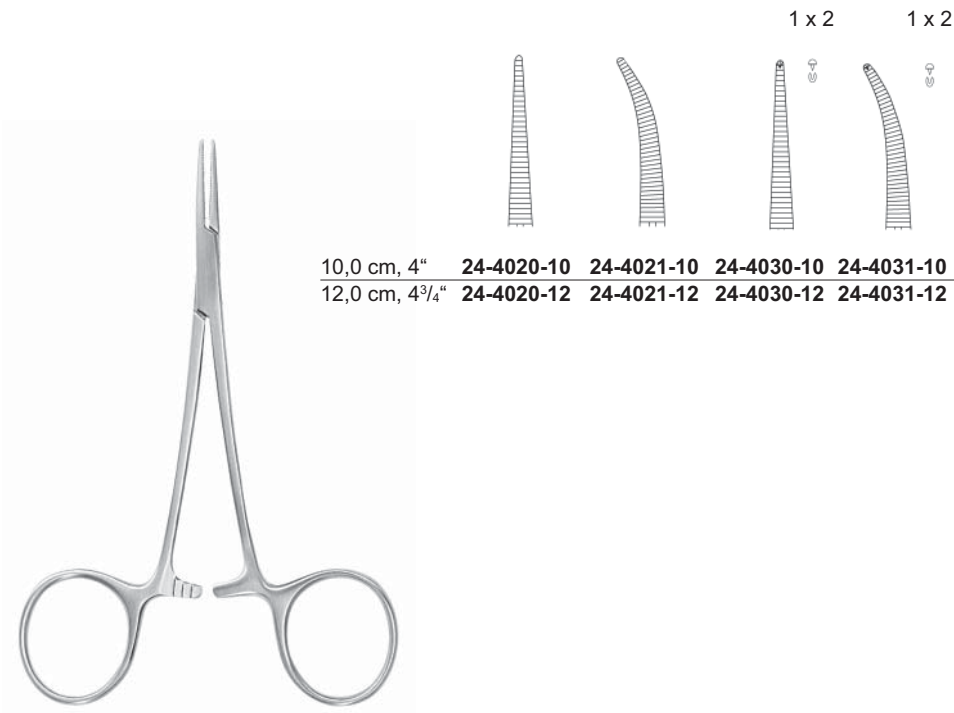

MICRO-MOSQUITO

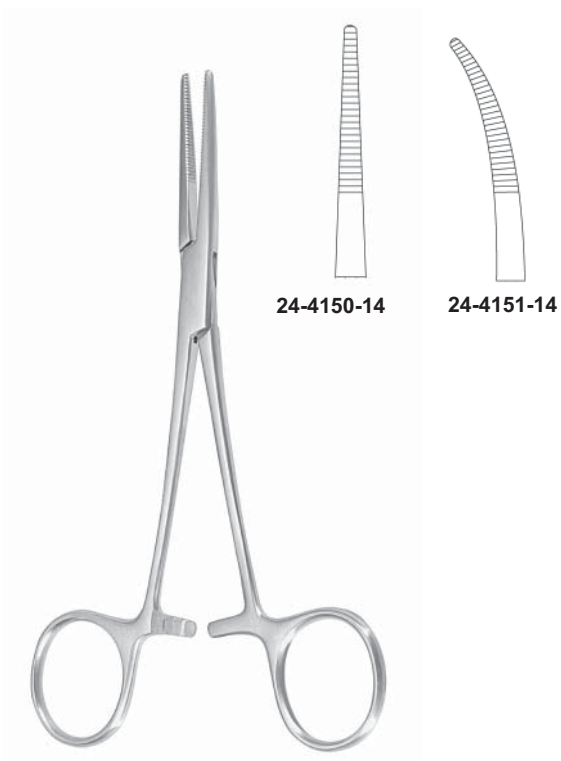

KELLY
 14,0 cm, 5¹/₂"



KELLY-RANKIN
 16,0 cm, 6¹/₄"

Arterienklemmen
 Haemostatic Forceps
 Pinzas hemostáticas
 Pinze emostatiche



LERICHE
 15,0 cm, 6"



24-4380-15



24-4381-15

1 x 2



24-4382-15

1 x 2



24-4383-15



BABY-OVERHOLT
 13,5 cm, 5 1/4"
 24-4424-14



DANDY
 14,0 cm, 5 1/2"

1 x 2



24-4347-14



CRILE
 14,0 cm, 5 1/2"



24-4160-14



24-4161-14

1 x 2



24-4170-14

1 x 2



24-4171-14

Arterienklemmen
Haemostatic Forceps
inzas hemostáticas
Pinze emostatiche



DIXON-LOVELACE
15,0 cm, 6"

24-4354-15

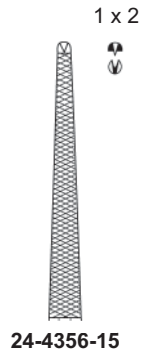

BIRKETT
19,0 cm, 7 1/2"

24-4540-19

24-4541-19



CRILE-RANKIN
16,0 cm, 6 1/4"

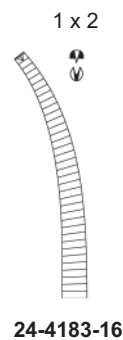
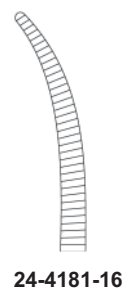
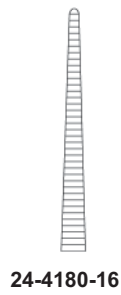

Arterienklemmen
 Haemostatic Forceps
 Pinzas hemostáticas
 Pinze emostatiche



24-4187-19

SCHNIDT
 19,0 cm, 7 1/2"



24-4185-19



24-4183-19

24-4181-19

SCHNIDT-SAWTELL
 19,0 cm, 7 1/2"



ADSON
 18,5 cm, 7 1/4"



24-4414-16



24-4415-18



44-1412-18

1 x 2



44-1413-18

1 x 2

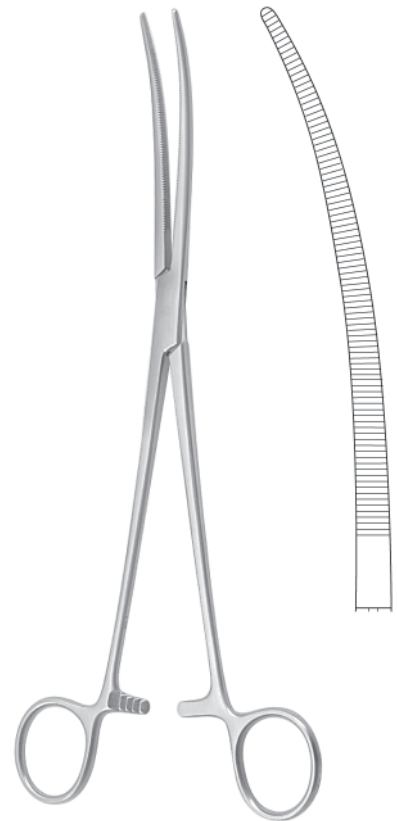

CRAFOORD
 24,0 cm, 9 1/2"
 24-4453-24

Arterienklemmen
 Haemostatic Forceps
 Pinzas hemostáticas
 Pinze emostatiche



15,0 cm, 6" **24-4480-15** **24-4481-15**
 18,5 cm, 7 1/4" **24-4480-18** **24-4481-18**

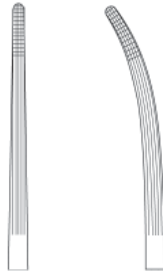

BAINBRIDGE



16,0 cm, 6 1/4" **24-4340-16** **24-4341-16**
 20,0 cm, 8" **24-4340-20** **24-4341-20**

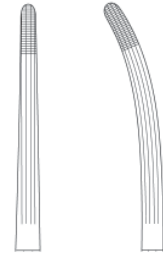

ROCHESTER-CARMALT



13,0 cm, 5" **24-4262-13** **24-4263-13**
 14,0 cm, 5 1/2" **24-4262-14** **24-4263-14**
 16,0 cm, 6 1/4" **24-4262-16** **24-4263-16**

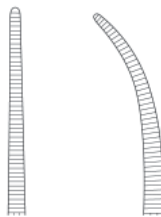

PEAN DELICATE



13,0 cm, 5" **24-4352-13** **24-4353-13**
 14,0 cm, 5 1/2" **24-4352-14** **24-4353-14**
 16,0 cm, 6 1/4" **24-4352-16** **24-4353-16**

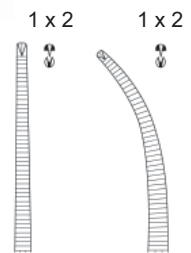

KOCHER DELICATE

Arterienklemmen
 Haemostatic Forceps
 Pinzas hemostáticas
 Pinze emostatiche



14,0 cm, 5½"	24-4260-14	24-4261-14
16,0 cm, 6¼"	24-4260-16	24-4261-16
18,0 cm, 7"	24-4260-18	24-4261-18
20,0 cm, 8"	24-4260-20	24-4261-20
22,0 cm, 8⅝"	24-4260-22	24-4261-22
24,0 cm, 9½"	24-4260-24	24-4261-24
26,0 cm, 10¼"	24-4260-26	24-4261-26
30,0 cm, 12"	24-4260-30	24-4261-30

ROCHESTER-PEAN

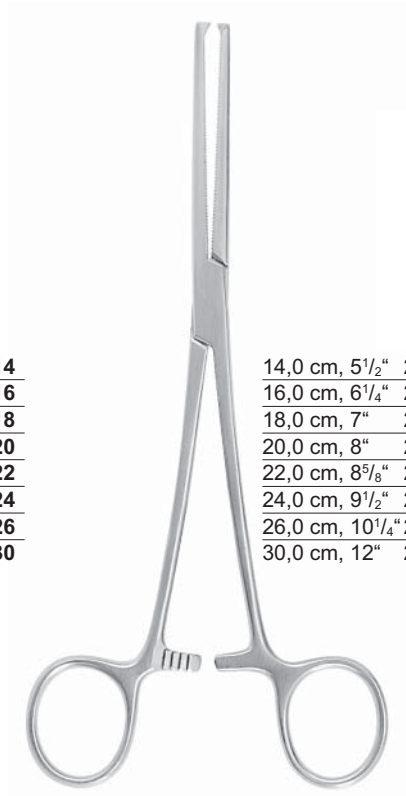

14,0 cm, 5½"	24-4350-14	24-4351-14
16,0 cm, 6¼"	24-4350-16	24-4351-16
18,0 cm, 7"	24-4350-18	24-4351-18
20,0 cm, 8"	24-4350-20	24-4351-20
22,0 cm, 8⅝"	24-4350-22	24-4351-22
24,0 cm, 9½"	24-4350-24	24-4351-24
26,0 cm, 10¼"	24-4350-26	24-4351-26
30,0 cm, 12"	24-4350-30	24-4351-30

KOCHER-OCHSNER



20,0 cm, 8"	24-4384-20	24-4385-20	24-4386-20	24-4387-20
26,0 cm, 10¼"	24-4384-26	24-4385-26	24-4386-26	24-4387-26

BENGOLEA

Arterienklemmen
Haemostatic Forceps
Pinzas hemostáticas
Pinze emostatiche



24-4390-20 24-4391-20 24-4393-20

HEISS
20,0 cm, 8"

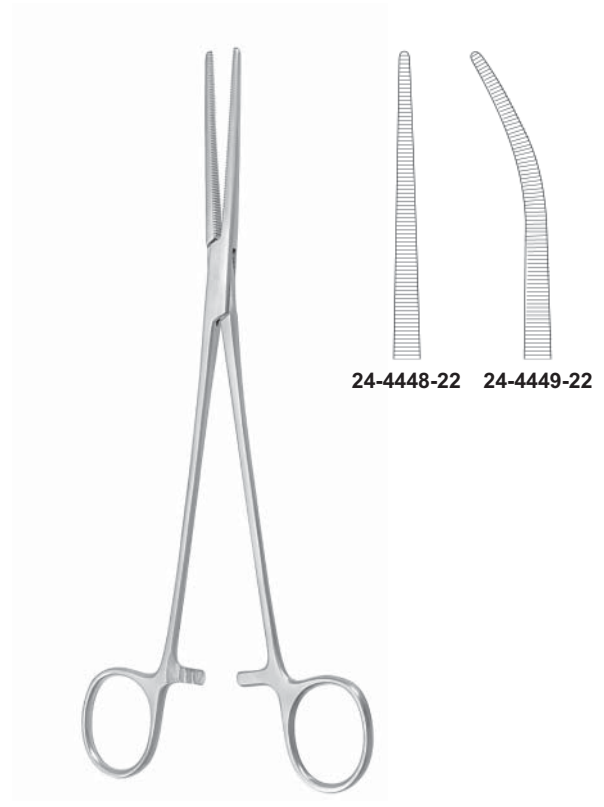

24-4448-22 24-4449-22

ROBERTS
22,0 cm, 8⁵/₈"

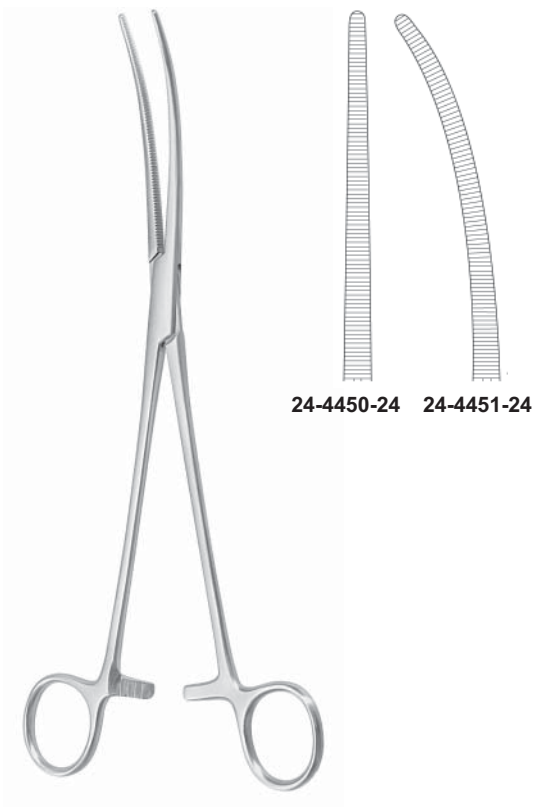

24-4450-24 24-4451-24

SAROT
24,0 cm, 9¹/₂"

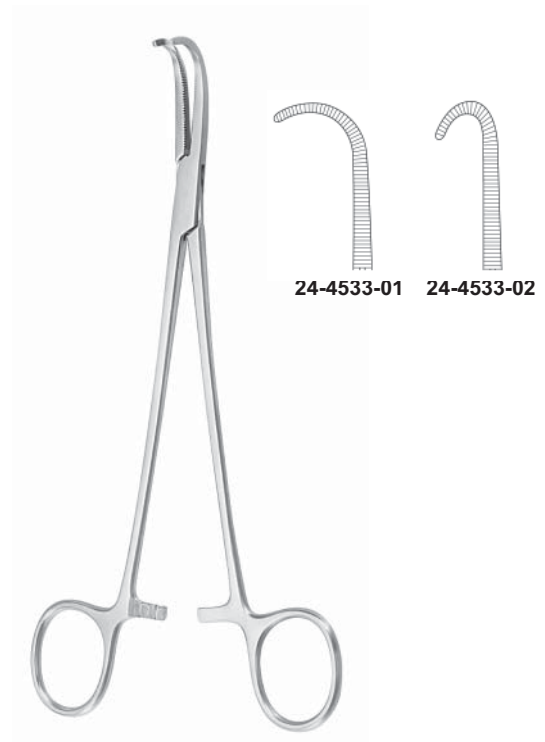

24-4533-01 24-4533-02

NEGUS
19,0 cm, 7¹/₂"

Präparier- und Ligaturklemmen
Dissecting and Ligature Forceps
Pinzas de disección y ligaduras
Pinze per preparazioni e legature



14,0 cm, 5½"
24-4411-14



18,0 cm, 7"
24-4411-18



MICRO-ADSON
 14,0 cm, 5½"
24-4409-14



BABY-MIXTER
 18,0 cm, 7"
24-4475-18



OVERHOLT-MIXTER
 21,0 cm, 8¼"
24-4471-21



JOHNS HOPKINS
 20,0 cm, 8"
24-4497-20

Präparier- und Ligaturklemmen
 Dissecting and Ligature Forceps
 Pinzas de disección y ligaduras
 Pinze per preparazioni e legature



OVERHOLT

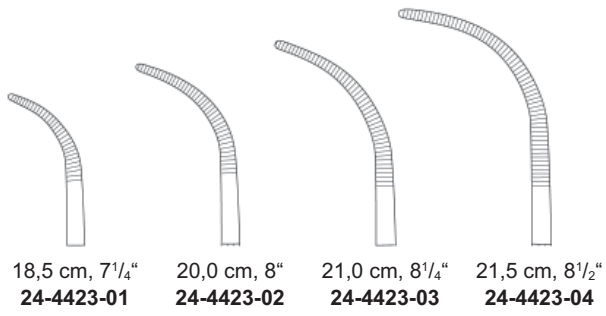

RUMEL
 23,0 cm, 9"

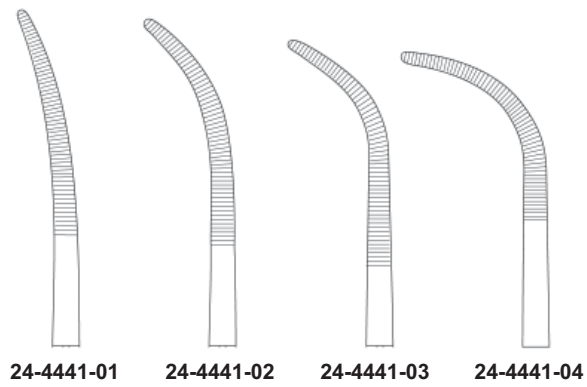

Präparier- und Ligaturklemmen
Dissecting and Ligature Forceps
Pinzas de disección y ligaduras
Pinze per preparazioni e legature

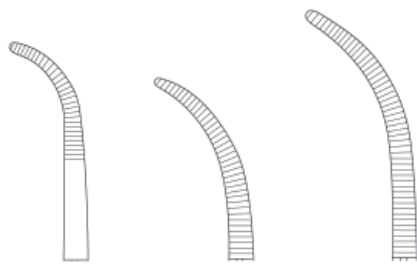

24-4421-01 20,5 cm, 7³/₄"
24-4421-02 20,0 cm, 7¹/₂"
24-4421-03 21,5 cm, 8¹/₄"

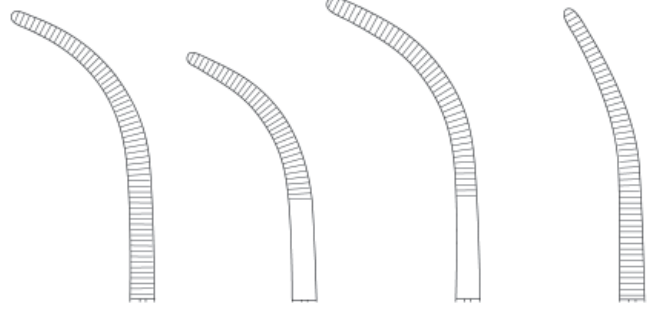

24-4421-04 22,0 cm, 8³/₄"
24-4421-05 21,5 cm, 8¹/₂"
24-4421-06 22,0 cm, 8³/₄"
24-4421-07 22,0 cm, 8³/₄"

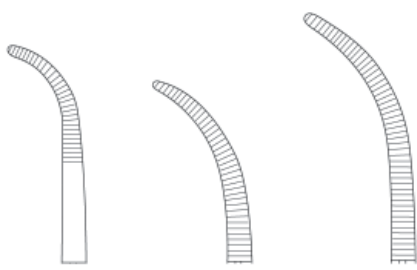

24-4422-01 27,0 cm, 10³/₄"
24-4422-02 26,0 cm, 10¹/₄"
24-4422-03 27,0 cm, 10³/₄"

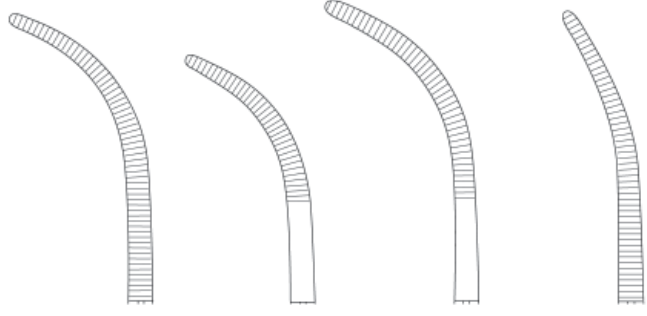

24-4422-04 27,5 cm, 10³/₄"
24-4422-05 27,5 cm, 10³/₄"
24-4422-06 28,0 cm, 11"
24-4422-07 28,0 cm, 11"



OVERHOLT-GEISSENDOERFER

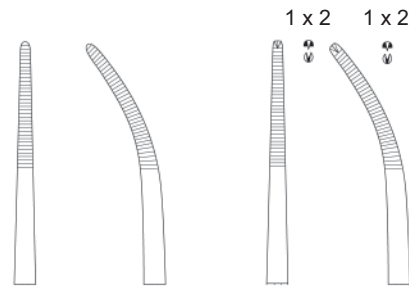

21,0 cm, 8 ¹ / ₄ "	24-4442-21	24-4443-21	24-4444-21	24-4445-21
26,0 cm, 10 ¹ / ₄ "	24-4442-26	24-4443-26	24-4444-26	24-4445-26

TOENNIS

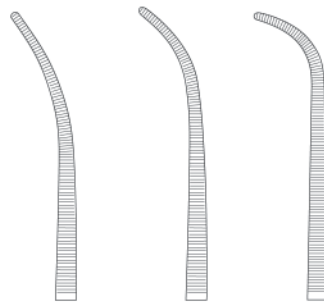

19,0 cm, 7 ¹ / ₂ "	24-4463-19	24-4465-19	24-4467-19
22,0 cm, 8 ⁵ / ₈ "	24-4463-22	24-4465-22	24-4467-22
24,0 cm, 9 ¹ / ₂ "	24-4463-24	24-4465-24	24-4467-24

KELLY

Präparier- und Ligaturklemmen
Dissecting and Ligature Forceps
Pinzas de disección y ligaduras
Pinze per preparazioni e legature



18,0 cm, 7"	24-4429-18
22,0 cm, 8 ⁵ / ₈ "	24-4429-22
25,0 cm, 9 ³ / ₄ "	24-4429-25
28,0 cm, 11"	24-4429-28

MINI-GEMINI

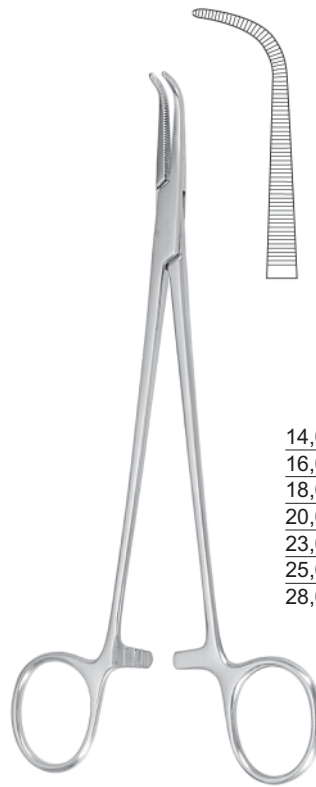

14,0 cm, 5 ¹ / ₂ "	24-4431-14
16,0 cm, 6 ¹ / ₄ "	24-4431-16
18,0 cm, 7"	24-4431-18
20,0 cm, 8"	24-4431-20
23,0 cm, 9"	24-4431-23
25,0 cm, 9 ³ / ₄ "	24-4431-25
28,0 cm, 11"	24-4431-28

GEMINI

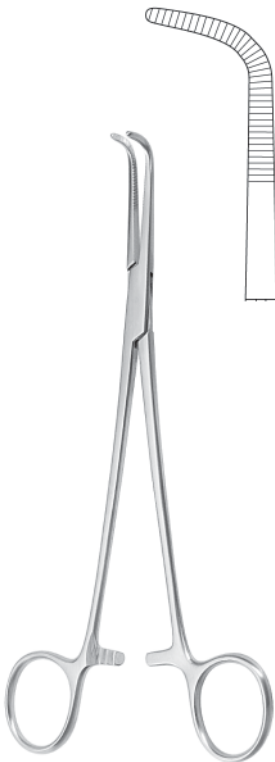

20,0 cm, 8"	24-4433-20
24,0 cm, 9 ¹ / ₂ "	24-4433-24
28,0 cm, 11"	24-4433-28

KANTROWITZ



19,0 cm, 7 ¹ / ₂ "	24-4543-19
21,0 cm, 8 ¹ / ₄ "	24-4543-21
24,0 cm, 9 ¹ / ₂ "	24-4543-24

WIKSTROEM

Präparier- und Ligaturklemmen
 Dissecting and Ligature Forceps
 Pinzas de disección y ligaduras
 Pinze per preparazioni e legature

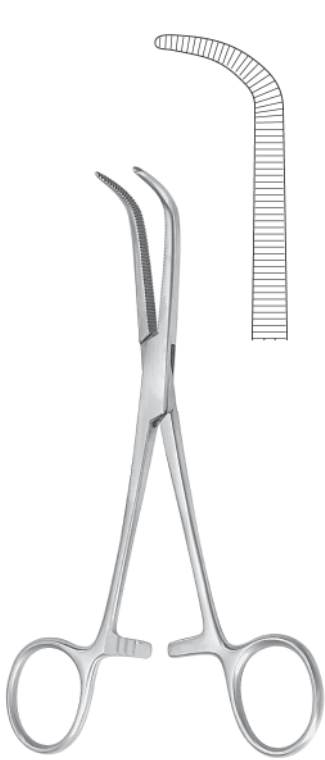

MIXTER
 15,5 cm, 6" **24-4461-15**
 19,0 cm, 7½" **24-4461-19**

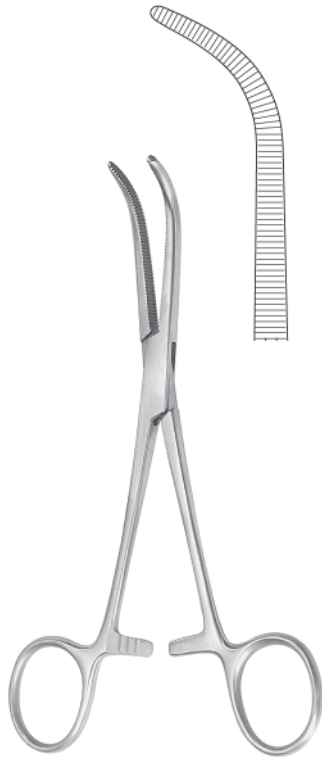

MIXTER-O'SHAUGNESSY
 15,5 cm, 6" **24-4477-15**
 19,0 cm, 7½" **24-4477-19**

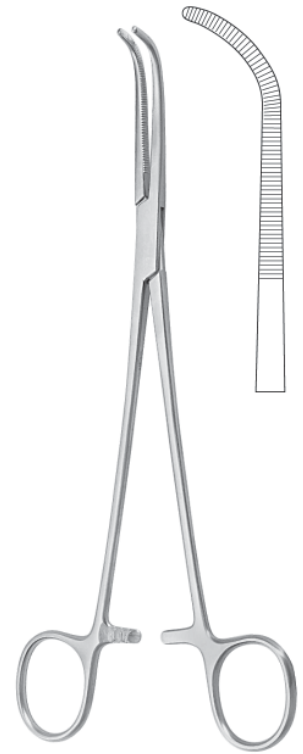

MIXTER
 22,0 cm, 8¾" **24-4473-22**



MIXTER
 23,0 cm, 9" **24-4473-23**

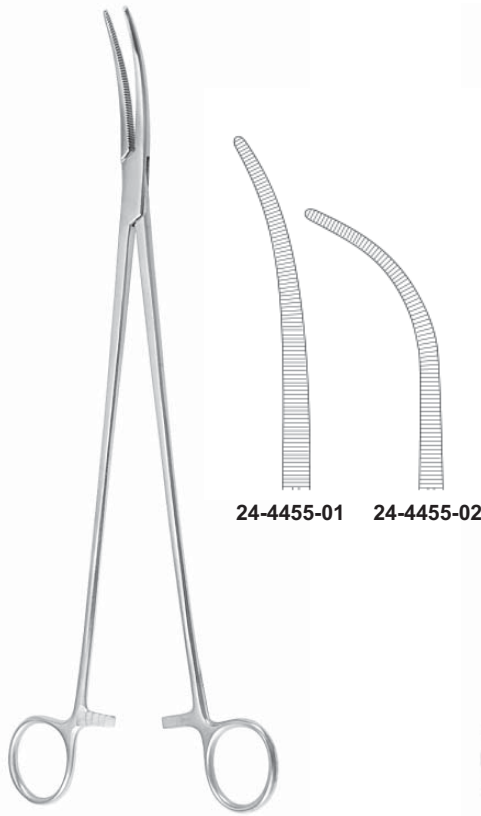

ZENKER

24-4455-01 **24-4455-02**

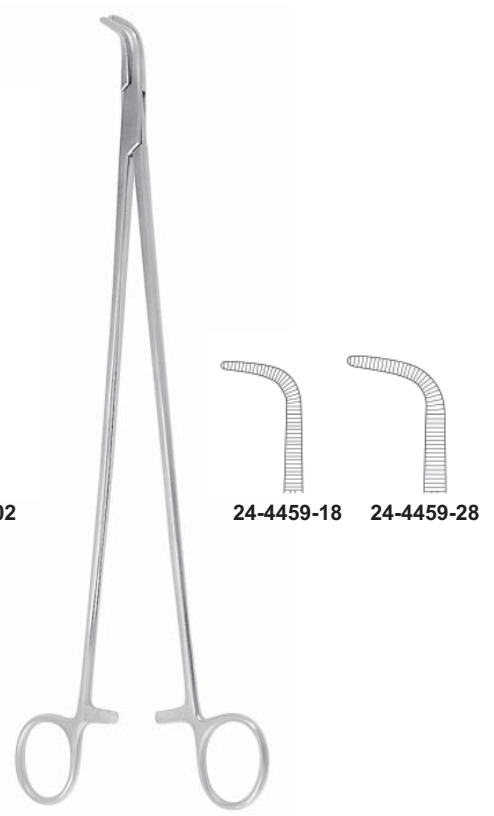

ZENKER

24-4459-18 **24-4459-28**

Präparier- und Ligaturklemmen
Dissecting and Ligature Forceps
Pinzas de disección y ligaduras
Pinze per preparazioni e legature



LAWRENCE
 27,5 cm, 10³/₄"
 24-4457-28

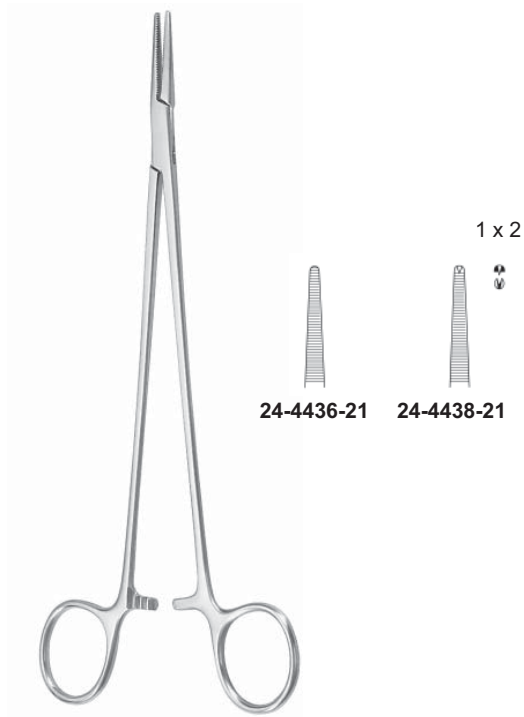

HOSEMANN
 21,0 cm, 8¹/₄"



DESJARDINS
 21,0 cm, 8¹/₄"
 24-4529-21

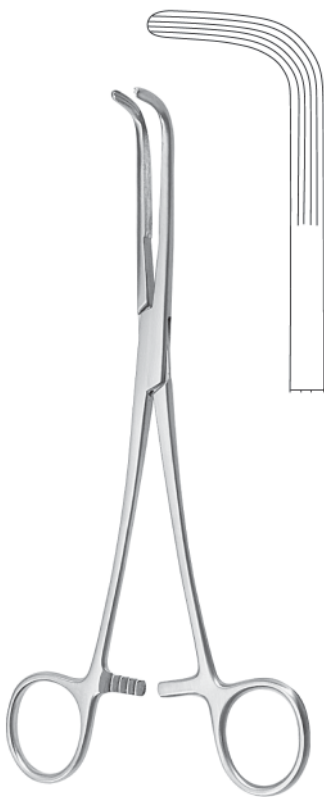

MIXTER
 22,0 cm, 8³/₄" 24-4479-22
 25,0 cm, 9³/₄" 24-4479-25
 28,0 cm, 11" 24-4479-28

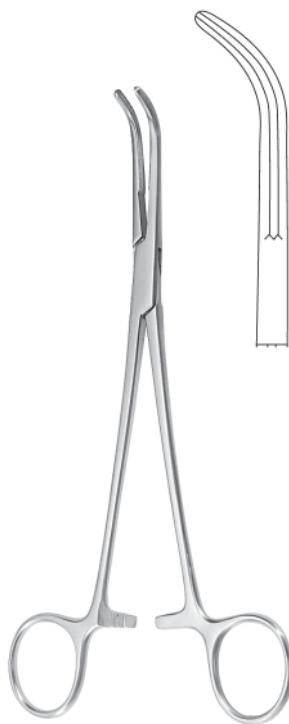

LAHEY
 19,0 cm, 7¹/₂" 24-4501-19
 23,0 cm, 9" 24-4501-23



LOWER
 18,0 cm, 7"
 24-4503-18

Präparier- und Ligaturklemmen
 Dissecting and Ligature Forceps
 Pinzas de disección y ligaduras
 Pinze per preparazioni e legature

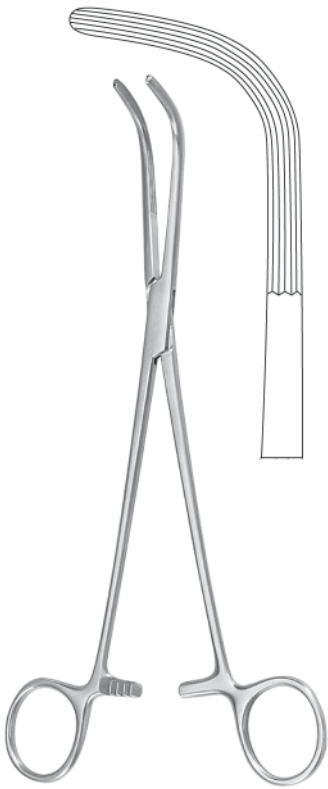

MC QUIGG-MIXTER
 22,0 cm, 8³/₄"
 24-4507-22

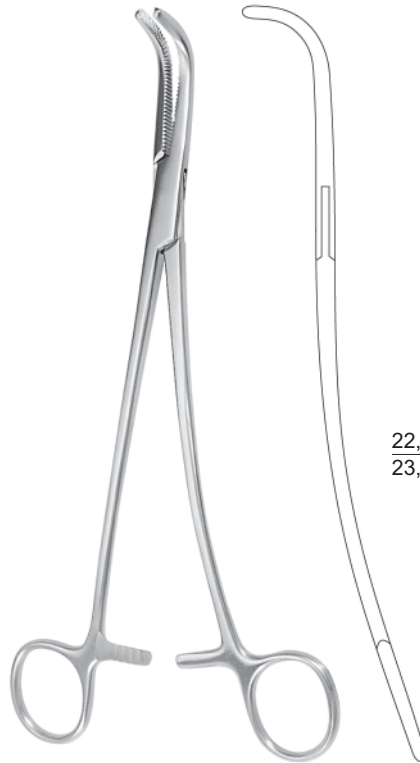

GRAY

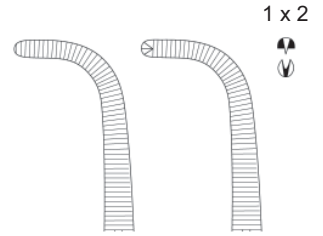

22,0 cm, 8 ³ / ₄ "	24-4523-22	24-4525-22
23,0 cm, 9"	24-4523-23	24-4525-23



CRAFOORD-SELLORS

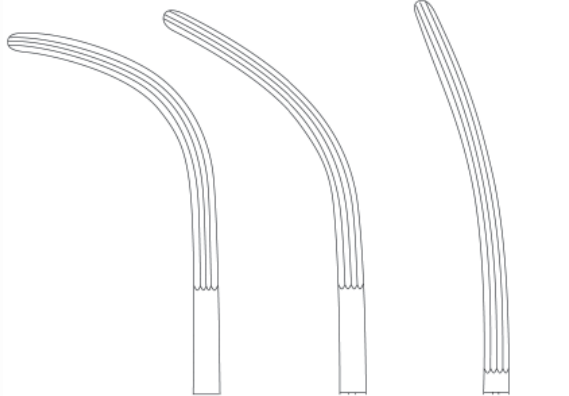

22,0 cm, 8 ³ / ₄ "	23,0 cm, 9"	24,0 cm, 9 ¹ / ₂ "
24-4456-22	24-4456-23	24-4456-24

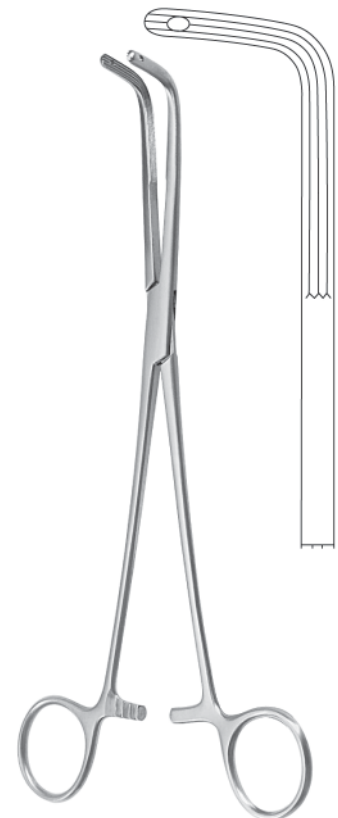

FINOCCHIETTO
 24,0 cm, 9¹/₂"
 24-4505-24

Gallenkanal- und Nierenstielklemmen
Gall Duct and Kidney Pedicle Clamps
Pinzas-clamps para pedúnculo renal
Pinze per peduncoli renali

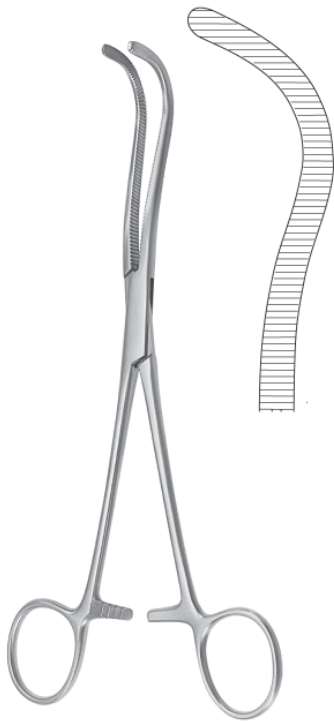

GUYON

20,0 cm, 8"	24-4509-20
22,0 cm, 8 ³ / ₄ "	24-4509-22
24,0 cm, 9 ¹ / ₂ "	24-4509-24

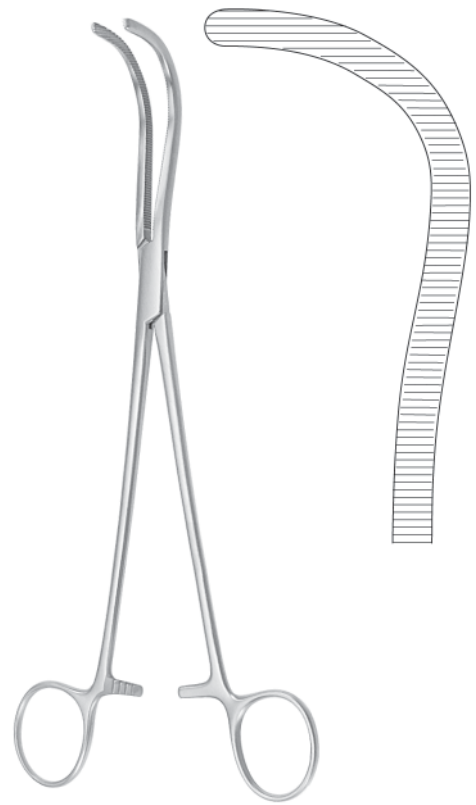

GUYON

23,0 cm, 9"
24-4513-23

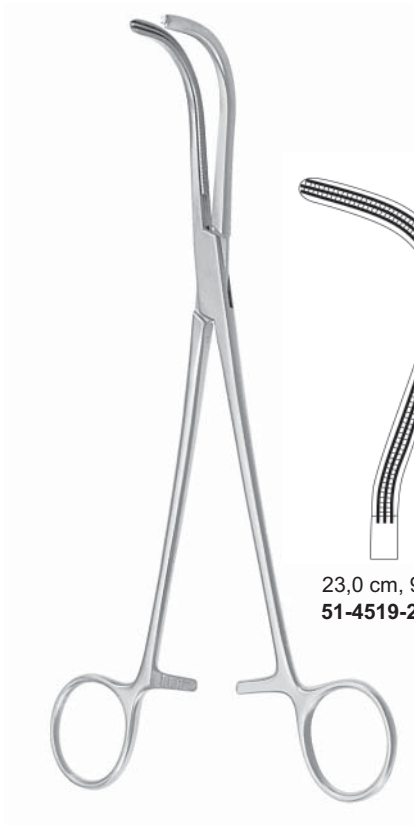

GUYON

23,0 cm, 9"
51-4519-23

24,0 cm, 9¹/₂"
51-4519-24

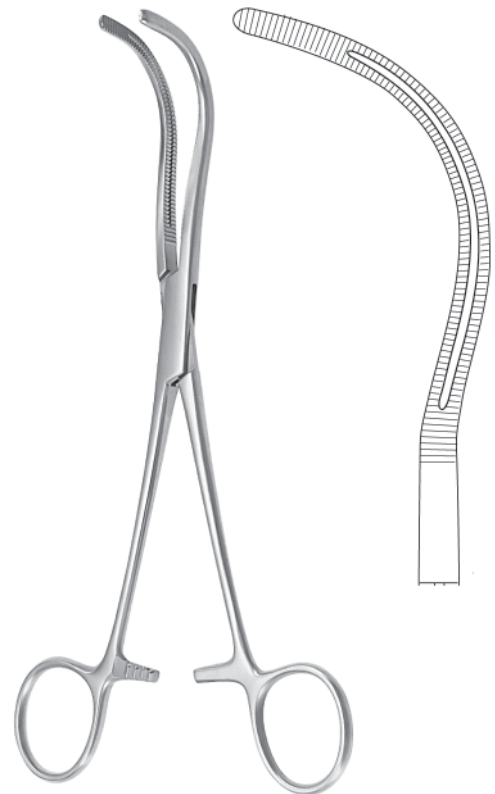

STILLE

23,0 cm, 9"
24-4511-23

Gallenkanal- und Nierenstielklemmen, Bronchusklemmen
 Gall Duct and Kidney Pedicle Clamps, Bronchus Forceps
 Pinzas-clamps para pedúnculo renal, Pinzas-clamps para bronquios
 Pinze per peduncoli renali, Pinze per legature



HERRICK
 23,0 cm, 9"
 24-4517-23

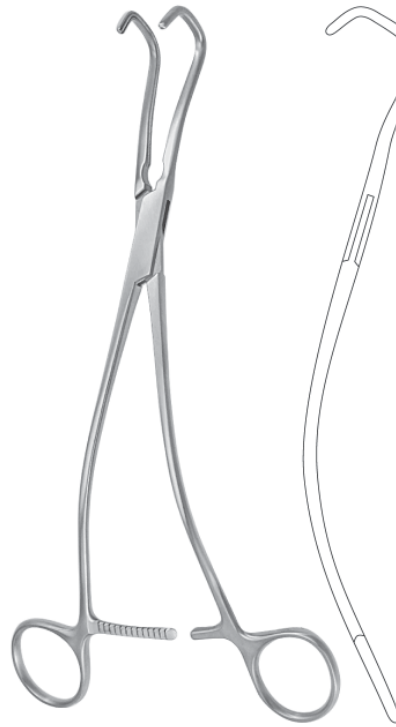

URO-TANGENTIAL

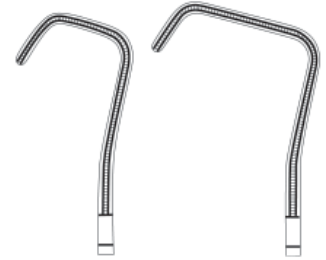

23,0 cm, 9"
 56-4055-01

24,0 cm, 9½"
 56-4055-02



LOVELACE
 20,0 cm, 8"
 48-4004-20



LOVELACE
 20,0 cm, 8"
 48-4005-20



PRICE-THOMAS
 22,0 cm, 8¾"
 48-4001-22

Bronchusklemmen, Peritoneumklemmen, Hysterektomieklemmen
 Bronchus Forceps, Peritoneum Forceps, Hysterectomy Forceps
 Pinzas-clamps para bronquios, Pinzas-clamps para peritoneo y para histerectomía
 Pinze per legature, Pinze per peritoneo e per isterectomia



PRICE-THOMAS
 22,0 cm, 8³/₄"

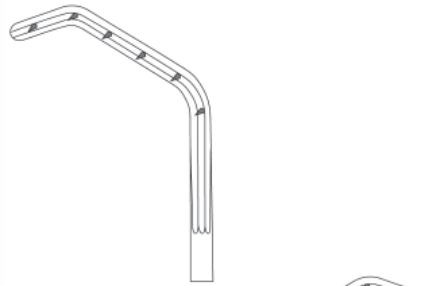

48-4002-01

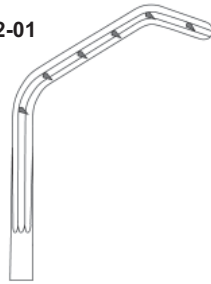

48-4002-02



SEMB
 24,0 cm, 9¹/₂"

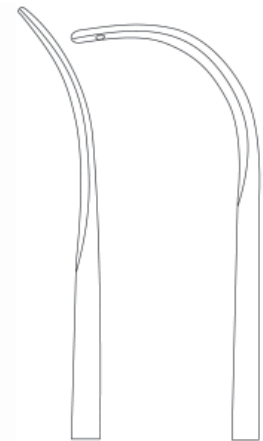

48-4003-01

48-4003-02

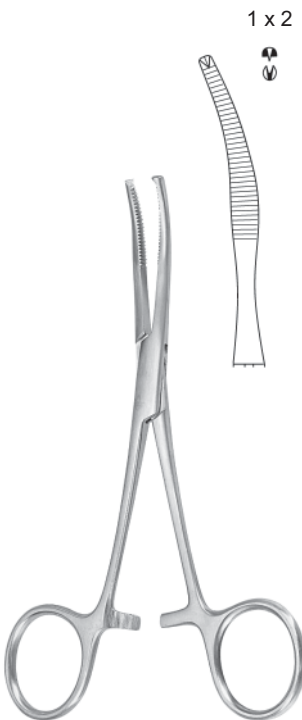

BABY-MIKULICZ
 14,0 cm, 5¹/₂"
 24-4701-14

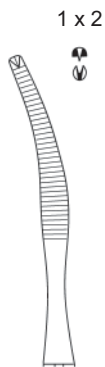

1 x 2

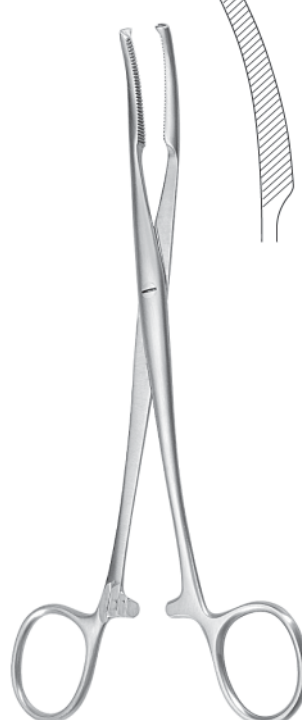

MIKULICZ
 18,0 cm, 7"
 24-4703-18

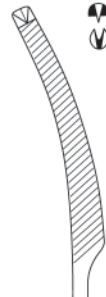

1 x 2



MIKULICZ
 20,0 cm, 8"
 24-4709-20



1 x 2



Peritoneumklemmen, Hysterektomieklemmen
 Peritoneum Forceps, Hysterectomy Forceps
 Pinzas-clamps para peritoneo y para histerectomía
 Pinze per peritoneo e per isterectomia

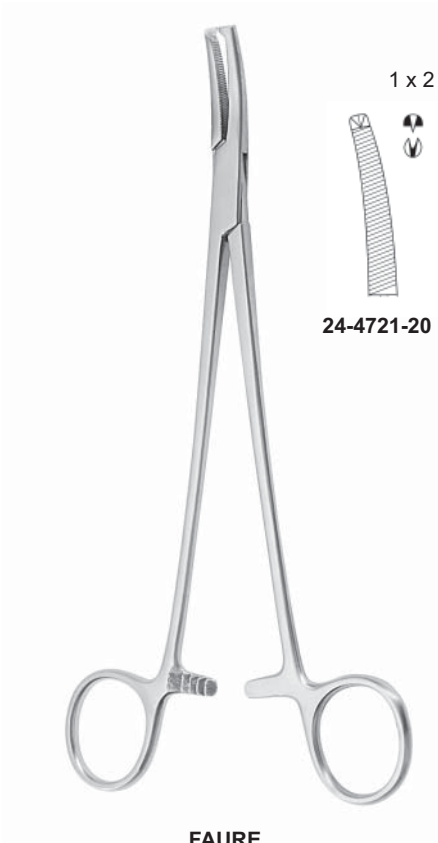

FAURE
 20,0 cm, 8"

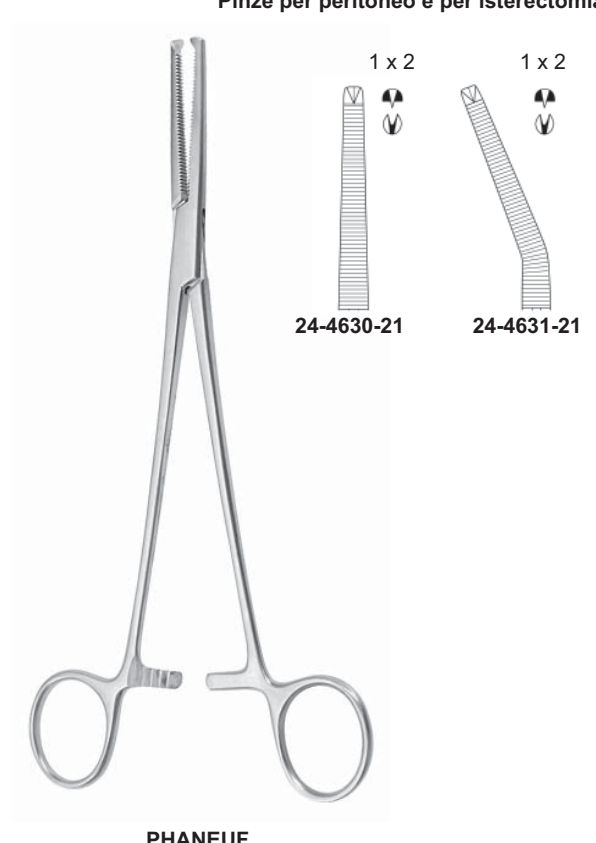

PHANEUF
 21,5 cm, 8½"

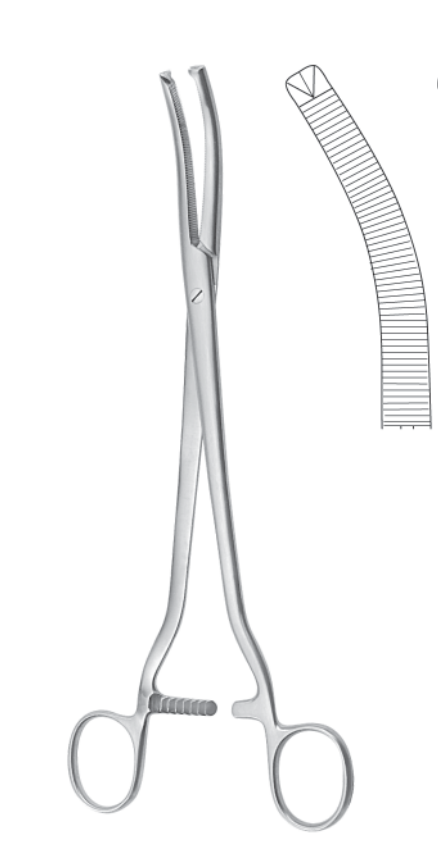

WERTHEIM
 24,0 cm, 9½"
 24-4601-24



WERTHEIM
 25,0 cm, 10"
 24-4602-25

Hysterektomieklemmen
Hysterectomy Forceps
Pinzas-clamps para histerectomía
Pinze per isterectomia

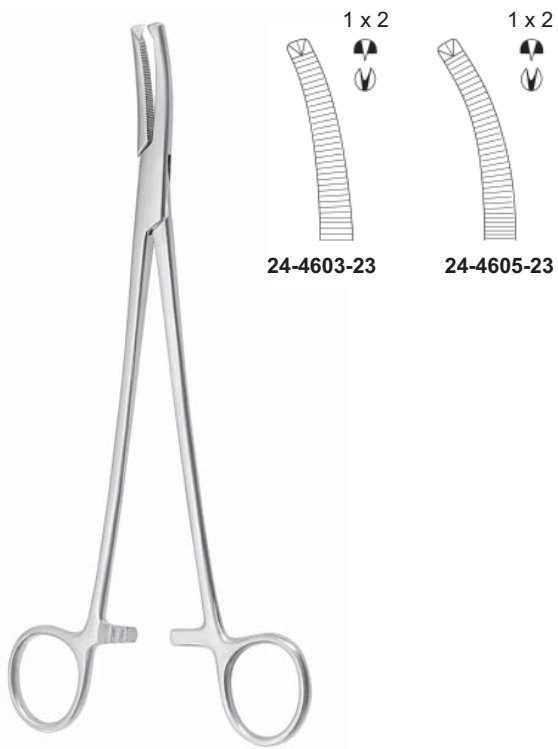

24-4603-23

24-4605-23

WERTHEIM
 23,0 cm, 9"

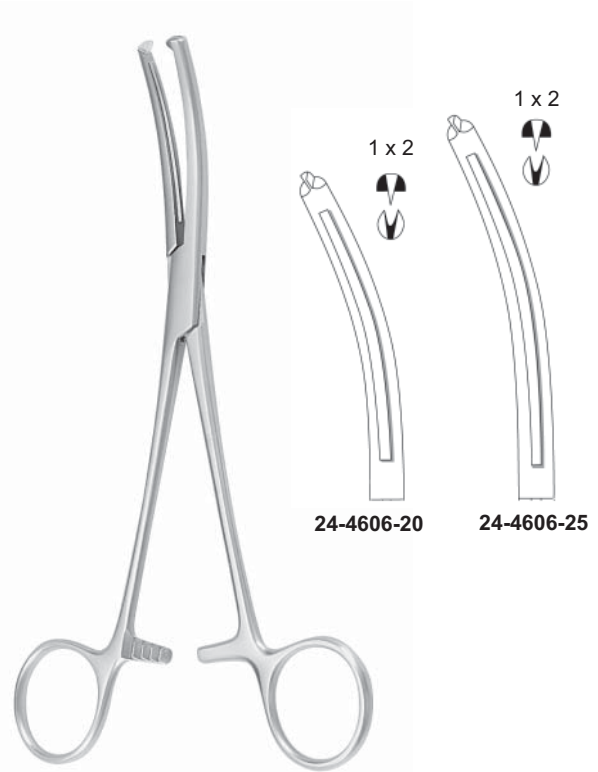

24-4606-20

24-4606-25

MAINGOT
 21,5 cm, 8½"



23,0 cm, 9"
 24-4625-23

24,0 cm, 9½"
 24-4627-24

MOYNIHAN



WERTHEIM-CULLEN
 21,5 cm, 8½"
 24-4629-21

Hysterektomieklemmen
 Hysterectomy Forceps
 Pinzas-clamps para histerectomía
 Pinze per isterectomia

1 x 2

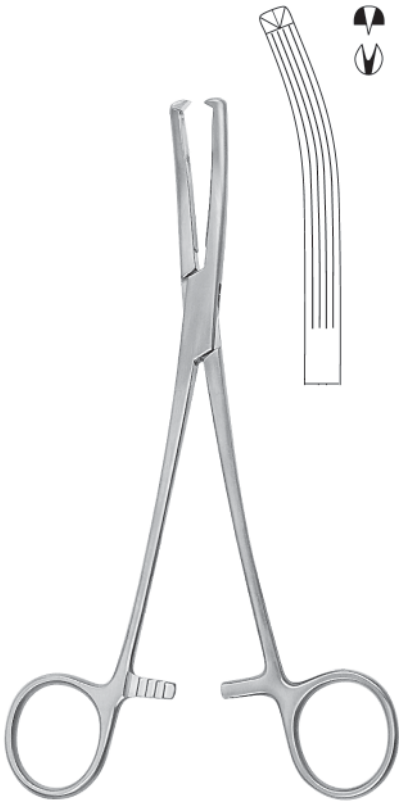

LONG
 19,0 cm, 7 1/4"
 24-4621-19

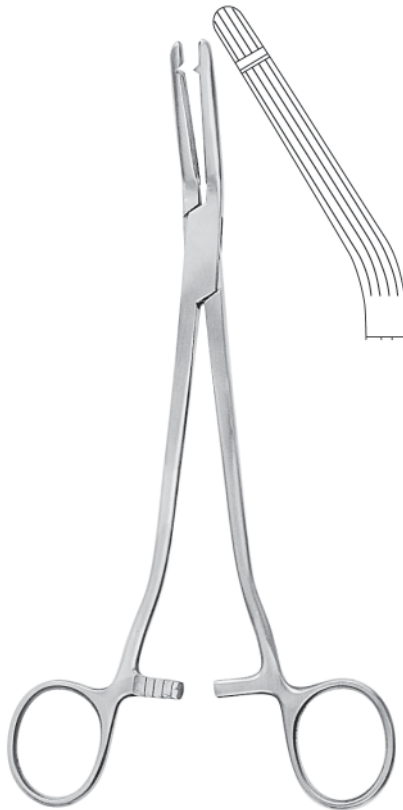

GARLAND
 21,0 cm, 8 1/4"
 24-4623-21



HEANEY
 21,0 cm, 8 1/4"
 24-4607-21



HEANEY-BALLANTINE
 21,0 cm, 8 1/4"

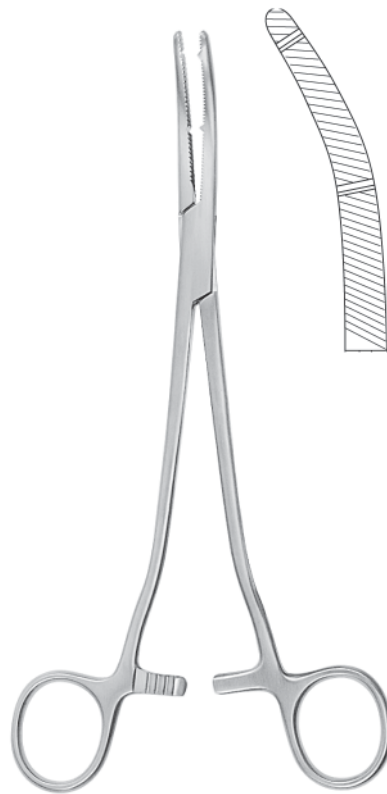
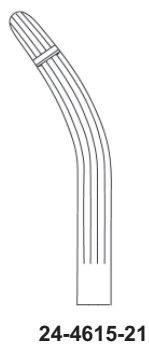
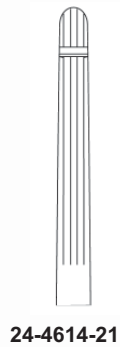

HEANEY-KANTER
 21,0 cm, 8 1/4"
 24-4617-21

Hysterektomieklemmen
Hysterectomy Forceps
Pinzas-clamps para histerectomía
Pinze per isterectomia



HEANEY

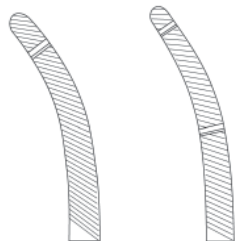

21,0 cm, 8 ¹ / ₄ "	24-4611-21	24-4613-21
23,0 cm, 9"	24-4611-23	24-4613-23

Nahtinstrumente
Suture Instruments
Instrumentos para sutura
Strumenti per sutura



Nadelhalter
Needle Holders
Porta-agujas
Portaghi



25-4010-12
 12,0 cm, 4³/₄"

25-4020-12
 12,5 cm, 5"

DERF





COLLIER
 12,5 cm, 5"
25-4022-12



WEBSTER
 13,0 cm, 5"
25-4028-13



25-4030-13

25-4040-13

HALSEY
 13,0 cm, 5"



NEIVERT
 13,0 cm, 5"
25-4046-13



HEGAR-BAUMGARTNER
 14,0 cm, 5¹/₂"
25-4048-14

Nadelhalter
Needle Holders
Porta-agujas
Portaghi

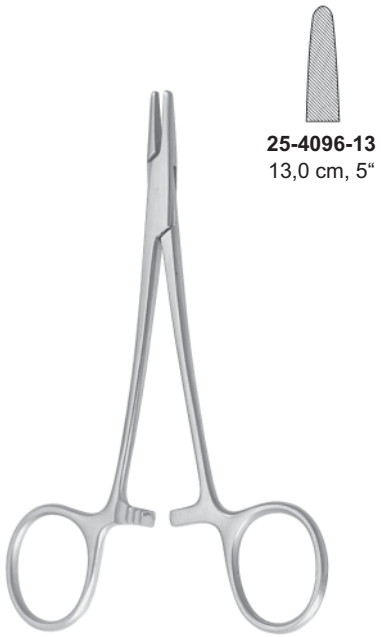

25-4096-13
13,0 cm, 5"

BROWN



CRILE-MURRAY
15,0 cm, 6"
25-4070-15

CRILE-MURRAY



25-4060-15
15,0 cm, 6"

CRILE-WOOD



ADSON
18,0 cm, 7"
25-4192-18

ADSON



METZENBAUM
18,0 cm, 7"
25-4190-18

METZENBAUM



MASS.-GENERAL-HOSPITAL
17,0 cm, 6³/₄"
25-4072-17

MASS.-GENERAL-HOSPITAL

Nadelhalter
Needle Holders
Porta-agujas
Portaghi

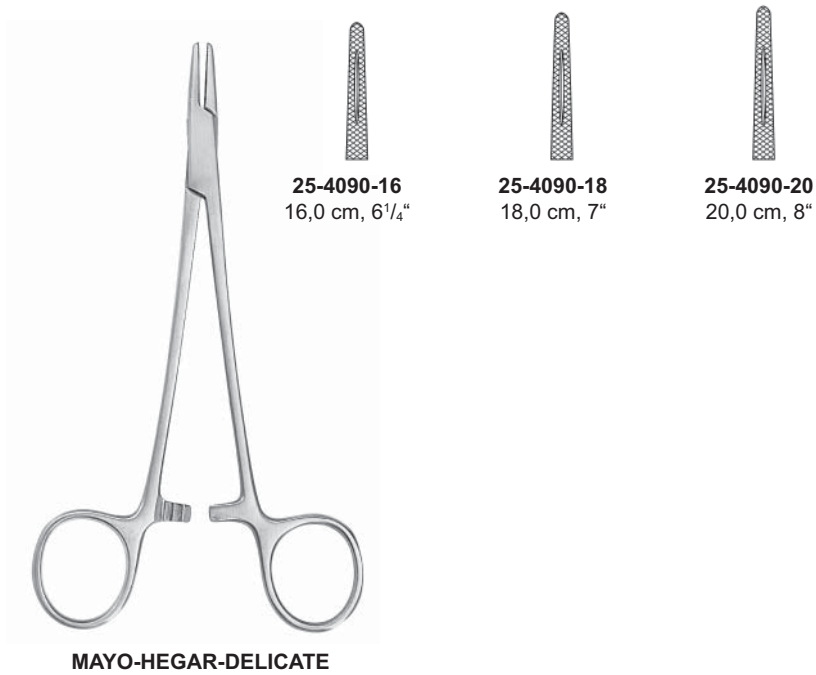
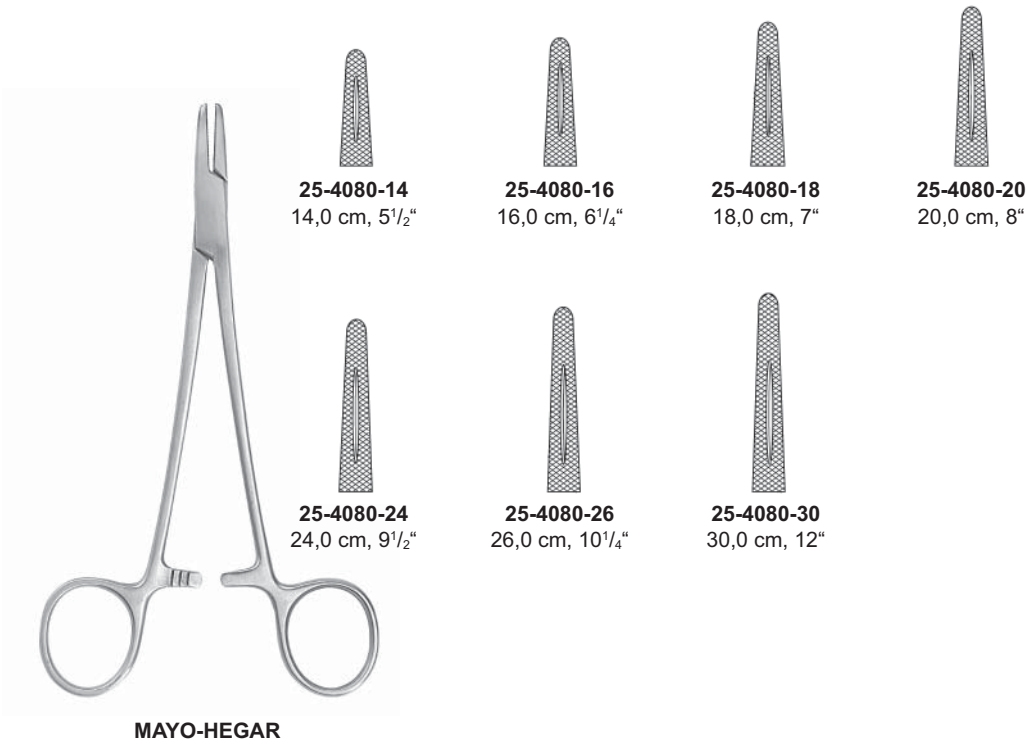

Nadelhalter
Needle Holders
Porta-agujas
Portaghi



HEANEY
21,0 cm, 8¹/₄"
25-4141-21



JAMISON
23,5 cm, 9¹/₄"
25-4148-23



MASSON
27,0 cm, 10¹/₂"
25-4150-27



FINOCCHIETTO
27,0 cm, 10¹/₂"
25-4211-27



WANGENSTEEN
27,0 cm, 10¹/₂"
25-4160-27



JOHNSON
27,0 cm, 10¹/₂"
25-4193-27

Nadelhalter
Needle Holders
Porta-agujas
Portaghi

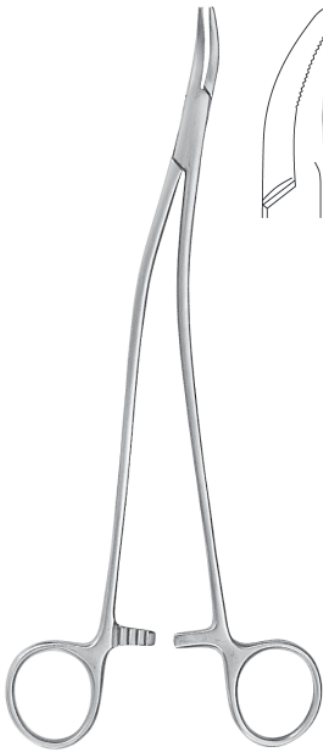

STRATTE
 23,0 cm, 9"
 25-4230-23

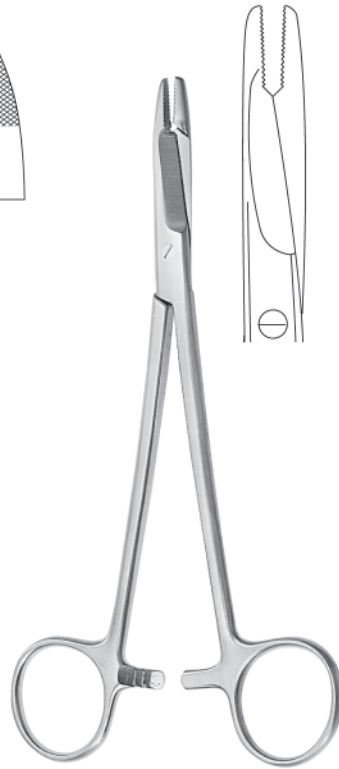

OLSEN-HEGAR
 17,0 cm, 6³/₄"
 25-4310-17

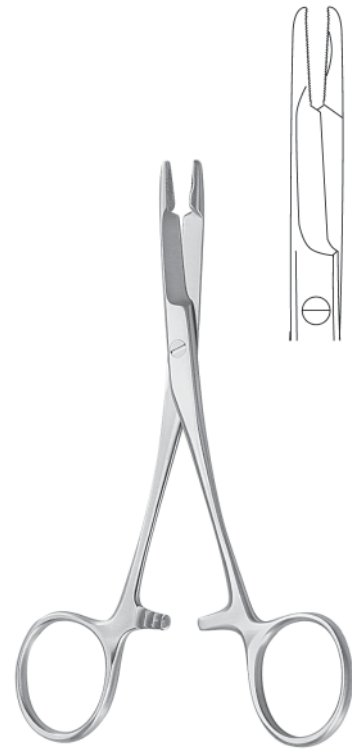

OLSEN-HEGAR
 14,0 cm, 5¹/₂"
 25-4306-14



OLSEN-HEGAR

14,0 cm, 5¹/₂"
 25-4310-14

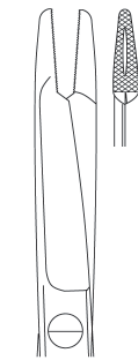

18,0 cm, 7"
 25-4310-18



TOENNIS
 18,0 cm, 7"
 25-4362-18

**Nadelhalter
Needle Holders
Porta-agujas
Portaghi**





25-4350-14
14,0 cm, 5½"

25-4350-17
17,0 cm, 6¾"

25-4350-20
20,0 cm, 8"



25-4356-17
17,0 cm, 6¾"

25-4356-20
20,0 cm, 8"

MATHIEU

MATHIEU



LICHTENBERG
20,0 cm, 8"
25-4366-20

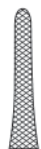

25-4354-14
14,0 cm, 5½"

25-4354-17
17,0 cm, 6¾"

MATHIEU

Nadelhalter, Mikro-Nadelhalter
Needle Holders, Micro Needle Holders
Porta-agujas, Micro Porta-agujas
Portaghi, Micro Portaghi



25-4358-14
 14,0 cm, 5 1/2"



25-4358-17
 17,0 cm, 6 3/4"

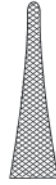

25-4358-20
 20,0 cm, 8"



25-4550-10



25-4551-10

MATHIEU-KOCHER

BARRAQUER-TROUTMAN
 10,0 cm, 4"



25-4553-10



25-4553-13

BARRAQUER



BARRAQUER
 13,5 cm, 5 3/8"
25-4621-13



GOMEL
 14,0 cm, 5 1/2"
25-4601-14

**Mikro-Nadelhalter
Micro Needle Holders
Micro Porta-agujas
Micro Portaghi**



25-4600-18 25-4601-18

ohne Sperre
without ratchet
sin cremallera
senza cremagliera

18,5 cm, 7 1/4"

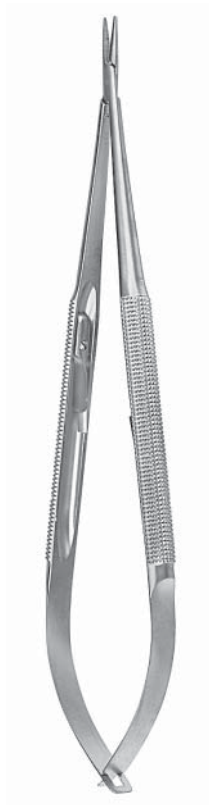

25-4630-18 25-4631-18

mit Sperre
with ratchet
con cremallera
con cremagliera

18,5 cm, 7 1/4"

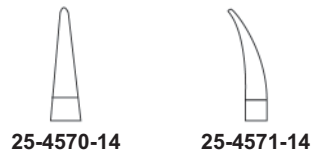

25-4570-14 25-4571-14

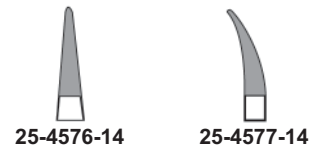

25-4576-14 25-4577-14

mit Sperre
with ratchet
con cremallera
con cremagliera

CASTROVIEJO
14,5 cm, 5 3/4"

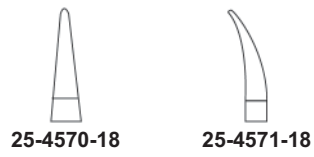

25-4570-18 25-4571-18

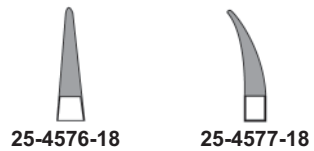

25-4576-18 25-4577-18

mit Sperre
with ratchet
con cremallera
con cremagliera

CASTROVIEJO
18,0 cm, 7"

Mikro-Nadelhalter
Micro Needle Holders
Micro Porta-agujas
Micro Portaghi

0,4 mm



gerade, ohne Sperre
 straight, without ratchet
 recta, sin cremallera
 retta, senza cremagliera

14,0 cm, 5 1/2"
25-4650-14

0,4 mm



gebogen, ohne Sperre
 curved, without ratchet
 curva, sin cremallera
 curva, senza cremagliera

14,0 cm, 5 1/2"
25-4651-14

0,4 mm



gebogen, mit Sperre
 curved, with ratchet
 curva, con cremallera
 curva, con cremagliera

14,0 cm, 5 1/2"
25-4653-14

0,5 mm



gebogen, ohne Sperre
 curved, without ratchet
 curva, sin cremallera
 curva, senza cremagliera

Ø 10 mm

14,0 cm, 5 1/2"
25-4661-14

0,5 mm



gebogen, mit Sperre
 curved, with ratchet
 curva, con cremallera
 curva, con cremagliera

Ø 10 mm

14,0 cm, 5 1/2"
25-4663-14

0,4 mm



gebogen, ohne Sperre
 curved, without ratchet
 curva, sin cremallera
 curva, senza cremagliera

Ø 8 mm

13,0 cm, 5"
25-4671-13

0,4 mm



gebogen, ohne Sperre
 curved, without ratchet
 curva, sin cremallera
 curva, senza cremagliera

Ø 8 mm

13,0 cm, 5"
25-4673-13

Nadelhalter mit Hartmetalleinlagen
Needle Holders with tungsten carbide inserts
Porta-agujas con bocas de carburo tungsteno
Portaghi con morsi in carburo di tungsteno



KALT
 13,5 cm, 5³/₈"
 26-4428-14



16,0 cm, 5 ³ / ₈ "	26-4250-16
18,0 cm, 7"	26-4250-18
20,0 cm, 8"	26-4250-20
23,0 cm, 9"	26-4250-23
26,0 cm, 10 ¹ / ₄ "	26-4250-26

DIETHRICH



WEBSTER
 13,0 cm, 5"
 26-4028-13



DERF
 12,0 cm, 4³/₄"
 26-4010-12



26-4048-12
 12,5 cm, 5"



26-4048-14
 14,0 cm, 5¹/₂"

HEGAR-BAUMGARTNER



WEBSTER
 13,0 cm, 5"
 26-4029-13

Nadelhalter mit Hartmetalleinlagen
Needle Holders with tungsten carbide inserts
Porta-agujas con bocas de carburo tungsteno
Portaghi con morsi in carburo di tungsteno





26-4030-13

26-4040-13

HALSEY
 13,0 cm, 5"



26-4060-15
 15,0 cm, 6"



26-4060-18
 18,0 cm, 7"

CRILE-WOOD





26-4224-18
 18,0 cm, 7"

26-4224-20
 20,0 cm, 8"

26-4224-26
 26,0 cm, 10 1/4"

SAROT

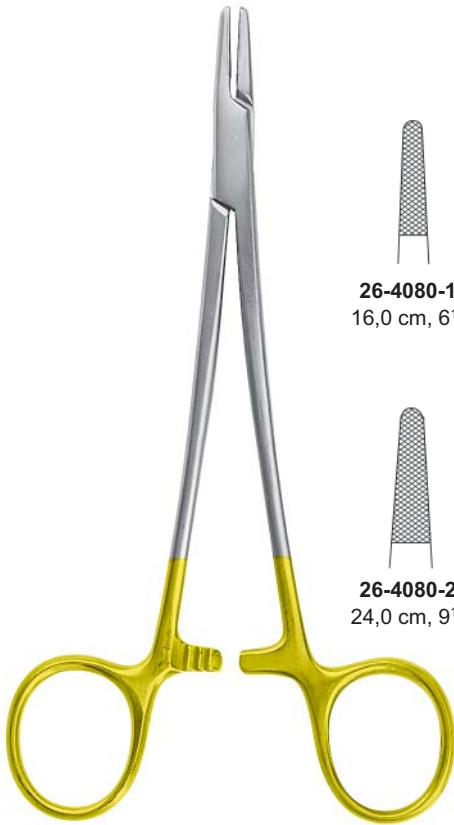
Nadelhalter mit Hartmetalleinlagen
Needle Holders with tungsten carbide inserts
Porta-agujas con bocas de carburo tungsteno
Portaghi con morsi in carburo di tungsteno



26-4080-16
16,0 cm, 6 1/4"

26-4080-18
18,0 cm, 7"

26-4080-20
20,0 cm, 8"

26-4080-24
24,0 cm, 9 1/2"

26-4080-26
26,0 cm, 10 1/4"

26-4080-30
30,0 cm, 12"

MAYO-HEGAR



26-4141-20
20,0 cm, 8"

26-4141-24
24,0 cm, 9 1/4"

26-4141-26
26,0 cm, 10 1/4"

MAYO-HEGAR (HEANEY)

Nadelhalter mit Hartmetalleinlagen
Needle Holders with tungsten carbide inserts
Porta-agujas con bocas de carburo tungsteno
Portaghi con morsi in carburo di tungsteno

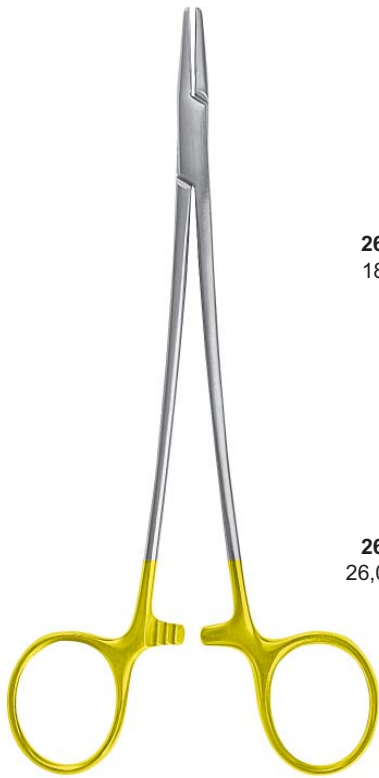

DE BAKEY



26-4114-18
18,0 cm, 7"



26-4114-20
20,0 cm, 8"



26-4114-23
23,0 cm, 9"



26-4114-26
26,0 cm, 10¹/₄"



26-4114-31
31,0 cm, 12¹/₄"



26-4114-37
37,0 cm, 14¹/₂"

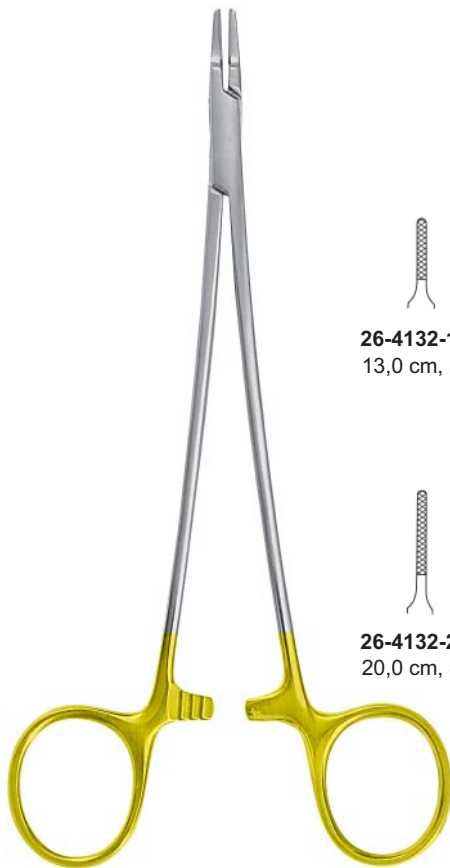

RYDER-VASCULAR



26-4132-13
13,0 cm, 5"



26-4132-15
15,0 cm, 6"



26-4132-18
18,0 cm, 7"



26-4132-20
20,0 cm, 8"



26-4132-23
23,0 cm, 9"



26-4132-26
26,0 cm, 10¹/₄"

Nadelhalter mit Hartmetalleinlagen
Needle Holders with tungsten carbide inserts
Porta-agujas con bocas de carburo tungsteno
Portaghi con morsi in carburo di tungsteno



RYDER



26-4134-13
13,0 cm, 5"

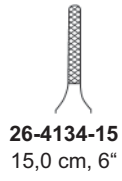

26-4134-15
15,0 cm, 6"



26-4134-18
18,0 cm, 7"

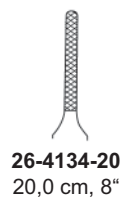

26-4134-20
20,0 cm, 8"

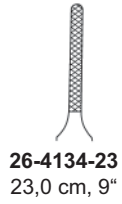

26-4134-23
23,0 cm, 9"



26-4134-26
26,0 cm, 10 1/4"

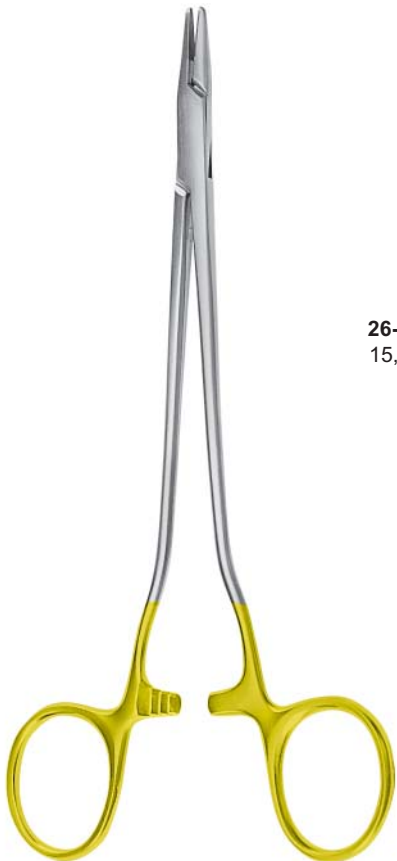

SCHWEDISCHES MODELL

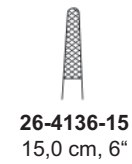

26-4136-15
15,0 cm, 6"

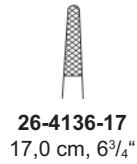

26-4136-17
17,0 cm, 6 3/4"

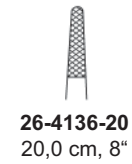

26-4136-20
20,0 cm, 8"

Nadelhalter mit Hartmetalleinlagen
Needle Holders with tungsten carbide inserts
Porta-agujas con bocas de carburo tungsteno
Portaghi con morsi in carburo di tungsteno

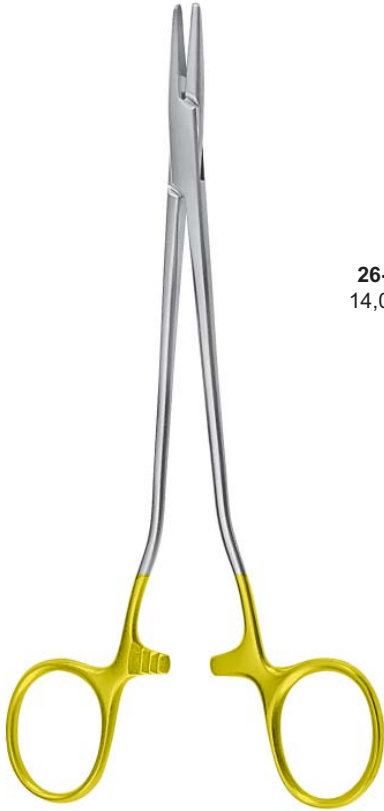

MAYO-HEGAR (HEANEY)



26-4090-14
14,0 cm, 5½"



26-4090-18
18,0 cm, 7"



26-4090-20
20,0 cm, 8"



26-4090-23
23,0 cm, 9"



FINOCCHIETTO
27,0 cm, 10½"
26-4211-27

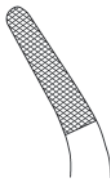

MASSON
27,0 cm, 10½"
26-4150-27



WANGENSTEEN
27,0 cm, 10½"
26-4160-27



Nadelhalter mit Hartmetalleinlagen
Needle Holders with tungsten carbide inserts
Porta-agujas con bocas de carburo tungsteno
Portaghi con morsi in carburo di tungsteno



BOZEMANN



26-4185-20
20,0 cm, 8"



26-4185-24
24,0 cm, 9⁵/₈"



26-4185-26
26,0 cm, 10¹/₄"



HEGAR



26-4084-20
20,0 cm, 8"



26-4084-24
24,0 cm, 9⁵/₈"



BARRY STERNAL



26-4240-15
15,0 cm, 6"



26-4242-20
20,0 cm, 8"

Nadelhalter mit Hartmetalleinlagen
Needle Holders with tungsten carbide inserts
Porta-agujas con bocas de carburo tungsteno
Portaghi con morsi in carburo di tungsteno



STRATTE

26-4230-22
 22,0 cm, 8⁵/₈"

26-4230-23
 23,0 cm, 9"



GILLIES
 16,0 cm, 6¹/₄"
26-4330-16



OLSEN-HEGAR

26-4310-14
 14,0 cm, 5¹/₂"

26-4310-17
 17,0 cm, 6³/₄"

26-4310-18
 18,0 cm, 7"



TOENNIS
 18,0 cm, 7"
26-4362-18

Nadelhalter mit Hartmetalleinlagen
Needle Holders with tungsten carbide inserts
Porta-agujas con bocas de carburo tungsteno
Portaghi con morsi in carburo di tungsteno



MATHIEU-KOCHER



26-4358-14
14,0 cm, 5½"



26-4358-17
17,0 cm, 6¾"



26-4358-20
20,0 cm, 8"



MATHIEU



26-4350-14
14,0 cm, 5½"



26-4350-17
17,0 cm, 6¾"



26-4350-20
20,0 cm, 8"

Nadelhalter mit Hartmetalleinlagen
Needle Holders with tungsten carbide inserts
Porta-agujas con bocas de carburo tungsteno
Portaghi con morsi in carburo di tungsteno



LICHTENBERG



26-4366-17
17,0 cm, 6³/₄"



26-4366-20
20,0 cm, 8"



MATHIEU



26-4356-17
17,0 cm, 6³/₄"



26-4356-20
20,0 cm, 8"



26-4356-23
23,0 cm, 9"

Nadelhalter mit Hartmetalleinlagen
Needle Holders with tungsten carbide inserts
Porta-agujas con bocas de carburo tungsteno
Portaghi con morsi in carburo di tungsteno

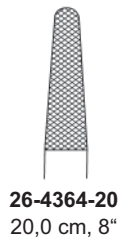

26-4364-20
20,0 cm, 8"

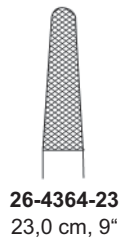

26-4364-23
23,0 cm, 9"

ZWEIFEL



26-4360-18
18,0 cm, 7"



26-4360-20
20,0 cm, 8"

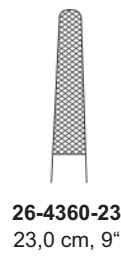

26-4360-23
23,0 cm, 9"

LANGENBECK

Nadelhalter mit Hartmetalleinlagen
Needle Holders with tungsten carbide inserts
Porta-agujas con bocas de carburo tungsteno
Portaghi con morsi in carburo di tungsteno

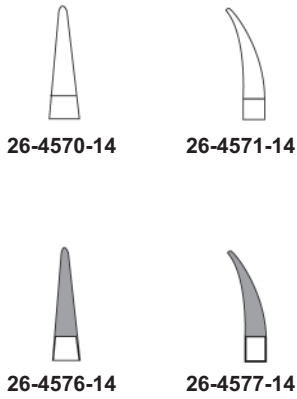

mit Sperre
 with ratchet
 con cremallera
 con cremagliera

CASTROVIEJO
 14,5 cm, 5³/₄"

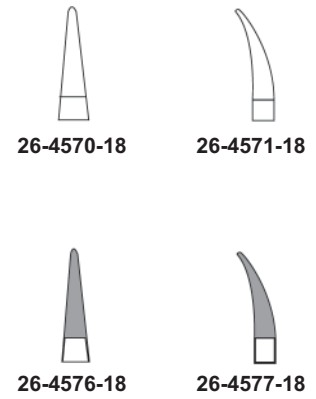

mit Sperre
 with ratchet
 con cremallera
 con cremagliera

CASTROVIEJO
 18,0 cm, 7"

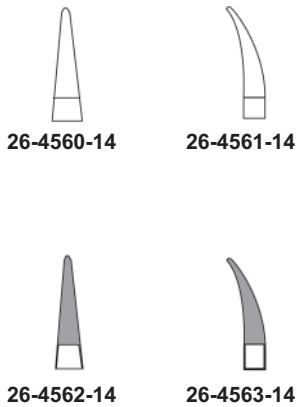

mit Sperre
 with ratchet
 con cremallera
 con cremagliera

BARRAQUER
 14,5 cm, 5³/₄"



HEPP SCHEIDEL
 18,0 cm, 7"
 26-4390-18

REVERDIN-Nadeln
 REVERDIN Needles
 Aguja de REVERDIN
 Aghi di REVERDIN



REVERDIN
 14,0 cm, 5½"

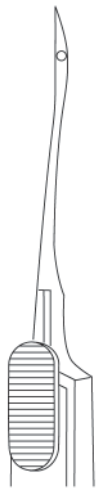

27-4211-01



27-4211-02



27-4211-03

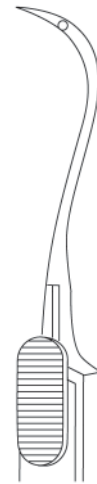

27-4211-04



REVERDIN



19,5 cm, 7¾"
 22,5 cm, 8¾"

27-4221-01



27-4221-02



27-4221-03



27-4221-04



27-4223-01



27-4223-02



27-4223-03



27-4223-04

Unterbindungsnadeln
Ligature Needles
Agujas para ligaduras
Aghi per legatura

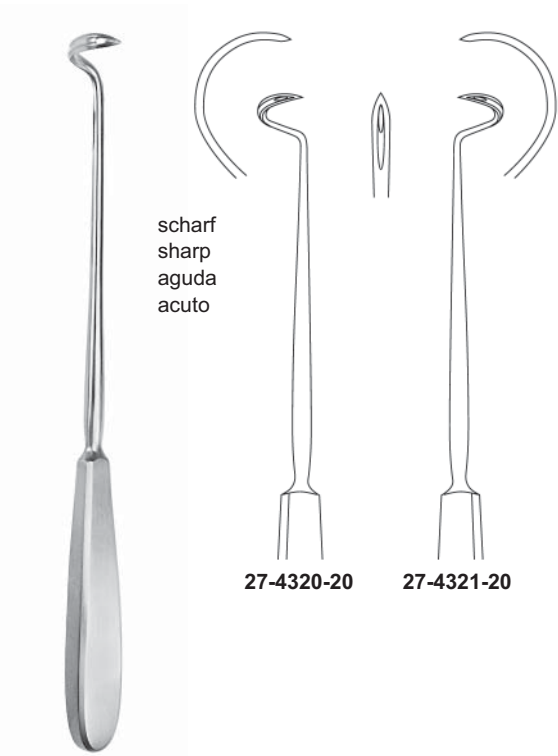

scharf
 sharp
 aguda
 acuto

27-4320-20

27-4321-20

DESCHAMPS
 20,0 cm, 8"

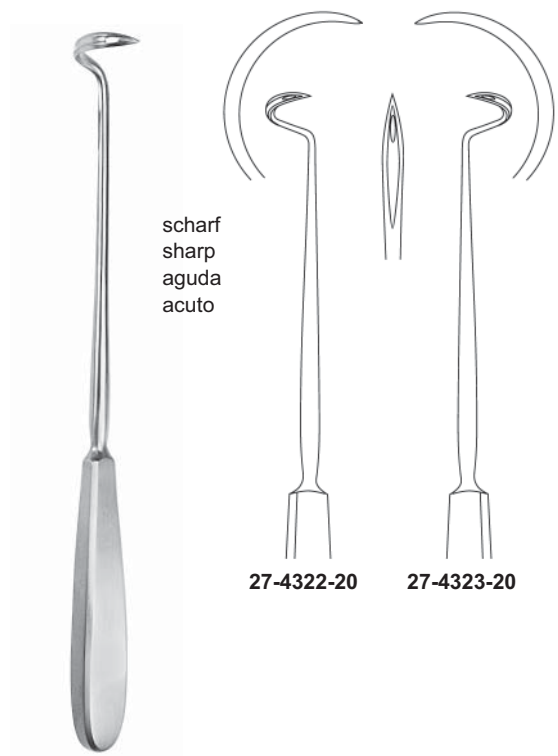

scharf
 sharp
 aguda
 acuto

27-4322-20

27-4323-20

DESCHAMPS
 20,0 cm, 8"

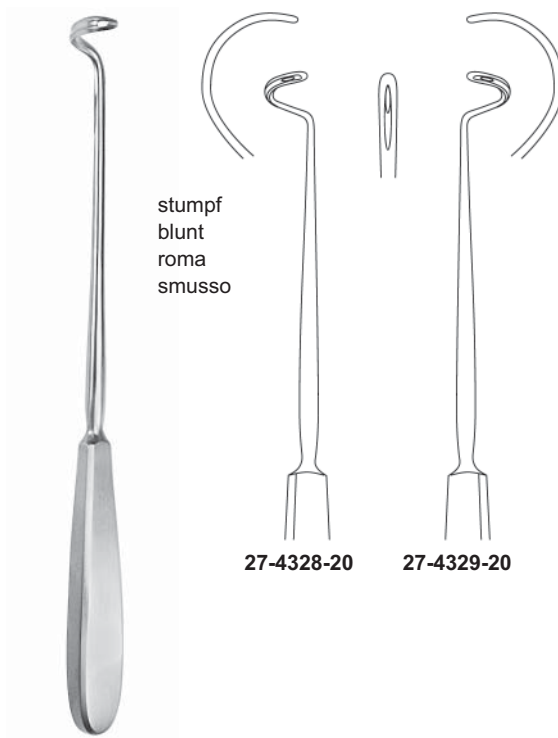

stumpf
 blunt
 roma
 smusso

27-4328-20

27-4329-20

DESCHAMPS
 20,0 cm, 8"

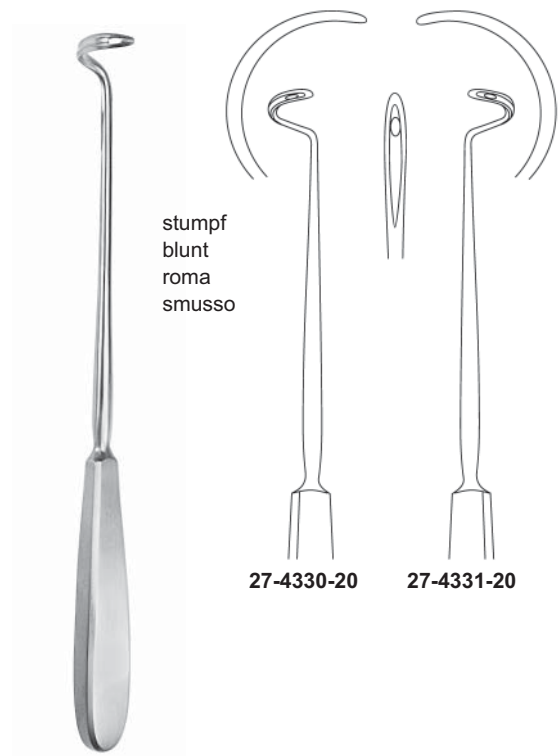

stumpf
 blunt
 roma
 smusso

27-4330-20

27-4331-20

DESCHAMPS
 20,0 cm, 8"

Unterbindungsnadeln
 Ligature Needles
 Agujas para ligaduras
 Aghi per legatura

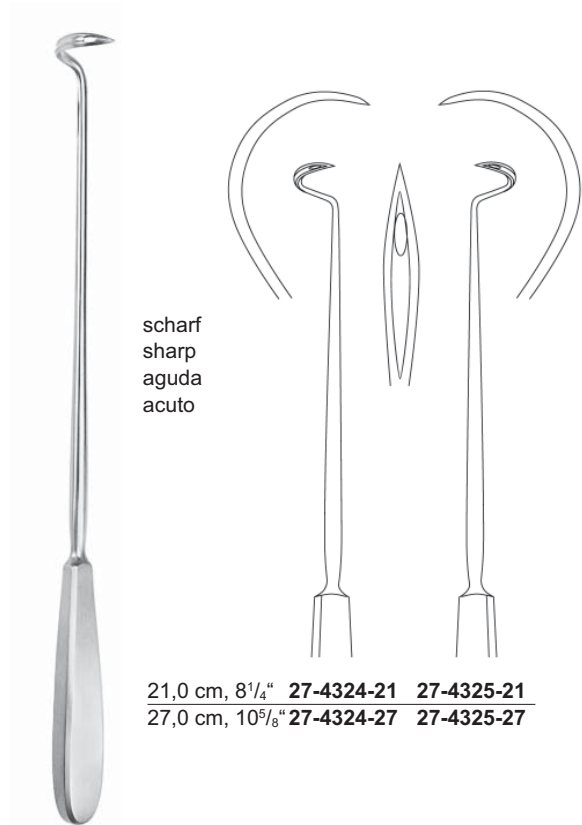

scharf
 sharp
 aguda
 acuto

21,0 cm, 8¹/₄" 27-4324-21 27-4325-21
 27,0 cm, 10⁵/₈" 27-4324-27 27-4325-27

DESCHAMPS

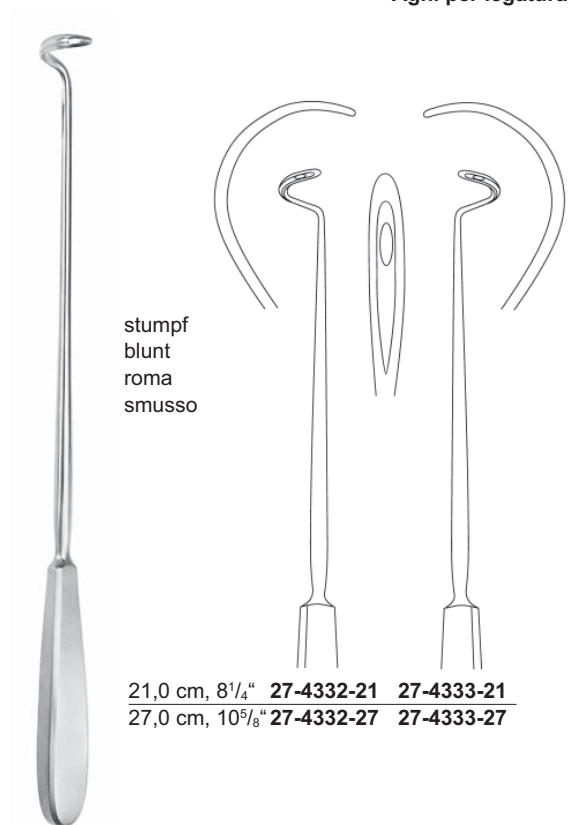

stumpf
 blunt
 roma
 smusso

21,0 cm, 8¹/₄" 27-4332-21 27-4333-21
 27,0 cm, 10⁵/₈" 27-4332-27 27-4333-27

DESCHAMPS



biegsam
 malleable
 maleable
 malleabile

20,0 cm, 8"
 27-4450-20



COOPER
 19,0 cm, 7¹/₂"
 27-4451-19



COOPER
 20,0 cm, 8"
 27-4451-20



SYME
 15,0 cm, 6"
 27-4453-15

Unterbindungsnadeln
Ligature Needles
Agujas para ligaduras
Aghi per legatura



27-4452-01

KOCHER
19,0 cm, 7¹/₂"



27-4452-02



27-4452-03



BRUNNER
25,0 cm, 9³/₄"
27-4455-25



27-4454-01

BRUNNER
30,0 cm, 11³/₄"



27-4454-02



SCHMIEDEN
21,0 cm, 8¹/₄"
27-4458-21

Unterbindungsnadeln
 Ligature Needles
 Agujas para ligaduras
 Aghi per legatura



YOUNG-HRYNTSCHAK
 24,0 cm, 9½"
 27-4460-24



27-1460-01



27-1460-02

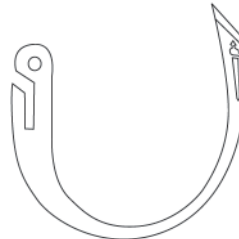

27-1460-03



DE LA ROZA
 12,0 cm, 4¾"
 27-4467-01



DE LA ROZA
 12,0 cm, 4¾"
 27-4467-02



JAKOBI
 14,0 cm, 5½"
 27-4469-14



HESSEBERG
 15,0 cm, 6"
 27-4468-15



KRONECKER
 15,0 cm, 6"
 27-4470-01

Unterbindungsnadeln
Ligature Needles
Agujas para ligaduras
Aghi per legatura



KRONECKER
 15,0 cm, 6"
 27-4470-02



TRÉLAT
 23,0 cm, 9"
 27-4472-23



CLAUS
 23,0 cm, 9"
 27-4473-23



HURD
 21,0 cm, 8 1/4"
 27-4474-01



HURD
 21,0 cm, 8 1/4"
 27-4474-02



NAGER
 24,0 cm, 9 1/2"
 27-4477-24



CLAUS-EICKEN
 23,0 cm, 9"
 27-4481-23



FALK
 24,0 cm, 9 1/2"
 27-4480-01



FALK
 24,0 cm, 9 1/2"
 27-4480-02

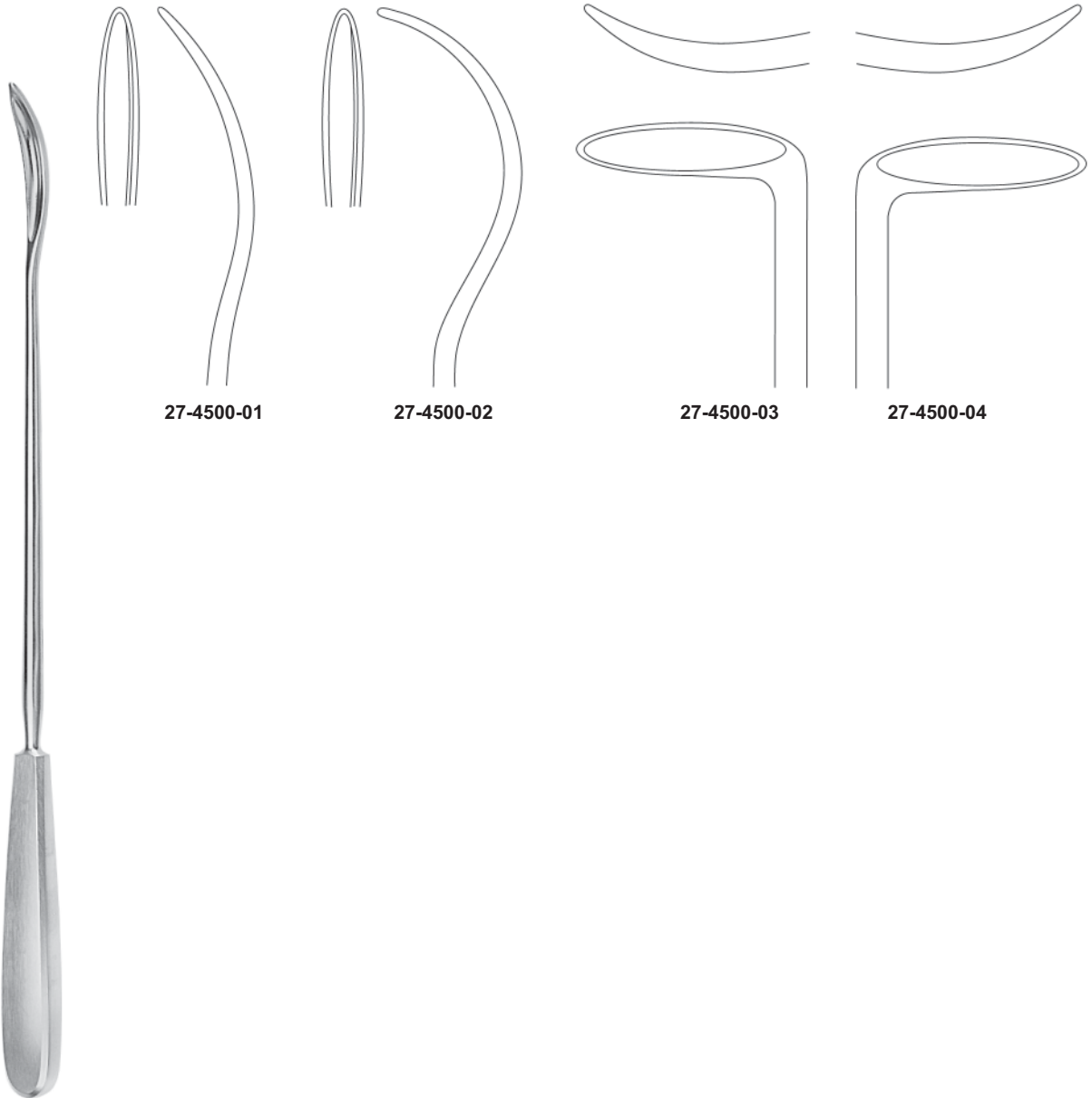

BRUNNER
30,0 cm, 11³/₄"

**Führungshohlsonden
Ligature Conductors
Sondas conductoras
Sonde conduttrici**



PAYR
22,0 cm, 8⁵/₈"
27-4502-22



PAYR
22,0 cm, 8⁵/₈"
27-4503-22



mit Loch
with hole
con foro
con ago

SCHMIEDEN-PAYR
19,0 cm, 7¹/₂"
27-4506-19



ohne Loch
without hole
sin foro
senza ago

SCHMIEDEN
19,0 cm, 7¹/₂"
27-4507-19



KÖNIG
19,5 cm, 7³/₄"
27-4508-03



KÖNIG
19,5 cm, 7³/₄"
27-4508-05



KÖNIG
19,5 cm, 7³/₄"
27-4508-07

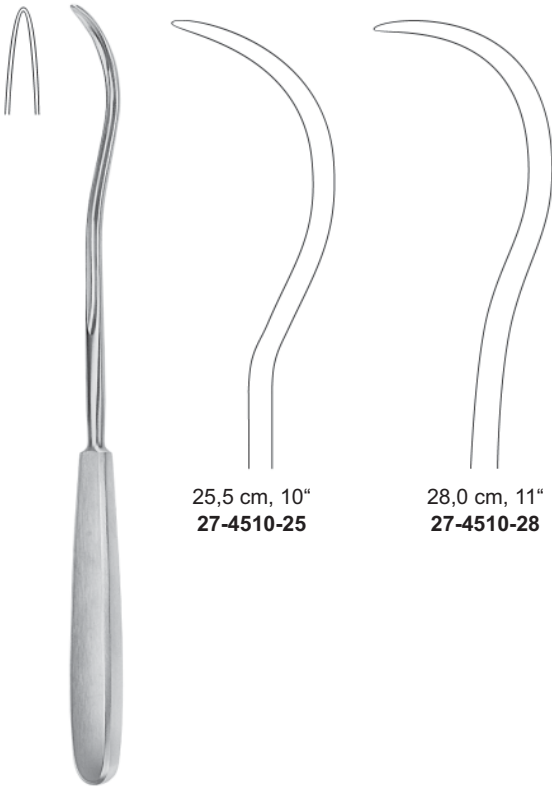

25,5 cm, 10"
 27-4510-25

28,0 cm, 11"
 27-4510-28

KIRSCHNER



BRUNNER-FERROZELL
 18,0 cm, 7" 27-4521-18
 27,0 cm, 10⁵/₈" 27-4521-27



KOCHER



15,0 cm, 6" 27-4513-15 27-4514-15
 16,0 cm, 6¹/₄" 27-4513-16 27-4514-16



18,0 cm, 7"
 27-4516-18

Nahtinstrumente
Suture Instruments
Instrumentos para sutura
Strumenti per sutura



MOD. WIEN
 23,5 cm, 9¹/₄"
 27-4532-23



BOZEMANN
 21,0 cm, 8¹/₄"
 27-4531-21



23,0 cm, 9"
 27-4530-23



MICHEL
 12,0 cm, 4³/₄"
 27-4550-12



COLLIN
 13,0 cm, 5"
 27-4552-13



RICHTER-HEATH
 14,0 cm, 5¹/₂"
 27-4553-14



WACHENFELDT
 12,5 cm, 5"
 27-4555-01



HEGENBARTH
 12,5 cm, 5"
 27-4556-12



MICHEL
12,0 cm, 4³/₄"
27-4558-12



LANGE
10,0 cm, 4"
27-4559-10



CHILDE
18,0 cm, 7"
27-4560-01



CHILDE CLIP
18,0 cm, 7"
27-4560-02

	27-4570-08	7,5 x 1,75 mm
	27-4570-11	11,0 x 2,0 mm
	27-4570-12	12,0 x 3,0 mm
	27-4570-14	14,0 x 3,0 mm
	27-4570-16	16,0 x 3,0 mm
	27-4570-18	18,0 x 3,0 mm
	27-4570-20	20,0 x 3,0 mm
	27-4570-22	22,0 x 3,0 mm

MICHEL

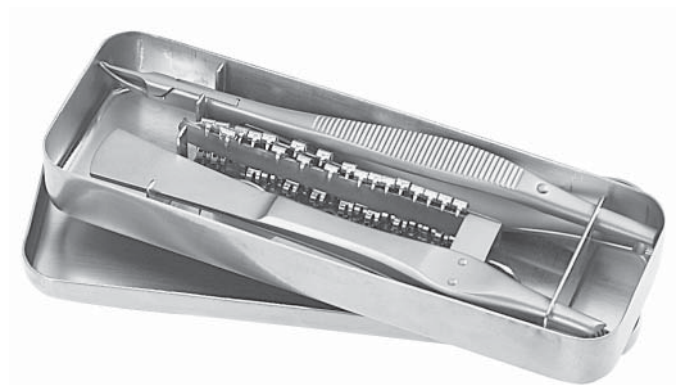

CLIP-SET
27-1558-00

bestehend aus, consisting of, compuesto de, composto da

- 1 x **27-4558-12**
- 1 x **27-4550-12**
- 50 x **27-4570-14**
- 1 x **27-4590-01** (Etui)

Wundhaken
Retractors
Separadores
Divaricatori



Dura- und Hauthäkchen
Dura and Skin Retractors
Gancho para piel y dura-madre
Unico per pelle e dura-madre

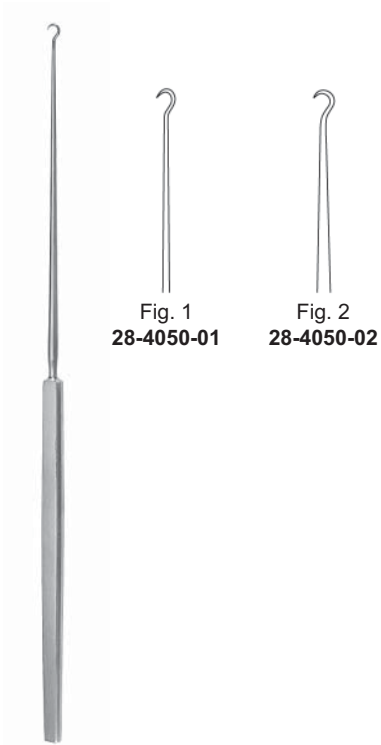

GILLIES
 18,0 cm, 7"



KILNER
 15,0 cm, 6"
 28-4054-15



FRAZIER
 13,0 cm, 5"
 28-4060-13



O'CONNOR
 16,0 cm, 6 1/4"
 28-4074-16

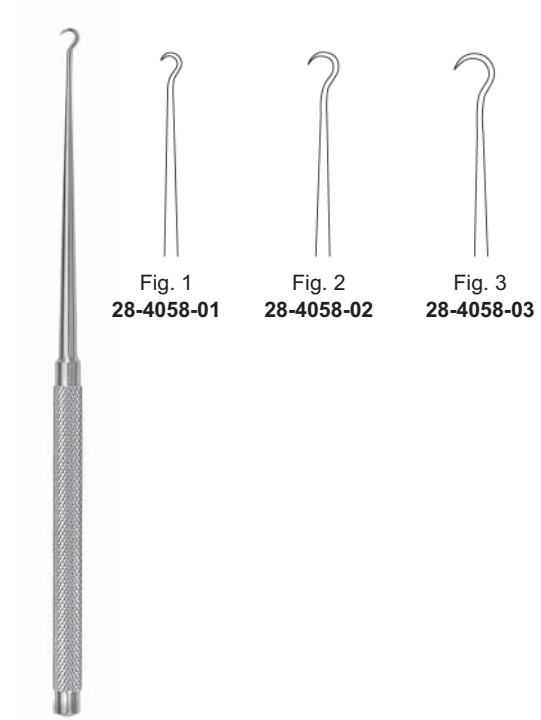

KLEINERT-KUTZ
 16,0 cm, 6 1/4"



JOSEPH
 16,0 cm, 6 1/4"
 28-4062-16



GRAEFE
 16,0 cm, 6 1/4"



Dura- und Hauthäkchen
Dura and Skin Retractors
Gancho para piel y dura-madre
Unico per pelle e dura-madre

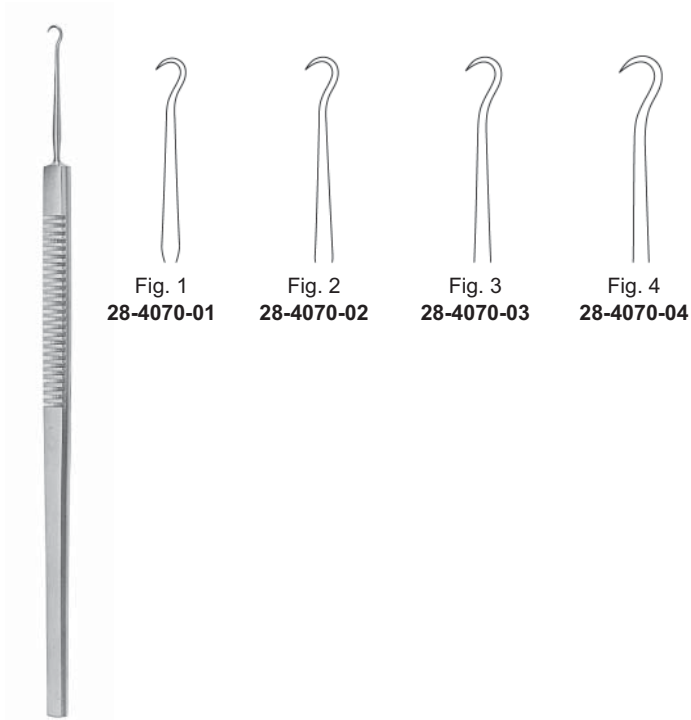

Fig. 1
28-4070-01

Fig. 2
28-4070-02

Fig. 3
28-4070-03

Fig. 4
28-4070-04

16,0 cm, 6 1/4"

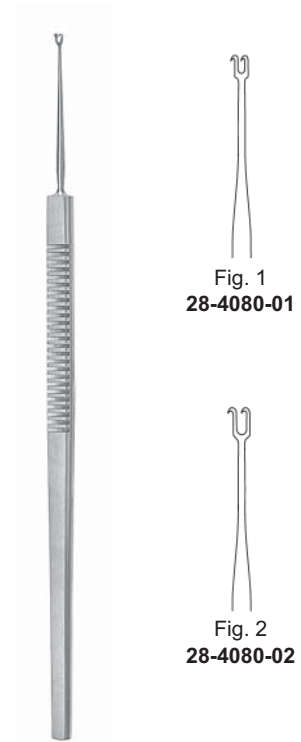

Fig. 1
28-4080-01

Fig. 2
28-4080-02

GUTHRIE
 16,0 cm, 6 1/4"

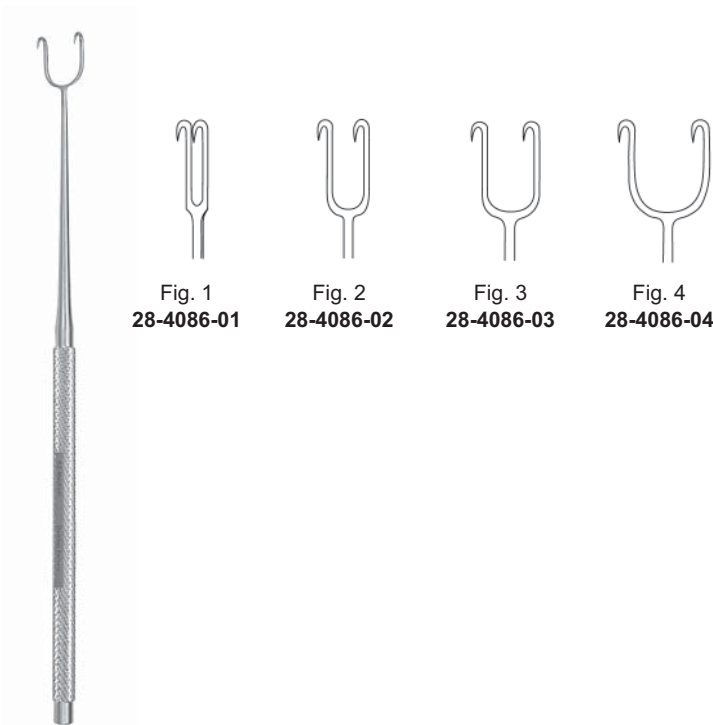

Fig. 1
28-4086-01

Fig. 2
28-4086-02

Fig. 3
28-4086-03

Fig. 4
28-4086-04

JOSEPH
 16,0 cm, 6 1/4"

Wundhaken
Retractors
Separadores
Divaricatori



Fig. 1
28-4082-01

scharf
sharp
agudos
acuti



Fig. 2
28-4082-02

stumpf
blunt
romo
smusso



28-4088-02



28-4089-02



28-4088-03

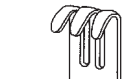

28-4089-03



28-4088-04

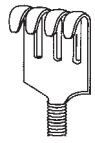

28-4089-04

flexibel · flexible · flexibles · flessibili

KNAPP
13,0 cm, 5"

16,0 cm, 6 1/4"



28-4101-01



28-4101-02



28-4101-03



28-4101-04

scharf
sharp
agudos
acuti



28-4103-01



28-4103-02



28-4103-03



28-4103-04

halbscharf
semi-sharp
semi-agudos
semi-acuti



28-4102-01



28-4102-02



28-4102-03



28-4102-04

stumpf
blunt
romo
smusso

16,0 cm, 6 1/4"

**Wundhaken
Retractors
Separadores
Divaricatori**

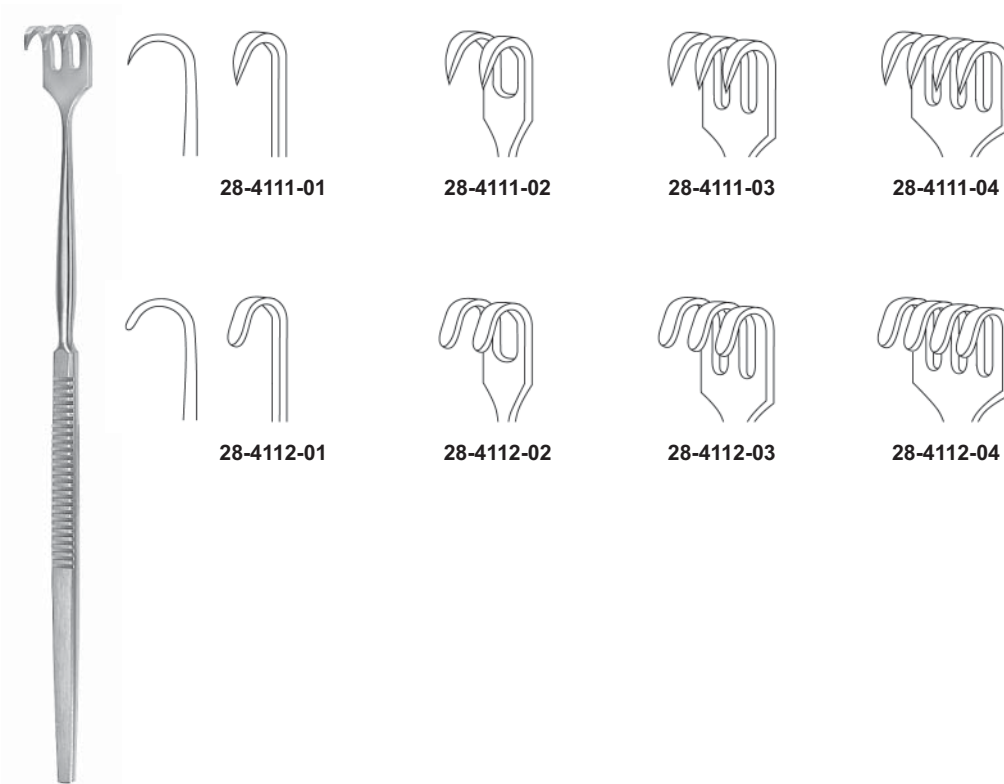

scharf
sharp
agudos
acuti

stumpf
blunt
romo
smusso

16,0 cm, 6¹/₄"

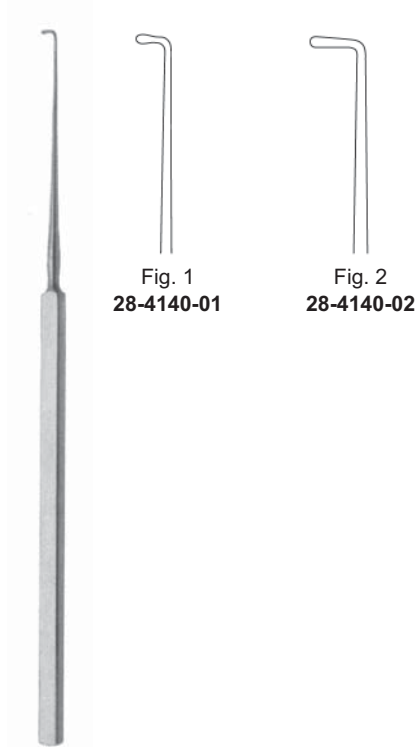

CUSHING
19,0 cm, 7¹/₂"

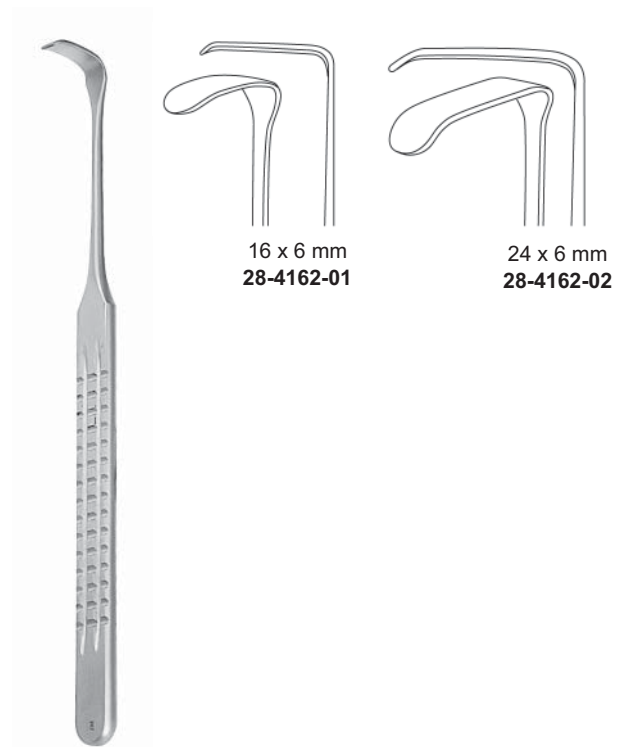

LANGENBECK-GREEN
16,0 cm, 6¹/₄"

**Wundhaken
Retractors
Separadores
Divaricatori**



MEYERDING
18,0 cm, 7"



18 x 7 mm
28-4150-01



16 x 5 mm
28-4150-02



7 x 4 mm
28-4150-03



10 x 3 mm
28-4150-04



7 x 4 mm
28-4150-05



4 x 10 mm
28-4150-06



16,0 cm, 6 1/4"



14 x 8 mm
28-4166-16



SENN-GREEN
15,0 cm, 6"



10 x 6 mm
28-4160-10

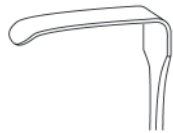

20 x 6 mm
28-4160-20



MINI-LANGENBECK
16,0 cm, 6 1/4"



10 x 6 mm
28-4164-01



17 x 5 mm
28-4164-02



20 x 6 mm
28-4164-03



22 x 8 mm
28-4164-04



RAGNELL-DAVIS
 14,0 cm, 5½"
 28-4170-14



RAGNELL
 15,0 cm, 6"
 28-4174-15

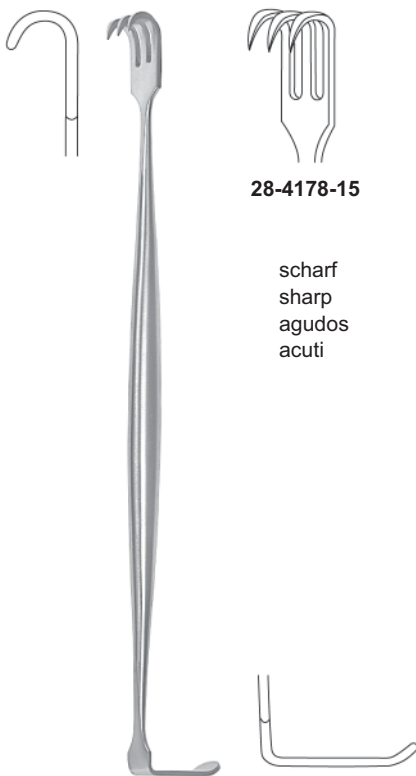

BABY SENN-MILLER
 15,0 cm, 6"

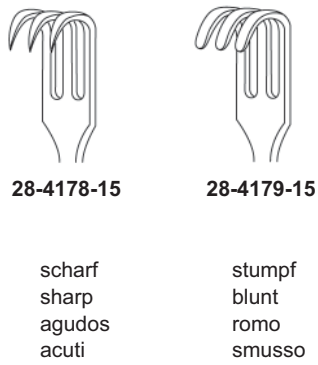

28-4178-15

scharf
 sharp
 agudos
 acuti



28-4179-15

stumpf
 blunt
 romo
 smusso

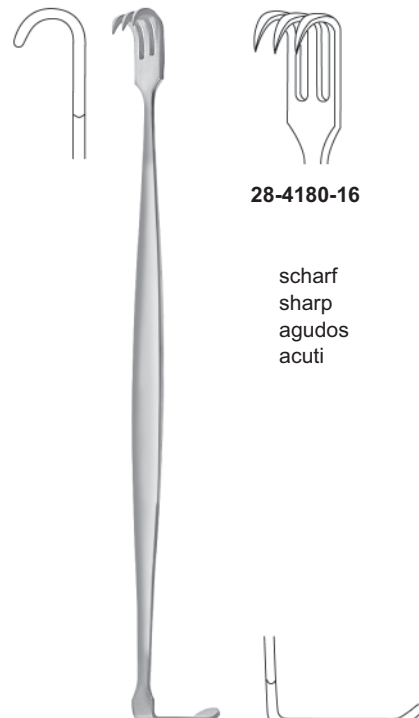

SENN-MILLER
 16,0 cm, 6¼"

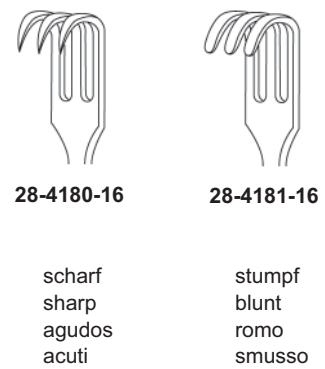

28-4180-16

scharf
 sharp
 agudos
 acuti

28-4181-16

stumpf
 blunt
 romo
 smusso

**Wundhaken
Retractors
Separadores
Divaricatori**

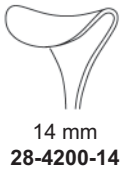

DESMARRES
13,0 cm, 5"

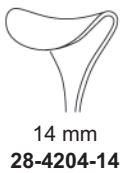
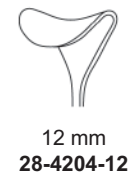

DESMARRES
16,0 cm, 6 1/4"



8 mm
28-4210-08



10 mm
28-4210-10



12 mm
28-4210-12



14 mm
28-4210-14



16 mm
28-4210-16



18 mm
28-4210-18

CUSHING
20,0 cm, 8"



8 mm
28-4212-08



10 mm
28-4212-10



12 mm
28-4212-12



14 mm
28-4212-14



16 mm
28-4212-16



18 mm
28-4212-18

CUSHING
24,0 cm, 9 1/2"

Wundhaken
Retractors
Separadores
Divaricatori



8 mm
28-4220-08



11 mm
28-4220-11



13 mm
28-4220-13



17 mm
28-4220-17



20 mm
28-4220-20



23 mm
28-4220-23

GIL-VERNET
24,0 cm, 9½"



8 mm
28-4230-08



11 mm
28-4230-11



13 mm
28-4230-13



17 mm
28-4230-17



20 mm
28-4230-20



23 mm
28-4230-23

GIL-VERNET
24,0 cm, 9½"



Fig. 1 24 x 20 mm
Fig. 2 29 x 26 mm
Fig. 3 33 x 29 mm
Fig. 4 29 x 24 mm

Satz, Fig. 1-3
Set, fig. 1-3
Juego, fig. 1-3
Serie, fig. 1-3

Fig. 1 30 x 28 mm
Fig. 2 36 x 36 mm
Fig. 3 38 x 43 mm
Fig. 4 45 x 28 mm

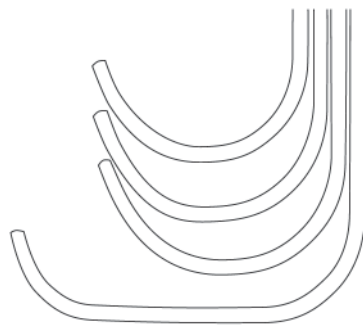
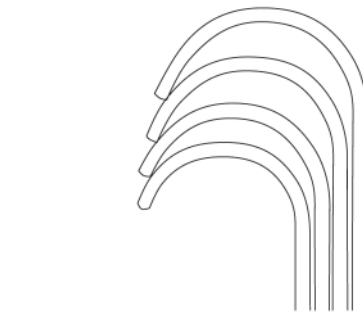

Fig. 1-3	17,0 cm, 6 ³ / ₄ "	28-4310-00
Fig. 1	14,0 cm, 5 ¹ / ₂ "	28-4310-01
Fig. 2	15,0 cm, 6"	28-4310-02
Fig. 3	17,0 cm, 6 ³ / ₄ "	28-4310-03
Fig. 4	18,0 cm, 7"	28-4310-04

ROUX



Fig. 2 30 x 10 mm
Fig. 1 26 x 10 mm

Fig. 1 30 x 13 mm
Fig. 2 34 x 13 mm

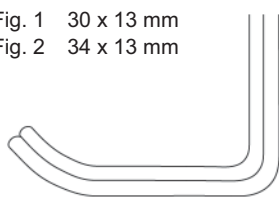
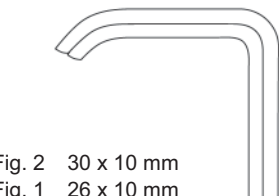

FARABEUF
12,0 cm, 4³/₄"
28-4300-12



Fig. 2 23 x 16 mm
Fig. 1 27 x 16 mm

Fig. 1 26 x 16 mm
Fig. 2 30 x 16 mm

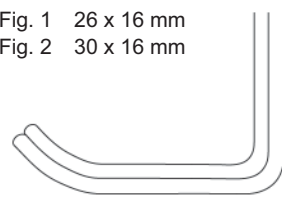
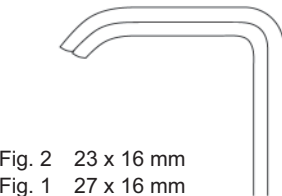

FARABEUF
15,0 cm, 5³/₄"
28-4302-15

Wundhaken
Retractors
Separadores
Divaricatori



MINI-ROUX
14,0 cm, 5½"
28-4340-06



BABY-ROUX
13,0 cm, 5"
28-4342-13

18 x 17 mm

24 x 21 mm



PARKER
13,5 cm, 5⅜"
28-4350-00

Fig. 2 22 x 15 mm
Fig. 1 19 x 15 mm

Fig. 1 19 x 15 mm
Fig. 2 22 x 15 mm

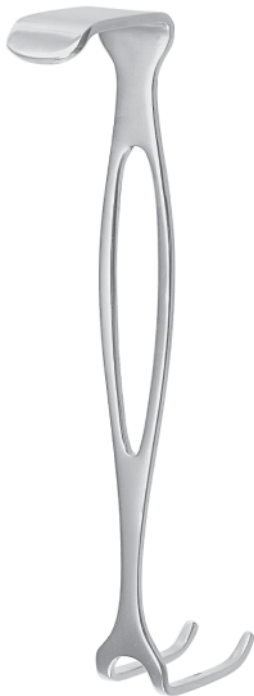

CZERNY
17,5 cm, 7"
28-4360-00

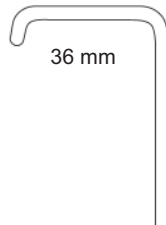

36 mm



38 x 42 mm



MATHIEU
20,0 cm, 8"
28-4380-00

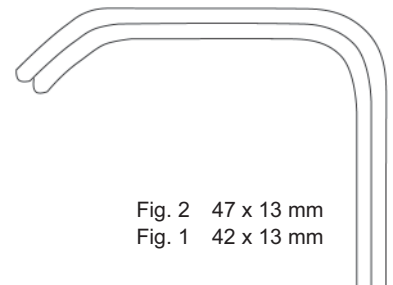

Fig. 2 47 x 13 mm
Fig. 1 42 x 13 mm

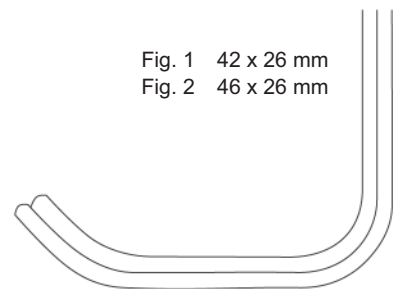

Fig. 1 42 x 26 mm
Fig. 2 46 x 26 mm

**Wundhaken
Retractors
Separadores
Divaricatori**



GOELET
19,0 cm, 7½"
28-4396-19



PARKER-LANGENBECK
21,0 cm, 8¼"
28-4390-00

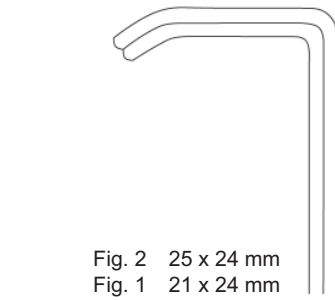

Fig. 2 25 x 24 mm
Fig. 1 21 x 24 mm

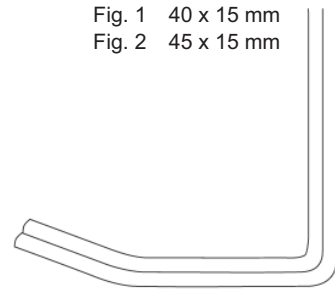

Fig. 1 40 x 15 mm
Fig. 2 45 x 15 mm



CANNY RYAL

16 mm	19,0 cm, 7½"	28-4370-16
20 mm	19,0 cm, 7½"	28-4370-20
25 mm	20,0 cm, 8"	28-4370-25

**Wundhaken
Retractors
Separadores
Divaricatori**



VOLKMANN
21,5 cm, 8½"



29-4001-01



9 x 8 mm
29-4001-02



9 x 13 mm
29-4001-03



9 x 19 mm
29-4001-04

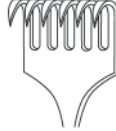

9 x 29 mm
29-4001-06

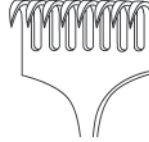

9 x 40 mm
29-4001-08

scharf
sharp
agudos
acuti



VOLKMANN
21,5 cm, 8½"



29-4003-01



9 x 8 mm
29-4003-02



9 x 13 mm
29-4003-03



9 x 19 mm
29-4003-04

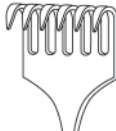

9 x 29 mm
29-4003-06

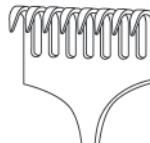

9 x 40 mm
29-4003-08

halbscharf
semi-sharp
semi-agudos
semi-acuti



VOLKMANN
21,5 cm, 8½"



29-4002-01



9 x 8 mm
29-4002-02



9 x 13 mm
29-4002-03



9 x 19 mm
29-4002-04

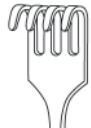

9 x 29 mm
29-4002-06

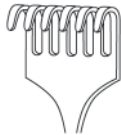

9 x 40 mm
29-4002-08

stumpf
blunt
romo
smusso



KOCHER
22,0 cm, 8⅝"



29-4011-01



9 x 8 mm
29-4011-02



15 x 15 mm
29-4011-03



15 x 20 mm
29-4011-04



15 x 30 mm
29-4011-06



15 x 40 mm
29-4011-08

scharf
sharp
agudos
acuti

**Wundhaken
Retractors
Separadores
Divaricatori**



KOCHER
22,0 cm, 8⁵/₈"

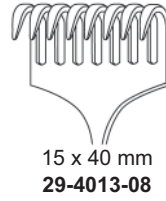
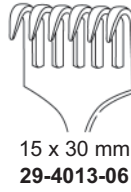
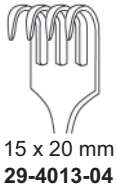
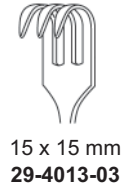
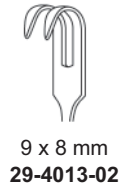

halbscharf
semi-sharp
semi-agudos
semi-acuti



KOCHER
22,0 cm, 8⁵/₈"

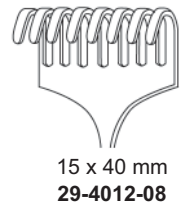
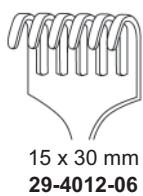
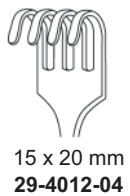
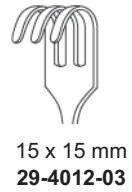
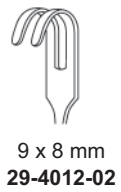

stumpf
blunt
romo
smusso

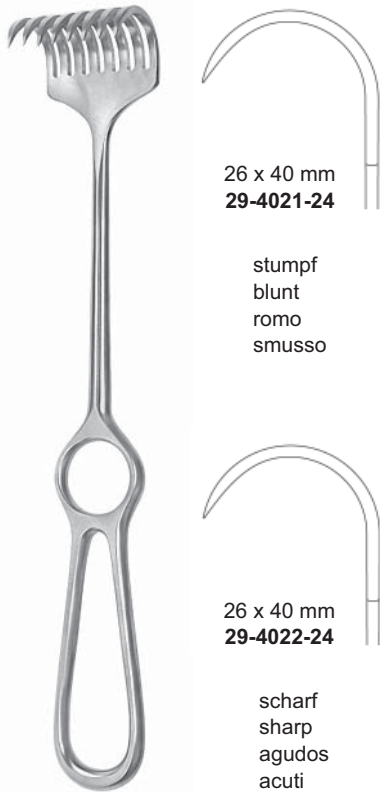

26 x 40 mm
29-4021-24

stumpf
blunt
romo
smusso

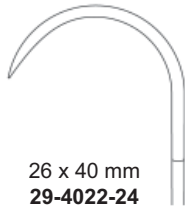

26 x 40 mm
29-4022-24

scharf
sharp
agudos
acuti

KOERTE
24,0 cm, 9 1/2"

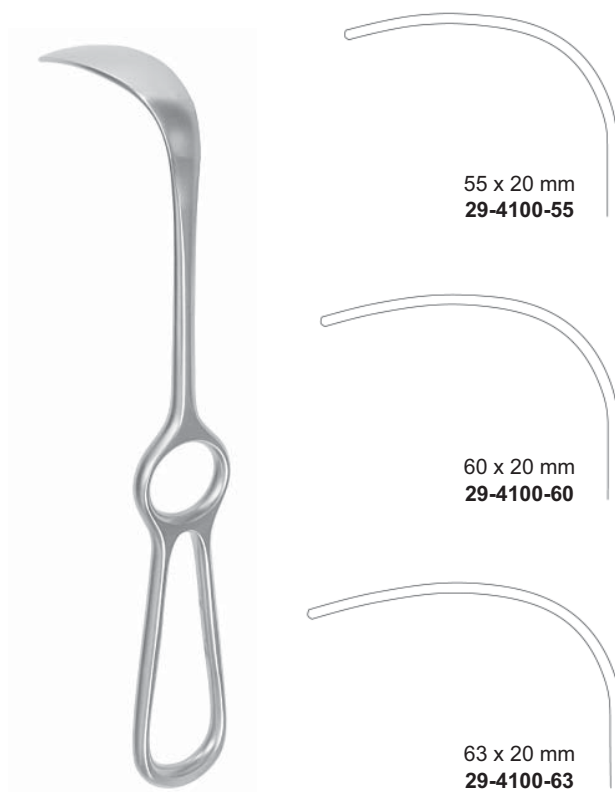

55 x 20 mm
29-4100-55

60 x 20 mm
29-4100-60

63 x 20 mm
29-4100-63

LANGENBECK
21,0 cm, 8 1/4"



ISRAEL
25,0 cm, 9 3/4"

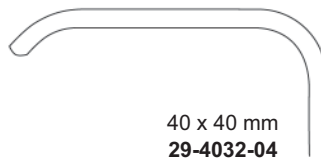

40 x 40 mm
29-4032-04

4 Zähne
4 teeth
4 dientes
4 denti

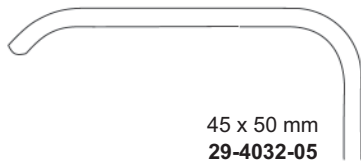

45 x 50 mm
29-4032-05

5 Zähne
5 teeth
5 dientes
5 denti

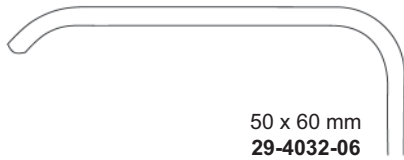

50 x 60 mm
29-4032-06

6 Zähne
6 teeth
6 dientes
6 denti



70 x 70 mm
29-4032-07

6 Zähne
6 teeth
6 dientes
6 denti

**Wundhaken
Retractors
Separadores
Divaricatori**



LANGENBECK
22,0 cm, 8⁵/₈"



30 x 11 mm
29-4110-30



30 x 14 mm
29-4110-31



30 x 16 mm
29-4110-32



40 x 11 mm
29-4110-40



50 x 11 mm
29-4110-50



LANGENBECK
22,0 cm, 8⁵/₈"



30 x 11 mm
29-4120-30



30 x 14 mm
29-4120-31



30 x 16 mm
29-4120-32













40 x 11 mm
29-4120-40



50 x 11 mm
29-4120-50



KOCHER-LANGENBECK
21,5 cm, 8½"

	22 x 6 mm 29-4130-22
	25 x 6 mm 29-4130-25
	25 x 8 mm 29-4130-26
	35 x 8 mm 29-4130-35
	35 x 11 mm 29-4130-36
	35 x 15 mm 29-4130-37
	40 x 11 mm 29-4130-40
	70 x 14 mm 29-4130-70
	80 x 12 mm 29-4130-80
	80 x 16 mm 29-4130-85

**Wundhaken
Retractors
Separadores
Divaricatori**



KOCHER
23,0 cm, 9"

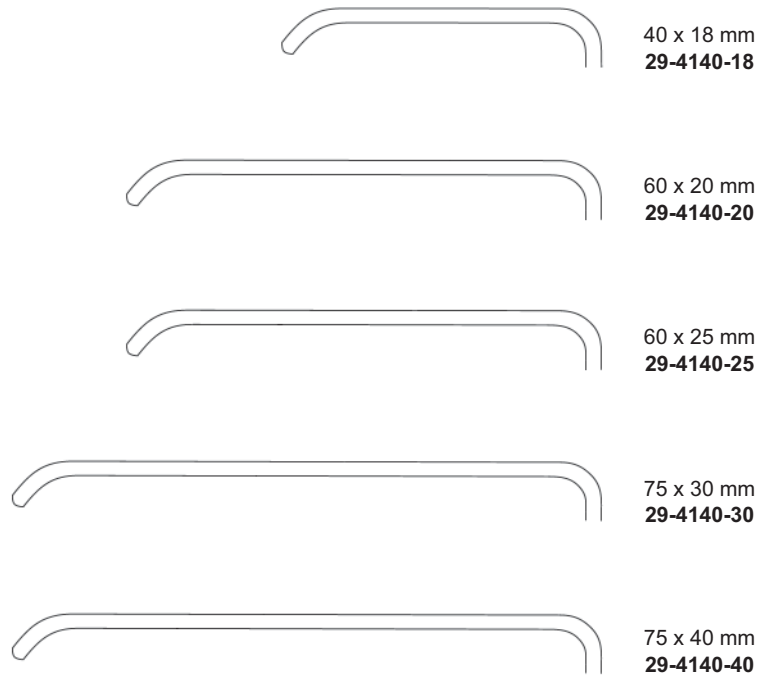

SAUERBRUCH
22,5 cm, 8³/₄"

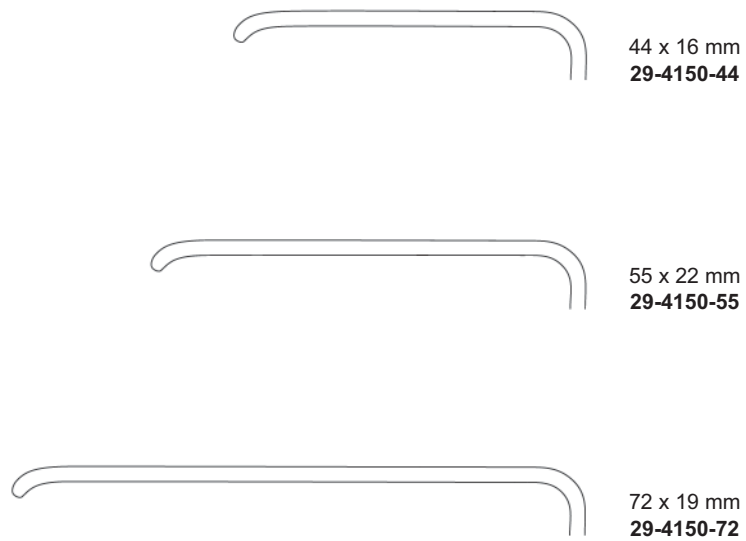



MIDDELDORPF



MIDDELDORPF



RICHARDSON (KELLY)
24,0 cm, 9¹/₂"

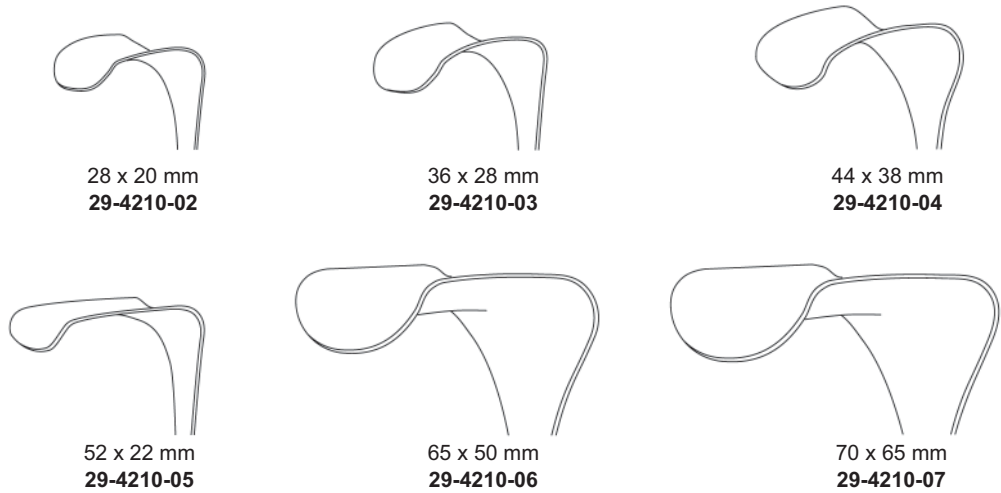

**Wundhaken
Retractors
Separadores
Divaricatori**

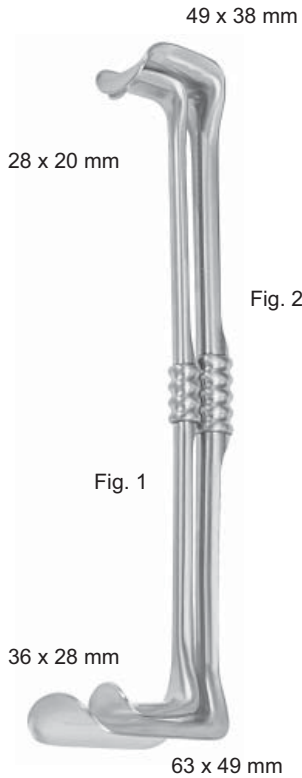
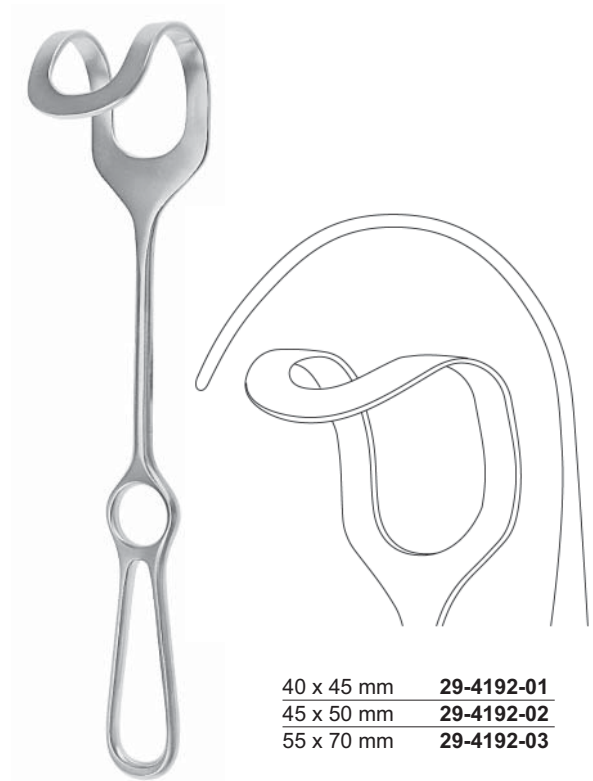

Fig. 1+2	28,0 cm, 11"	28-4200-00
Fig. 1	26,0 cm, 10 ¹ / ₄ "	28-4200-01
Fig. 2	28,0 cm, 11"	28-4200-02

RICHARDSON-EASTMAN



MIDDELDORPF
25,5 cm, 10"



FRITSCH
24,0 cm, 9¹/₂"



DOYEN
25,0 cm, 10"
29-4230-50



DOYEN-STILLE
22,0 cm, 8⁵/₈"

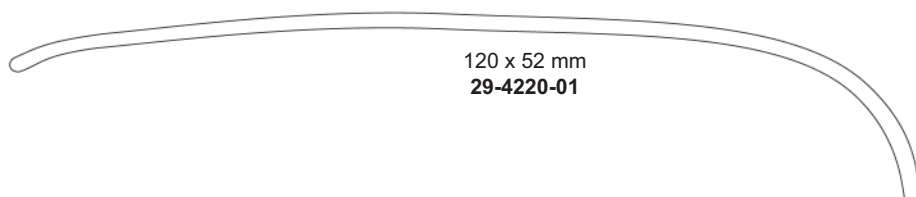

120 x 52 mm
29-4220-01

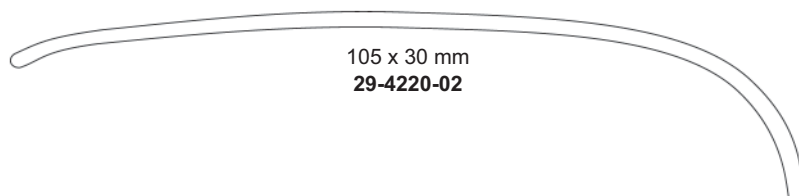

105 x 30 mm
29-4220-02

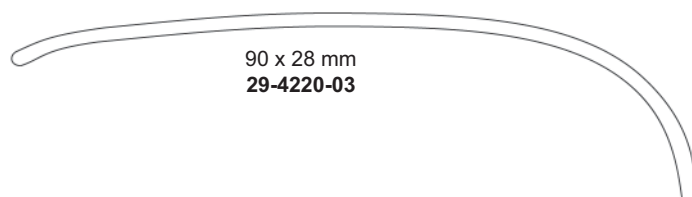

90 x 28 mm
29-4220-03

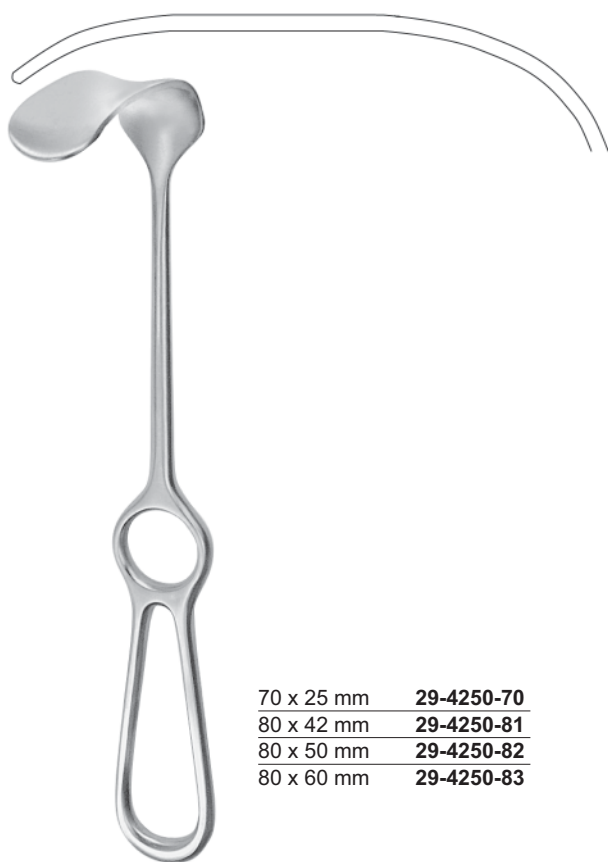

KOCHER
25,0 cm, 10"

- | | |
|------------|-------------------|
| 70 x 25 mm | 29-4250-70 |
| 80 x 42 mm | 29-4250-81 |
| 80 x 50 mm | 29-4250-82 |
| 80 x 60 mm | 29-4250-83 |



LAHEY
19,0 cm, 7¹/₂"
29-4160-19

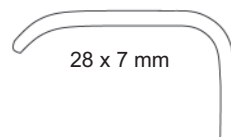

28 x 7 mm

**Wundhaken
Retractors
Separadores
Divaricatori**



12 x 13 mm



LITTLE
20,0 cm, 8"
29-4164-20



115 x 22 mm **29-4260-01**
115 x 27 mm **29-4260-02**

SIMON
28,0 cm, 11"



160 x 38 mm **29-4280-61**
160 x 57 mm **29-4280-62**
190 x 38 mm **29-4280-91**
190 x 57 mm **29-4280-92**

KELLY
27,0 cm, 10 1/2"



85 x 35 mm	29-4274-01
120 x 50 mm	29-4274-02
150 x 50 mm	29-4274-03

MIKULICZ
26,0 cm, 10¹/₄"



90 x 50 mm

MIKULICZ
26,0 cm, 10¹/₄"
29-4272-90



70 x 38 mm	29-4290-38
70 x 50 mm	29-4290-51

MORRIS
24,5 cm, 9⁵/₈"

**Wundhaken
Retractors
Separadores
Divaricatori**

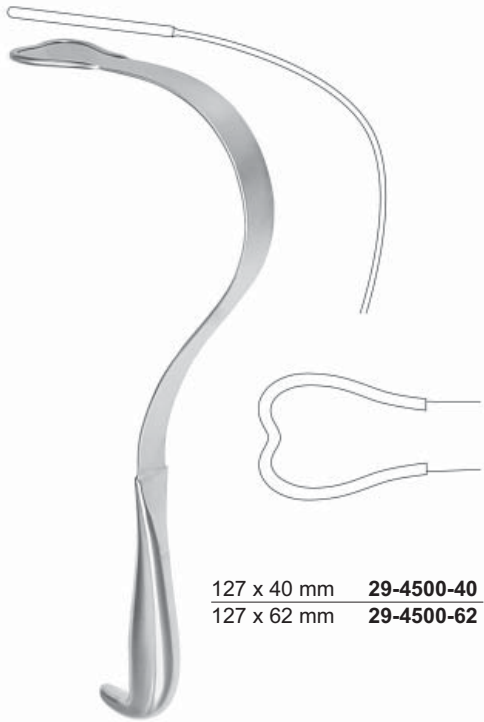

127 x 40 mm **29-4500-40**
127 x 62 mm **29-4500-62**

HARRINGTON
32,0 cm, 12¹/₂"



82 x 22 mm **29-4390-01**
108 x 43 mm **29-4390-02**
115 x 65 mm **29-4390-03**

CORYKKOS
24,0 cm, 9¹/₂"



ZENKER

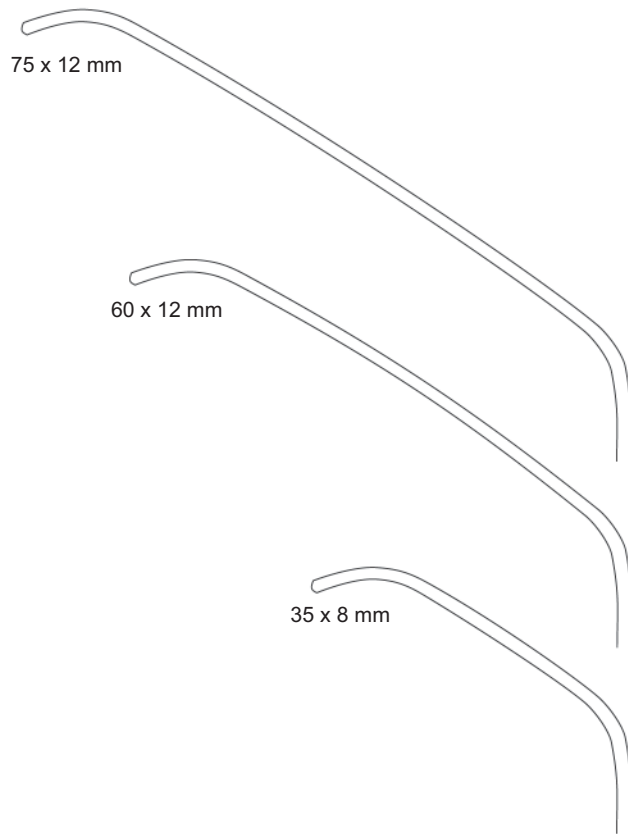

75 x 12 mm

60 x 12 mm

35 x 8 mm

25,0 cm, 9³/₄"
29-4320-25

26,0 cm, 10¹/₄"
29-4320-26

27,5 cm, 10³/₄"
29-4320-27



MEYERDING
22,5 cm, 8¾"

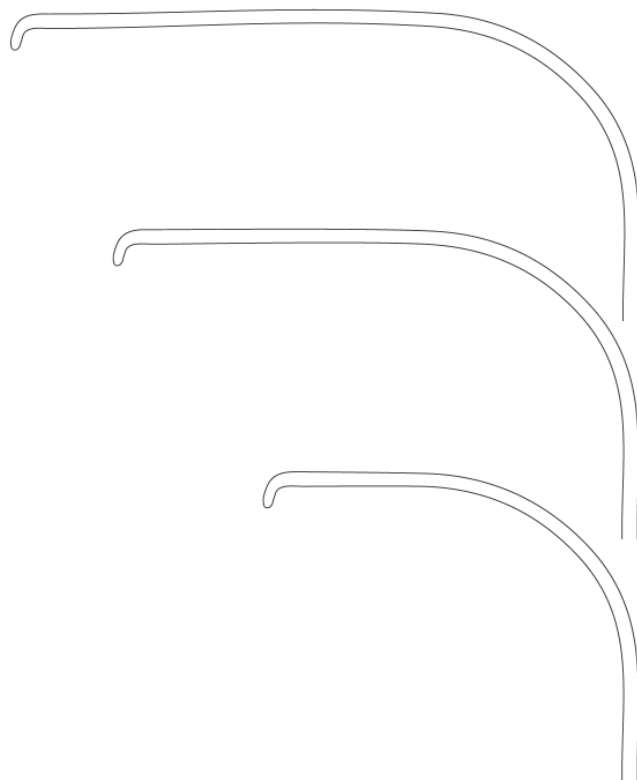

90 x 50 mm
29-4350-50

75 x 25 mm
29-4350-25

50 x 16 mm
29-4350-16



BRUNNER
25,0 cm, 10"

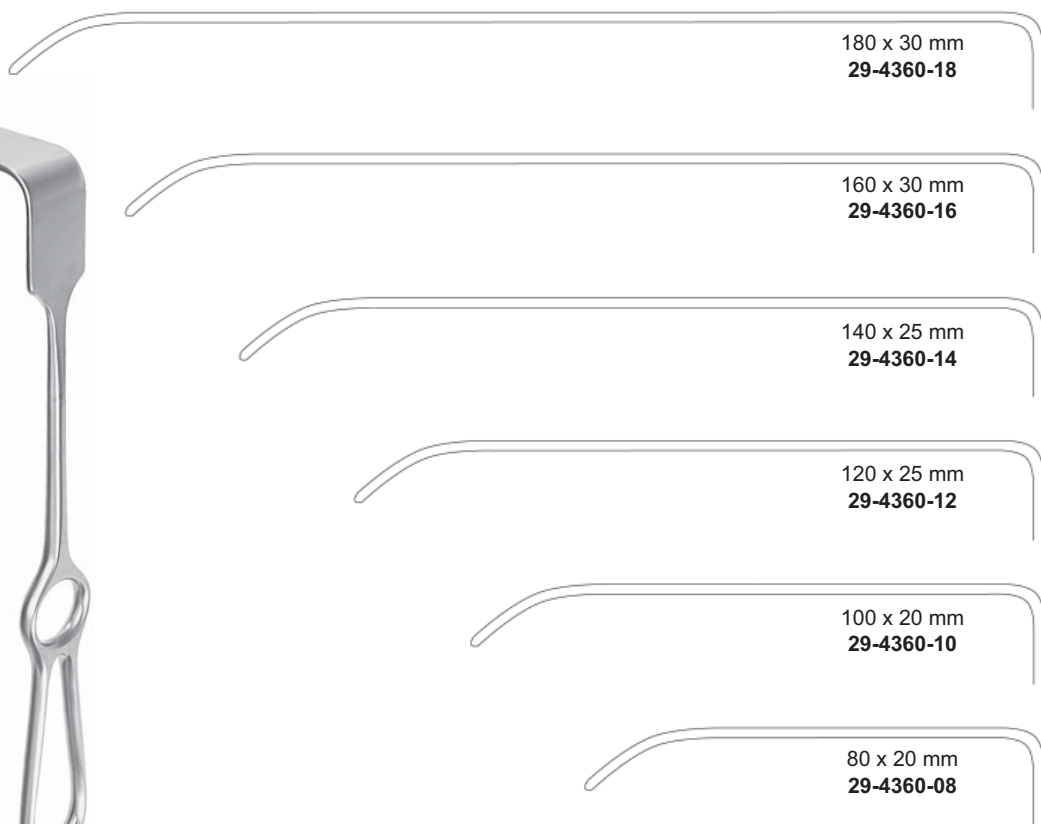

180 x 30 mm
29-4360-18

160 x 30 mm
29-4360-16

140 x 25 mm
29-4360-14

120 x 25 mm
29-4360-12

100 x 20 mm
29-4360-10

80 x 20 mm
29-4360-08

Wundhaken
 Retractors
 Separadores
 Divaricatori



BRUNNER
 25,0 cm, 10"

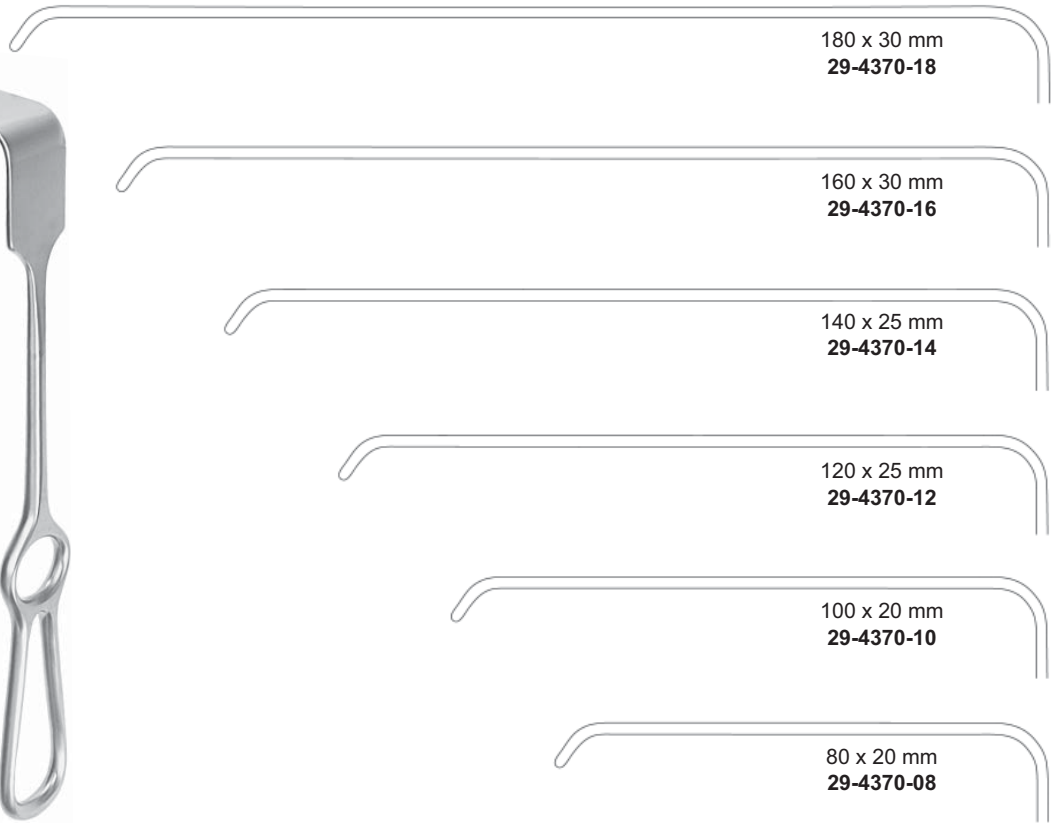

180 x 30 mm
 29-4370-18

160 x 30 mm
 29-4370-16

140 x 25 mm
 29-4370-14

120 x 25 mm
 29-4370-12

100 x 20 mm
 29-4370-10

80 x 20 mm
 29-4370-08



19 mm

DEAVER
 18,0 cm, 7"
 29-4602-18



22 mm

DEAVER
 21,5 cm, 8 1/2"
 29-4602-22



25 mm

DEAVER
 23,0 cm, 9"
 29-4602-23



DEAVER
30,0 cm, 11³/₄"
29-4604-30



DEAVER
33,0 cm, 13"
29-4604-33



DEAVER
36,0 cm, 14¹/₈"
29-4604-36



DEAVER
30,0 cm, 11³/₄"
29-4610-38



DEAVER
30,0 cm, 11³/₄"
29-4610-50



DEAVER
30,0 cm, 11³/₄"
29-4610-75

**Wundhaken
Retractors
Separadores
Divaricatori**

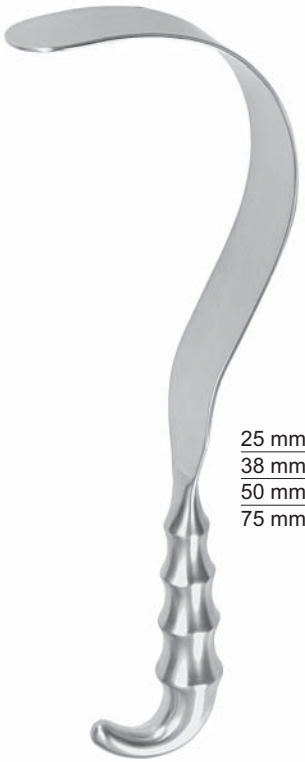

25 mm **29-4600-25**
 38 mm **29-4600-38**
 50 mm **29-4600-50**
 75 mm **29-4600-75**

DEAVER
 30,0 cm, 11³/₄"



ALLISON

40 mm 30,0 cm, 11³/₄" **29-4700-30**
 54 mm 32,0 cm, 12¹/₂" **29-4700-32**



DAVIDSON

75 x 50 mm 16,0 cm, 6¹/₄" **29-4710-50**
 75 x 90 mm 16,0 cm, 6¹/₄" **29-4710-90**



ST MARKS

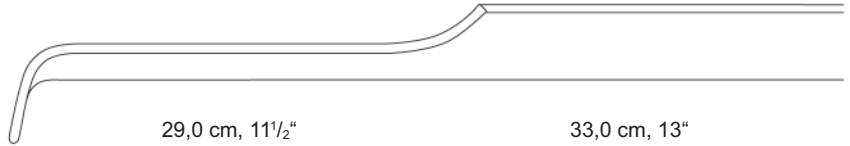

29,0 cm, 11¹/₂"
 130 x 60 mm
29-4720-01

33,0 cm, 13"
 180 x 60 mm
29-4720-02

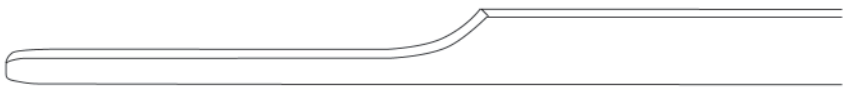

29,0 cm, 11¹/₂"
 130 x 60 mm
29-4721-01

33,0 cm, 13"
 180 x 60 mm
29-4721-02

Wundspreizer
Self-Retaining Retractors
Separadores con retenida automática
Divaricatori autostatici



Wundspreizer
Self-Retaining Retractors
Separadores con retenida automática
Divaricatori autostatici

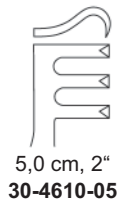

5,0 cm, 2"
30-4610-05



5,0 cm, 2"
30-4611-05

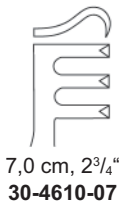

7,0 cm, 2³/₄"
30-4610-07

scharf
 sharp
 agudos
 acuti



7,0 cm, 2³/₄"
30-4611-07

stumpf
 blunt
 romo
 smusso



FINSEN



JANSEN
 10,0 cm, 4"

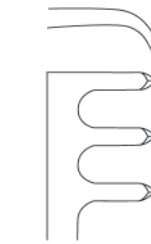

30-4630-10

scharf
 sharp
 agudos
 acuti

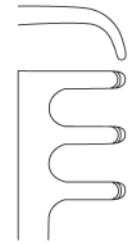

30-4631-10

stumpf
 blunt
 romo
 smusso



ALM

scharf
 sharp
 agudos
 acuti

halbscharf
 semi-sharp
 semi-agudos
 semi-acuti

stumpf
 blunt
 romo
 smusso



7,0 cm, 2³/₄"
 10,0 cm, 4"

30-4620-07
30-4620-10



30-4622-07
30-4622-10



30-4621-07
30-4621-10



ALLPORT
 9,5 cm, 3³/₄"
30-4626-09

Wundspreizer
Self-Retaining Retractors
Separadores con retenida automática
Divaricatori autostatici



30-4660-14
 scharf
 sharp
 agudos
 acuti

30-4661-14
 stumpf
 blunt
 romo
 smusso

SALP-CONTOUR
 14,0 cm, 5½"



30-4684-16
 scharf
 sharp
 agudos
 acuti

30-4685-16
 stumpf
 blunt
 romo
 smusso

ADSON-BABY
 16,0 cm, 6¼"



30-4678-20
 stumpf
 blunt
 romo
 smusso

30-4679-20
 scharf
 sharp
 agudos
 acuti

ANDERSON-ADSON
 19,0 cm, 8"



30-4682-26
 scharf
 sharp
 agudos
 acuti

30-4683-26
 stumpf
 blunt
 romo
 smusso

ADSON
 26,5 cm, 10½"

Wundspreizer
Self-Retaining Retractors
Separadores con retenida automática
Divaricatori autostatici



MOLLISON
 15,5 cm, 6"
 30-4674-15



scharf
 sharp
 agudos
 acuti



SCHUHKNECHT
 12,5 cm, 5"



30-4800-12
 scharf
 sharp
 agudos
 acuti



30-4801-12
 stumpf
 blunt
 romo
 smusso



WULLSTEIN



scharf	stumpf
sharp	blunt
agudos	romo
acuti	smusso

10,5 cm, 4 ¹ / ₈ "	30-4810-10	30-4811-10
13,0 cm, 5"	30-4810-13	30-4811-13
15,0 cm, 6"	30-4810-15	30-4811-15
18,0 cm, 7"	30-4810-18	30-4811-18



MAYO-ADAMS
 16,5 cm, 6¹/₂"
 30-4822-17

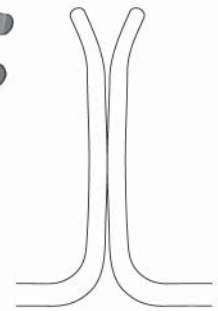

Wundspreizer
Self-Retaining Retractors
Separadores con retenida automática
Divaricatori autostatici



WEITLANER-LOKTITE
 10,5 cm, 4 1/8"



30-4650-10

scharf
 sharp
 agudos
 acuti



30-4651-10

stumpf
 blunt
 romo
 smusso



WEITLANER
 13,0 cm, 5"



30-4670-13

scharf
 sharp
 agudos
 acuti



30-4671-13

stumpf
 blunt
 romo
 smusso



WEITLANER
 16,5 cm, 6 1/2"



30-4670-16

scharf
 sharp
 agudos
 acuti



30-4671-16

stumpf
 blunt
 romo
 smusso



WEITLANER
 20,0 cm, 8"



30-4670-20

scharf
 sharp
 agudos
 acuti



30-4671-20

stumpf
 blunt
 romo
 smusso

Wundspreizer
Self-Retaining Retractors
Separadores con retenida automática
Divaricatori autostatici



WEITLANER
 24,0 cm, 9½"



30-4670-24
 scharf
 sharp
 agudos
 acuti



30-4671-24
 stumpf
 blunt
 romo
 smusso



PLESTER
 13,0 cm, 5"



30-4830-13
 scharf
 sharp
 agudos
 acuti



30-4831-13
 stumpf
 blunt
 romo
 smusso



MILLIGAN
 13,0 cm, 5"
30-4840-13

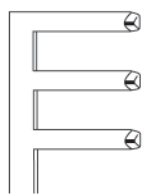

PLESTER
 11,0 cm, 4¾"
30-4672-11

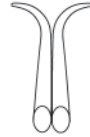

PLESTER
 11,0 cm, 4¾"
30-4673-11

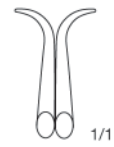

Wundspreizer
Self-Retaining Retractors
Separadores con retenida automática
Divaricatori autostatici



WEITLANER-BABY
 13,0 cm, 5"
 30-4850-13



ADSON
(CONE)

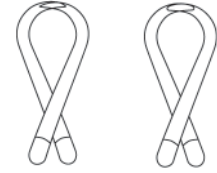

20,0 cm, 8"	30-4860-20	30-4861-20
26,0 cm, 10 ¹ / ₄ "	30-4860-26	30-4861-26

scharf	stumpf
sharp	blunt
agudos	romo
acuti	smusso



GELPI
 13,5 cm, 5³/₈"
 30-4202-14



GELPI
 19,0 cm, 7¹/₂"
 30-4202-19



GELPI-LOKTITE
 18,0 cm, 7¹/₂"
 30-4250-19

Wundspreizer
 Self-Retaining Retractors
 Separadores con retenida automática
 Divaricatori autostatici

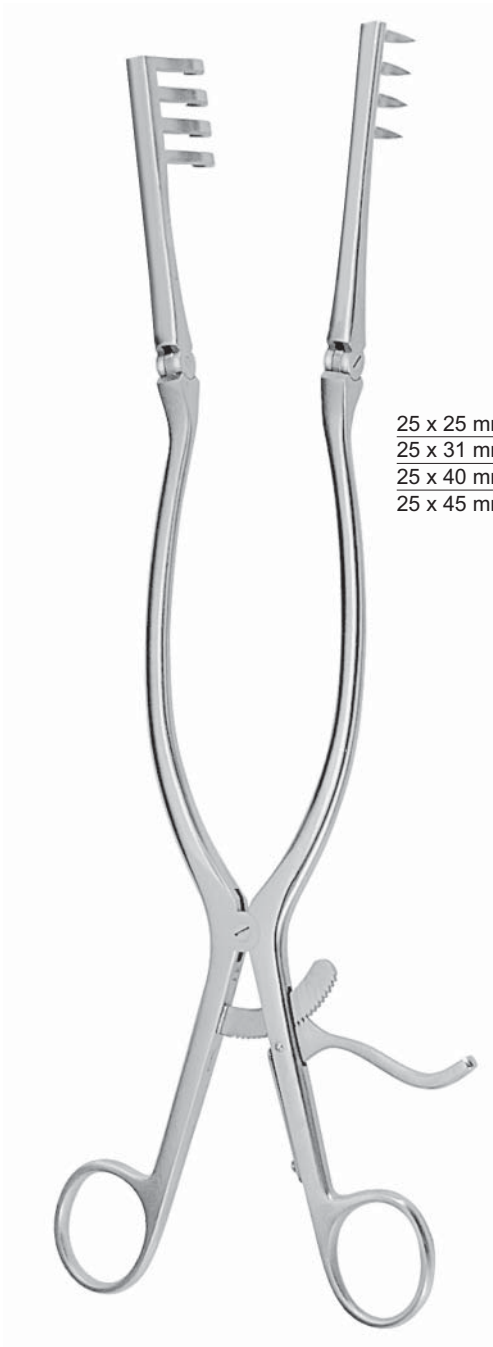

BECKMANN-ADSON
 31,0 cm, 12 1/4"

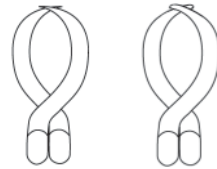

25 x 25 mm	30-4870-01	30-4871-01
25 x 31 mm	30-4870-02	30-4871-02
25 x 40 mm	30-4870-03	30-4871-03
25 x 45 mm	30-4870-04	30-4871-04

scharf	stumpf
sharp	blunt
agudos	romo
acuti	smusso

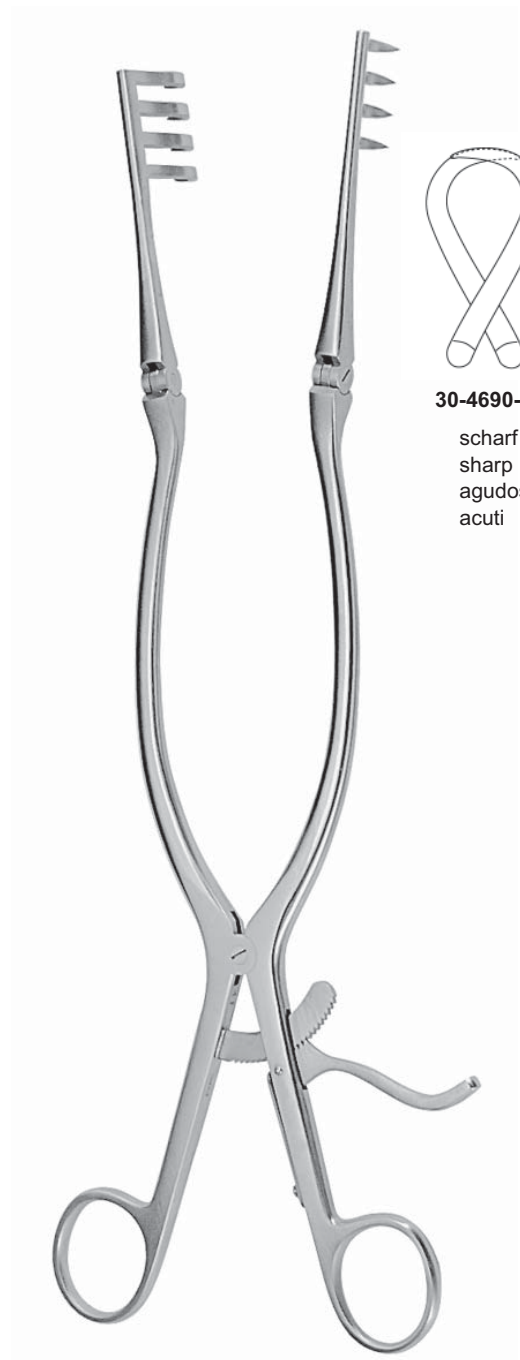

BECKMANN
 31,0 cm, 12 1/4"



30-4690-31

scharf
 sharp
 agudos
 acuti



BECKMANN
32,0 cm, 12½"



30-4691-32

stumpf
blunt
romo
smusso



10,0 cm, 4" **30-4240-10**
14,0 cm, 5½" **30-4240-14**

DE BAKEY

Wundspreizer
Self-Retaining Retractors
Separadores con retenida automática
Divaricatori autostatici



NORFOLK AND NORWICH
 22,0 cm, 8⁵/₈"
 30-4401-22



stumpf
 blunt
 romo
 smusso



JACKSON BURROWS
 17,5 cm, 7"
 30-4411-17

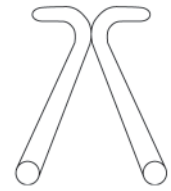

stumpf
 blunt
 romo
 smusso



RICHTER
 17,0 cm, 6³/₄"
 30-4420-17



JOLL (FRIEDMAN)
 15,5 cm, 6"
 30-4430-15

**Wundspreizer
Self-Retaining Retractors
Separadores con retenida automática
Divaricatori autostatici**

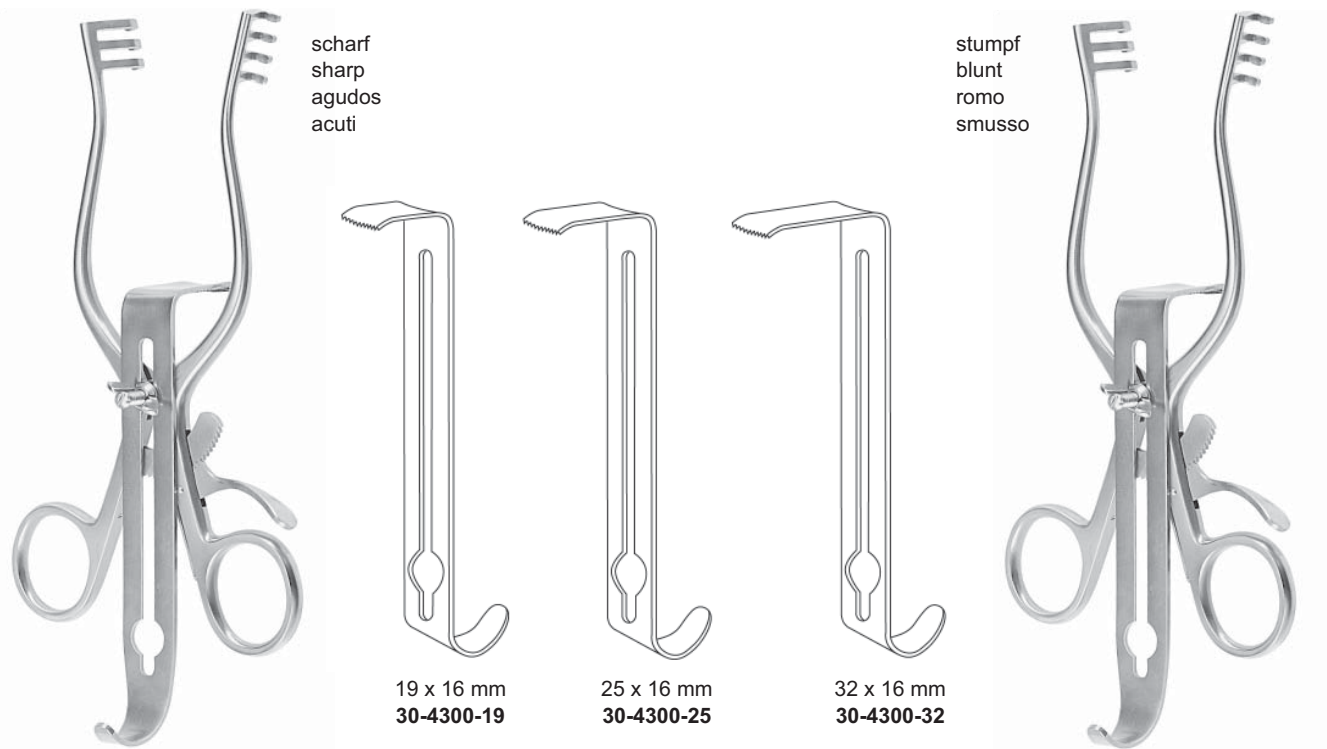

HENLEY
16,0 cm, 6¹/₄"
30-4300-16

HENLEY
16,0 cm, 6¹/₄"
30-4301-16

**HENLEY
30-4300-00**

komplett, bestehend aus:

- 1 Sperrer mit Seitenvalven, scharf (30-4300-16)
- 1 Mittelvalve 19 x 16 mm (30-4300-19)
- 1 Mittelvalve 25 x 16 mm (30-4300-25)
- 1 Mittelvalve 32 x 16 mm (30-4300-32)

complete, consisting of:

- 1 Spreader with lateral valves, sharp (30-4300-16)
- 1 Central valve 19 x 16 mm (30-4300-19)
- 1 Central valve 25 x 16 mm (30-4300-25)
- 1 Central valve 32 x 16 mm (30-4300-32)

completo, compuesto of:

- 1 Separador con valvas laterales, agudas (30-4300-16)
- 1 Valva central 19 x 16 mm (30-4300-19)
- 1 Valva central 25 x 16 mm (30-4300-25)
- 1 Valva central 32 x 16 mm (30-4300-32)

completo, composto da:

- 1 Divaricatore con valve laterali, acuto (30-4300-16)
- 1 Valva centrale 19 x 16 mm (30-4300-19)
- 1 Valva centrale 25 x 16 mm (30-4300-25)
- 1 Valva centrale 32 x 16 mm (30-4300-32)

**HENLEY
30-4301-00**

komplett, bestehend aus:

- 1 Sperrer mit Seitenvalven, stumpf (30-4301-16)
- 1 Mittelvalve 19 x 16 mm (30-4300-19)
- 1 Mittelvalve 25 x 16 mm (30-4300-25)
- 1 Mittelvalve 32 x 16 mm (30-4300-32)

complete, consisting of:

- 1 Spreader with lateral valves, blunt (30-4301-16)
- 1 Central valve 19 x 16 mm (30-4300-19)
- 1 Central valve 25 x 16 mm (30-4300-25)
- 1 Central valve 32 x 16 mm (30-4300-32)

completo, compuesto of:

- 1 Separador con valvas laterales, romas (30-4301-16)
- 1 Valva central 19 x 16 mm (30-4300-19)
- 1 Valva central 25 x 16 mm (30-4300-25)
- 1 Valva central 32 x 16 mm (30-4300-32)

completo, composto da:

- 1 Divaricatore con valve laterali, smusso (30-4301-16)
- 1 Valva centrale 19 x 16 mm (30-4300-19)
- 1 Valva centrale 25 x 16 mm (30-4300-25)
- 1 Valva centrale 32 x 16 mm (30-4300-32)

Wundspreizer, Bauchdeckenhalter
Self-Retaining Retractors, Abdominal Retractors
Separadores con retenida automática, Separadores abdominales
Divaricatori autostatici, Divaricatori addominali



MAYO-ADAMS
 17,0 cm, 6³/₄"
 30-4320-17



COLLIN-BABY
 18,0 cm, 7"
 30-4330-18

30 x 44 mm
 30-4330-30



23 x 44 mm
 30-4330-23

Wechselvalven
 Exchangeable blades
 Valvas intergambiabiles
 Valve intercambiabili



RICARD
 28,0 cm, 11"
 31-4310-28



RICARD
 30,0 cm, 12"
 31-4312-30

Wundspreizer, Bauchdeckenhalter
Self-Retaining Retractors, Abdominal Retractors
Separadores con retenida automática, Separadores abdominales
Divaricatori autostatici, Divaricatori addominali



COLLIN
 23,5 cm, 9¹/₄"
 31-4330-24

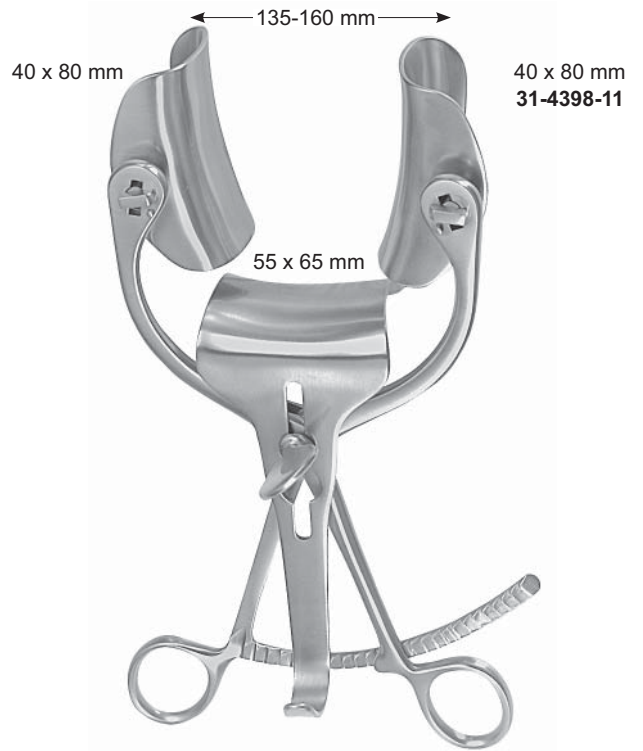

COLLIN
 23,5 cm, 9¹/₄"
 31-4332-24



COLLIN
 23,5 cm, 9¹/₄"
 31-4334-24

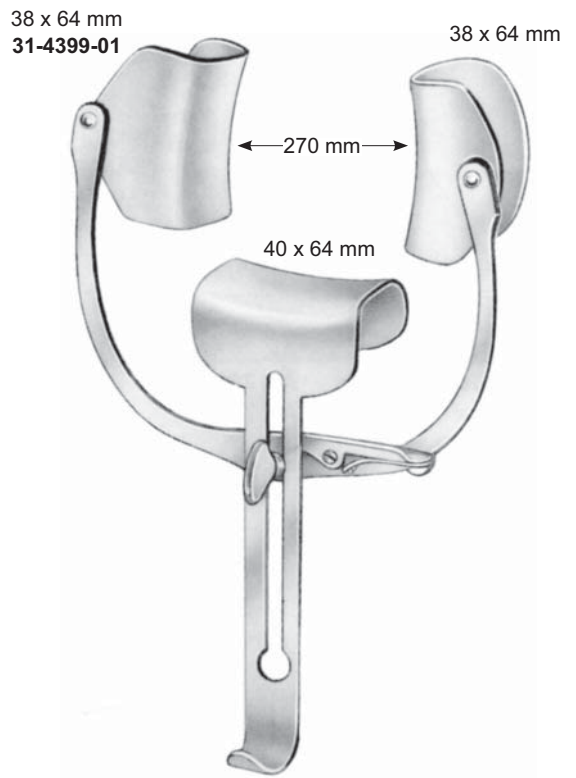

ROBIN-MASSE
 31-4360-27

Wundspreizer, Bauchdeckenhalter
Self-Retaining Retractors, Abdominal Retractors
Separadores con retenida automática, Separadores abdominales
Divaricatori autostatici, Divaricatori addominali



38 x 62 mm **31-4399-01**
 40 x 80 mm **31-4399-02**
 60 x 80 mm **31-4399-03**

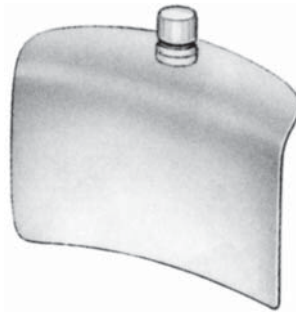

50 x 58 mm **31-4399-10**
 60 x 80 mm **31-4399-13**
 72 x 85 mm **31-4399-14**



31-4399-23
 60 x 80 mm

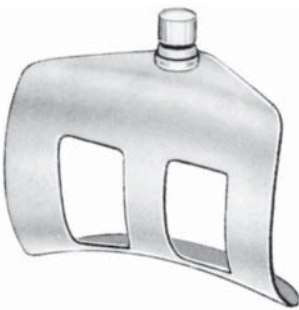

31-4399-33
 60 x 80 mm



58 x 50 mm **31-4398-01**
 80 x 60 mm **31-4398-02**
 85 x 72 mm **31-4398-03**



62 x 38 mm **31-4398-10**
 80 x 38 mm **31-4398-11**
 100 x 38 mm **31-4398-12**
 80 x 38 mm **31-4398-13**



COLLIN
 55 x 55 mm **31-4331-01**
 55 x 65 mm **31-4331-02**
 55 x 75 mm **31-4331-03**

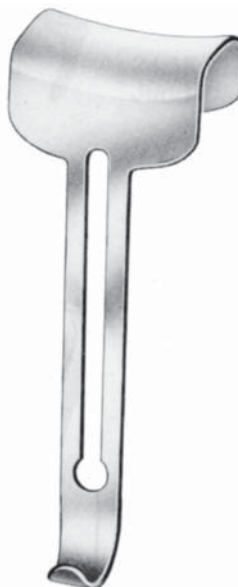

ROBIN-MASSE
 40 x 64 mm **31-4360-01**
 55 x 65 mm **31-4360-02**
 55 x 75 mm **31-4360-03**



RICARD
 65 x 50 mm **31-4310-01**
 70 x 55 mm **31-4310-02**
 90 x 80 mm **31-4310-03**

Bauchdeckenhalter
Abdominal Retractors
Separadores abdominales
Divaricatori addominali

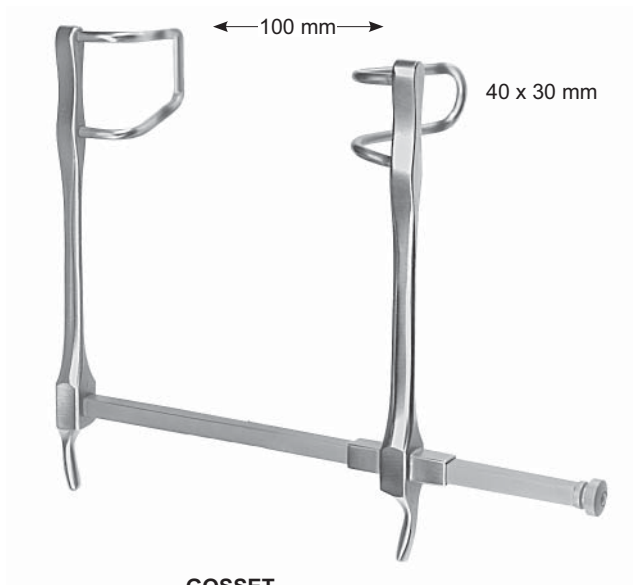

GOSSET
31-4400-10



GOSSET
31-4412-14



GOSSET
31-4414-16

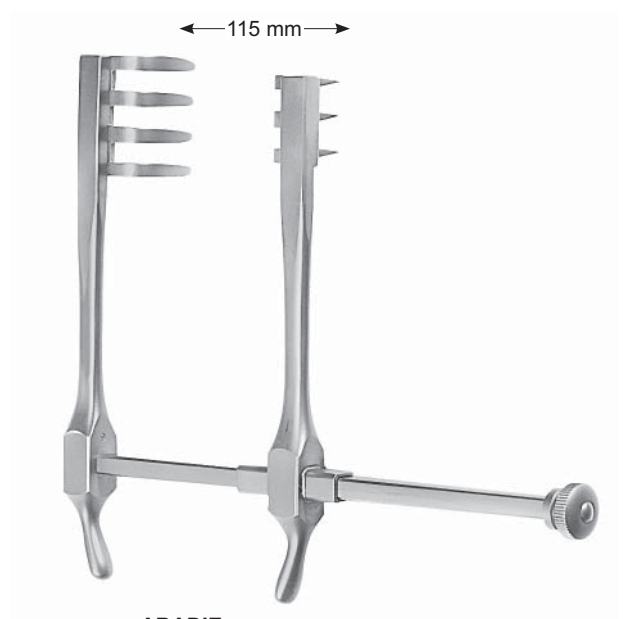

ABADIE
31-4450-12

Bauchdeckenhalter
Abdominal Retractors
Separadores abdominales
Divaricatori addominali

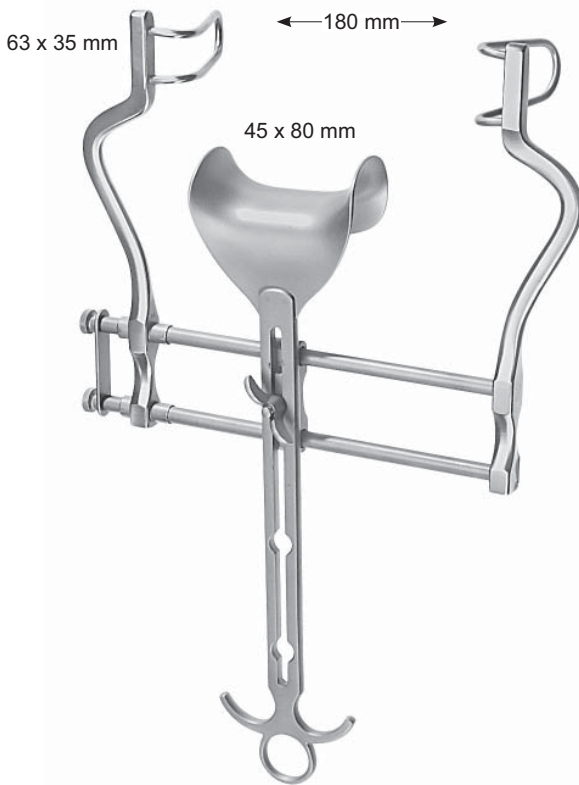

BALFOUR
31-4764-18

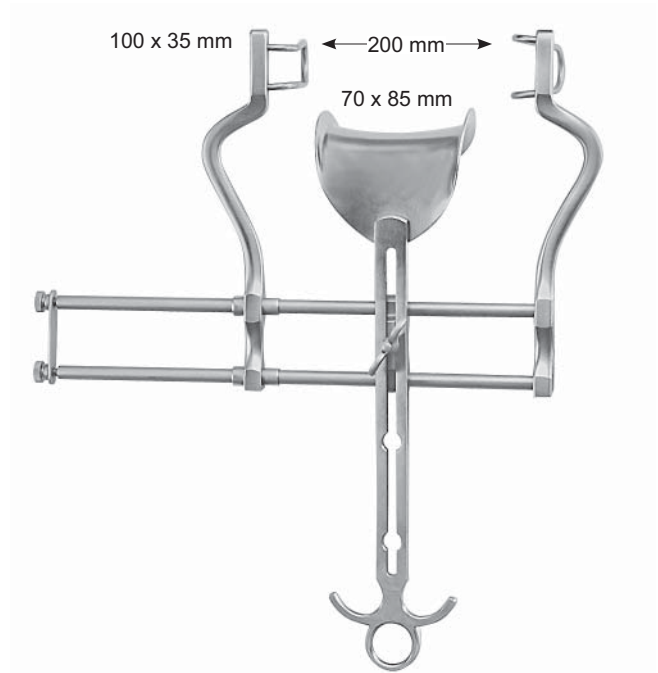

BALFOUR
31-4768-20

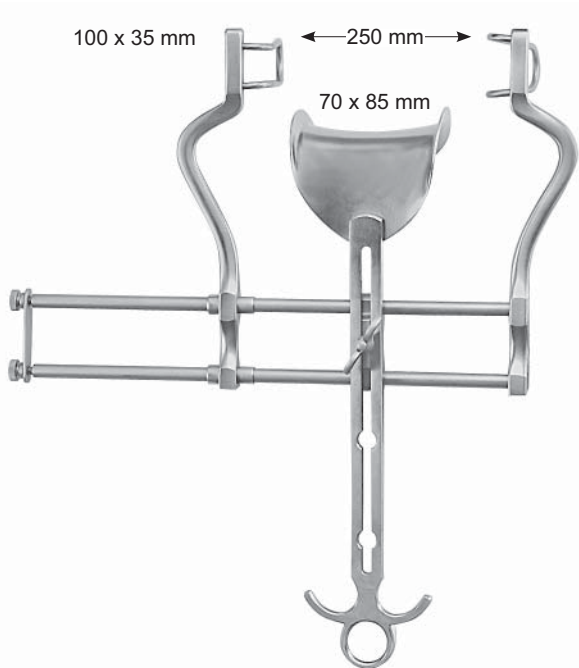

BALFOUR
31-4768-25

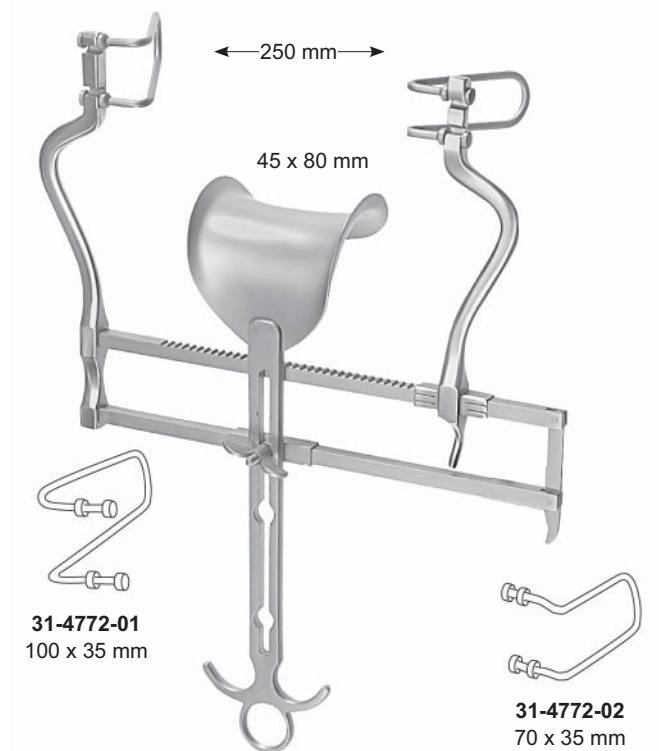

BALFOUR US-TYPE
31-4772-25

31-4772-01
100 x 35 mm

31-4772-02
70 x 35 mm

Bauchdeckenhalter
Abdominal Retractors
Separadores abdominales
Divaricatori addominali



BALFOUR
100 x 70 mm
31-4799-70

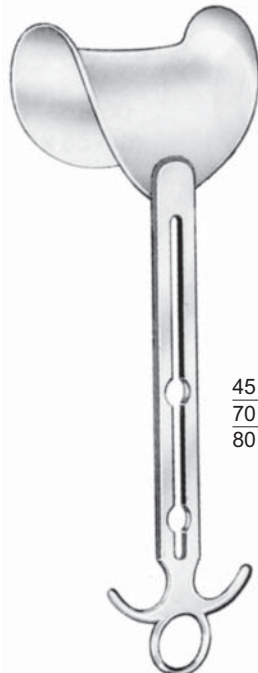

BALFOUR

45 x 80 mm **31-4798-01**
70 x 85 mm **31-4798-02**
80 x 90 mm **31-4798-03**

27 x 27 mm

← 90 mm →

24 x 20 mm
31-4760-24

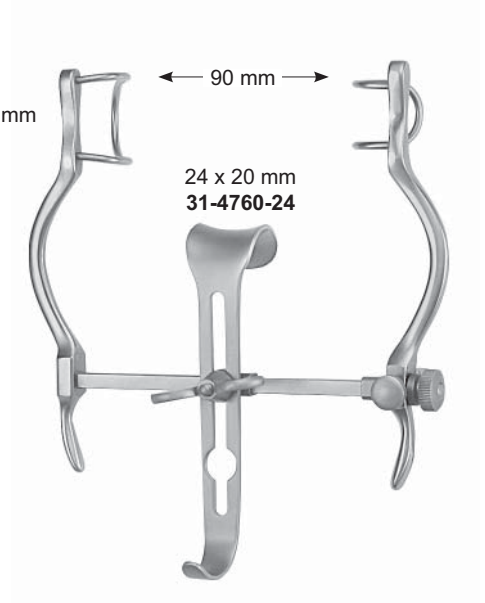

BALFOUR
31-4760-09

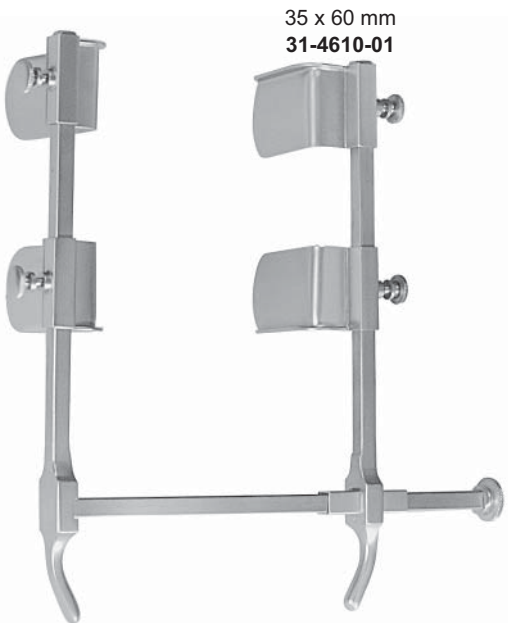

35 x 60 mm
31-4610-01

BERKELEY
31-4610-00

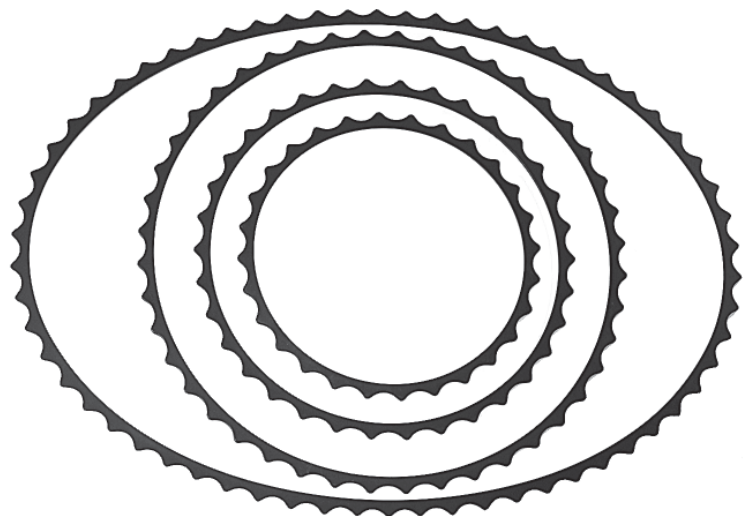

Ø 180 mm, 7" **31-4850-18**
Ø 230 mm, 9" **31-4850-23**
Ø 305 mm, 12" **31-4850-30**
455 x 330 mm **31-4850-45**

Bauchdeckenhalter
Abdominal Retractors
Separadores abdominales
Divaricatori addominali

geschwärzt, black finish, negra, nera



31-4859-01
13 mm



31-4859-02
51 x 38 mm



31-4859-03
70 x 60 mm



31-4859-04
89 x 60 mm



31-4859-05
114 x 60 mm

geschwärzt, black finish, negra, nera



31-4859-06
19 x 76 mm



31-4859-07
38 x 102 mm



31-4859-08
57 x 89 mm



31-4859-09
57 x 114 mm

**Bauchdeckenhalter
Abdominal Retractors
Separadores abdominales
Divaricatori addominali**

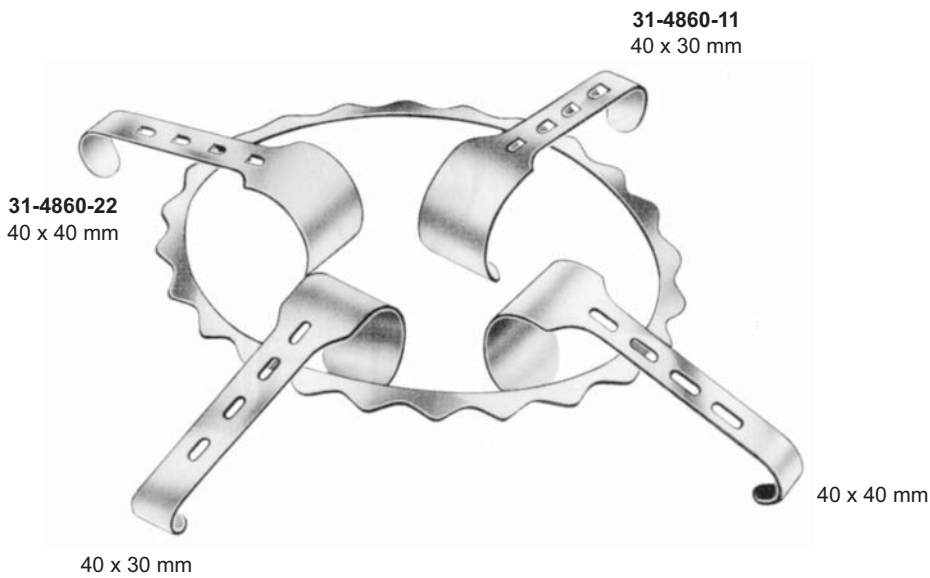

31-4860-01
255 x 180 mm
Rahmen allein
frame only
cuadro suelto
solo telaio

DENNIS BROWN
255 x 180 mm
31-4860-00
komplett
complete
completo
completo

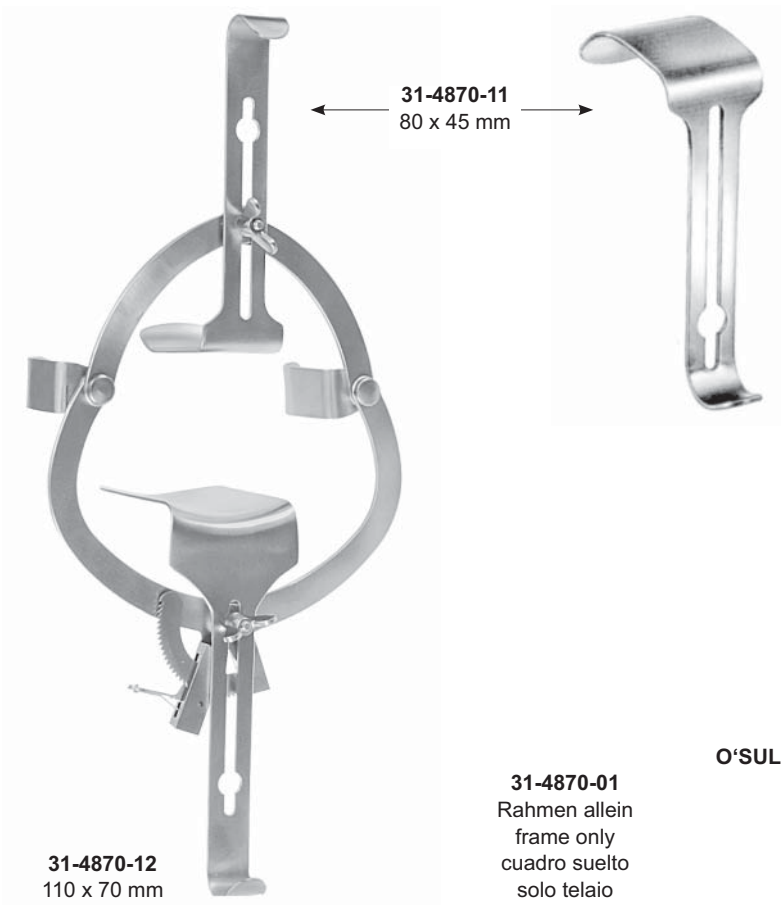

Bauchdeckenhalter
Abdominal Retractors
Separadores abdominales
Divaricatori addominali

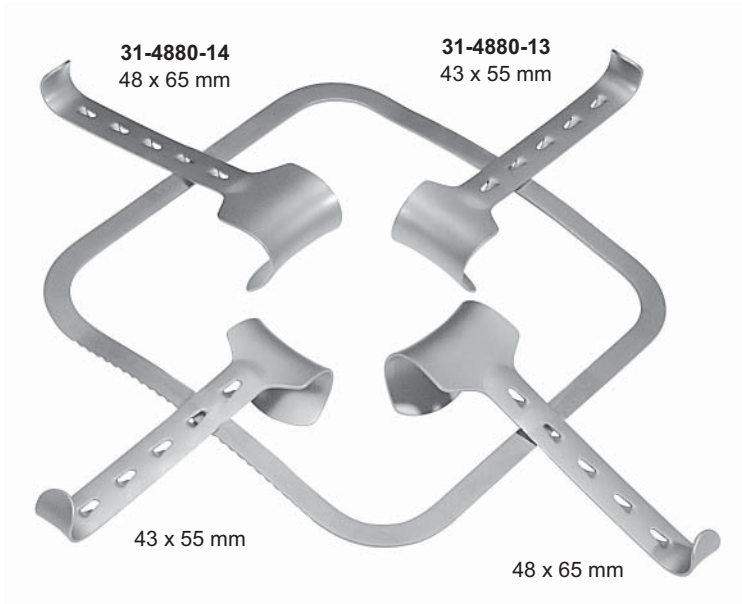

31-4880-01 250 x 250 mm
31-4880-02 300 x 320 mm
31-4880-03 300 x 380 mm
 Rahmen allein
 frame only
 cuadro suelto
 solo telaio

KIRSCHNER
31-1880-00
 komplett
 complete
 completo
 completo
 1 x 31-4880-01
 2 x 31-4880-13
 2 x 31-4880-14

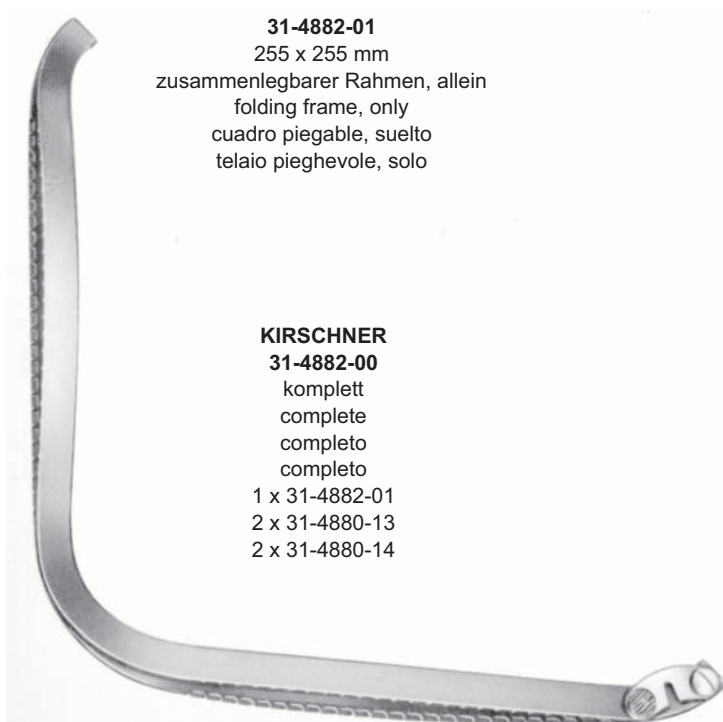

31-4882-01
 255 x 255 mm
 zusammenlegbarer Rahmen, allein
 folding frame, only
 cuadro plegable, suelto
 telaio pieghevole, solo

KIRSCHNER
31-4882-00
 komplett
 complete
 completo
 completo
 1 x 31-4882-01
 2 x 31-4880-13
 2 x 31-4880-14



43 x 55 mm	31-4880-13
48 x 65 mm	31-4880-14
80 x 90 mm	31-4880-15
90 x 65 mm	31-4880-16
98 x 95 mm	31-4880-17

KIRSCHNER

Bauchdeckenhalter
Abdominal Retractors
Separadores abdominales
Divaricatori addominali



KIRSCHNER
60 x 82 mm
31-4880-11



KIRSCHNER-BALFOUR
83 x 82 mm
31-4880-12



KIRSCHNER
98 x 51 mm 31-4880-20
105 x 38 mm 31-4880-21

31-4880-14
48 x 65 mm

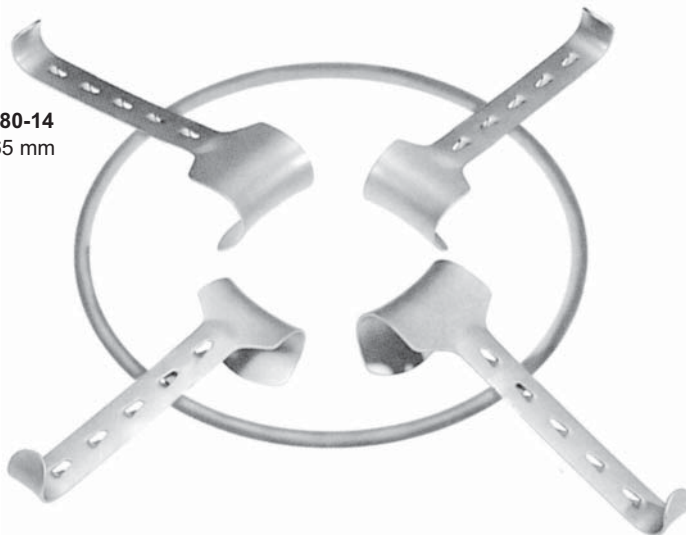

31-4890-00
300 x 240 mm
Rahmen allein
frame only
cuadro suelto
solo telaio

31-4880-15
80 x 90 mm

KIRSCHNER, oval
31-4884-00
komplett, complete, completo, completo
1 x 31-4884-01
3 x 31-4880-14
1 x 31-4880-15
1 x 31-4880-20
1 x 31-4880-21

Bauchdeckenhalter
Abdominal Retractors
Separadores abdominales
Divaricatori addominali

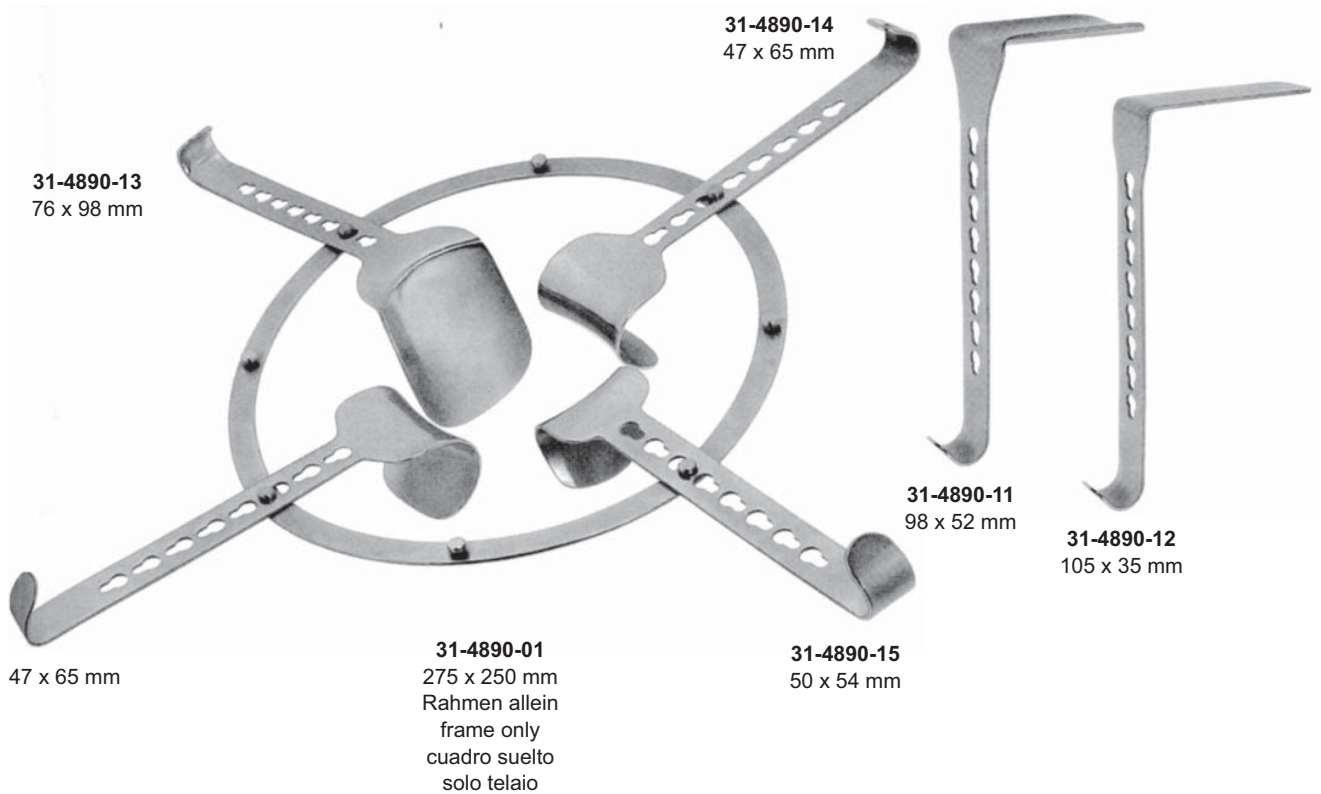

31-4890-13
76 x 98 mm

31-4890-14
47 x 65 mm

31-4890-11
98 x 52 mm

31-4890-12
105 x 35 mm

47 x 65 mm

31-4890-01
275 x 250 mm
Rahmen allein
frame only
cuadro suelto
solo telaio

31-4890-15
50 x 54 mm

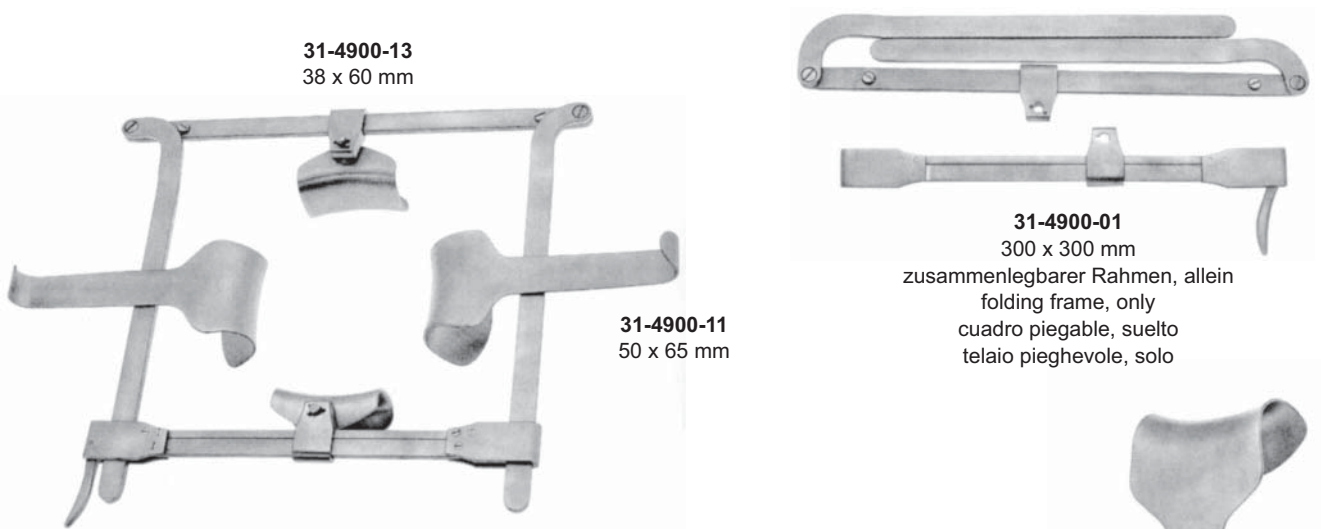

31-4900-13
38 x 60 mm

31-4900-11
50 x 65 mm

31-4900-01
300 x 300 mm
zusammenlegbarer Rahmen, allein
folding frame, only
cuadro plegable, suelto
telaio pieghevole, solo

FRANZ
31-4900-00
 komplett
 complete
 completo
 completo
 1 x 31-4900-01
 2 x 31-4900-11
 2 x 31-4900-13

31-4900-13
38 x 60 mm
31-4900-14
45 x 80 mm

31-4900-11
50 x 65 mm
31-4900-12
60 x 85 mm

Bauchdeckenhalter
Abdominal Retractors
Separadores abdominales
Divaricatori addominali

für / for / para / per
 31-4910-11
 31-4910-14



95 x 60 mm	31-4910-11
105 x 65 mm	31-4910-12
115 x 65 mm	31-4910-13
125 x 65 mm	31-4910-14

DOYEN
 28,0 cm, 11"



Kette mit Gewicht
 Chain with weight
 Cadena con pesa
 Catena con peso

31-4915-30
 78,5 cm, 31"



53,0 cm, 21"
 66,0 cm, 26"

Befestigungsgestell
 Mounting frame
 Bastidor para la fijación
 Telaio di supporto per il fissaggio

ROCHARD
31-4920-01



53,0 cm, 21"
 66,0 cm, 26"

Befestigungsgestell
 Mounting frame
 Bastidor para la fijación
 Telaio di supporto per il fissaggio

ROCHARD
31-4920-02

95 x 48 mm	31-4920-10
105 x 48 mm	31-4920-12
115 x 48 mm	31-4920-12
125 x 48 mm	31-4920-13
155 x 48 mm	31-4920-16



ROCHARD
 28,0 cm, 11"
31-4920-20

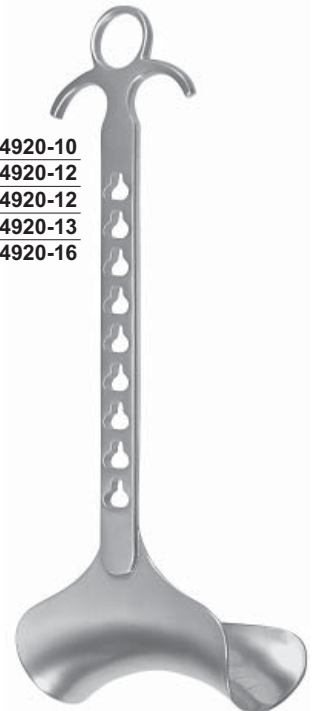

ROCHARD
 28,0 cm, 11"

Bauchspatel
Abdominal Spatulas
Espátulas abdominales
Spatole addominali



biegsam
 malleable
 maleable
 malleabile

200 x 6 mm **32-4210-06**
200 x 12 mm **32-4210-12**
200 x 17 mm **32-4210-17**
200 x 20 mm **32-4210-20**
200 x 25 mm **32-4210-25**



biegsam
 malleable
 maleable
 malleabile

330 x 13 mm **32-4170-13**
330 x 25 mm **32-4170-25**
330 x 32 mm **32-4170-32**
330 x 40 mm **32-4170-40**
330 x 50 mm **32-4170-50**

RIBBON



biegsam
 malleable
 maleable
 malleabile

280 x 25/30 mm **32-4200-01**
300 x 37/45 mm **32-4200-02**
300 x 40/50 mm **32-4200-03**

RIBBON

RIBBON



biegsam
 malleable
 maleable
 malleabile

TUFFIER
 200 x 25/17 mm
32-4220-20



REVERDIN
 280 x 45/60 mm
32-4230-28

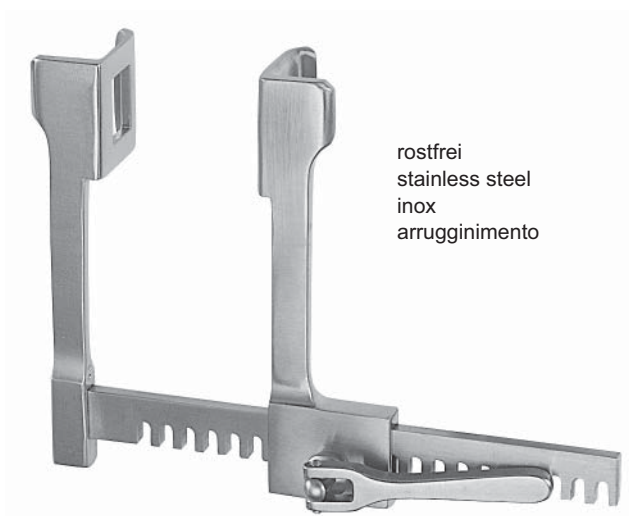

rostfrei
stainless steel
inox
arrugginimento

a	b	c	
18 mm	20 mm	75 mm	47-4100-01

FINOCCHIETTO-BABY

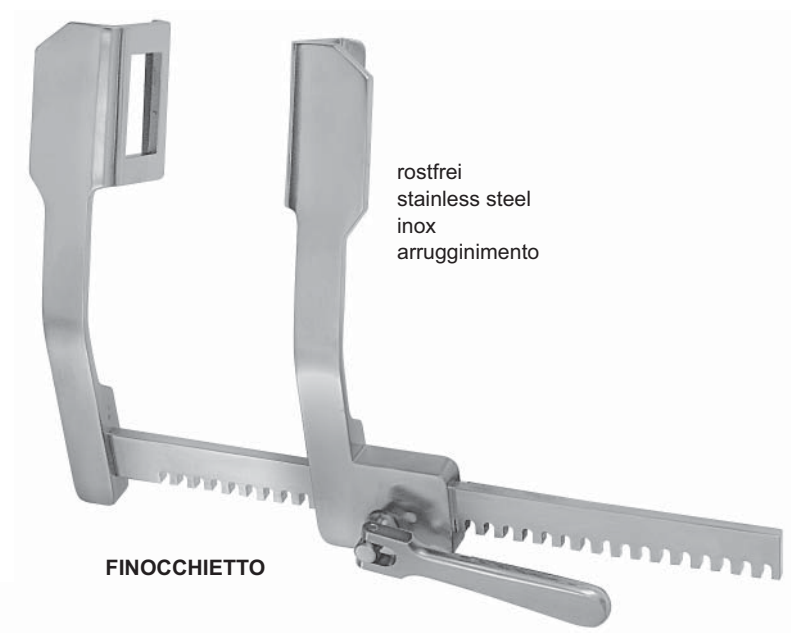

rostfrei
stainless steel
inox
arrugginimento

a	b	c	
40 mm	40 mm	165 mm	47-4100-02
45 mm	65 mm	200 mm	47-4100-03
70 mm	65 mm	250 mm	47-4100-04

FINOCCHIETTO



rostfrei
stainless steel
inox
arrugginimento

a	b	c	
50 mm	45 mm	165 mm	47-4150-01

TUFFIER

Sonden, Trokare
Probes, Trocars
Sondas, Trócares
Sonde, Trequarti



Sonden
Probes
Sondas
Sonde

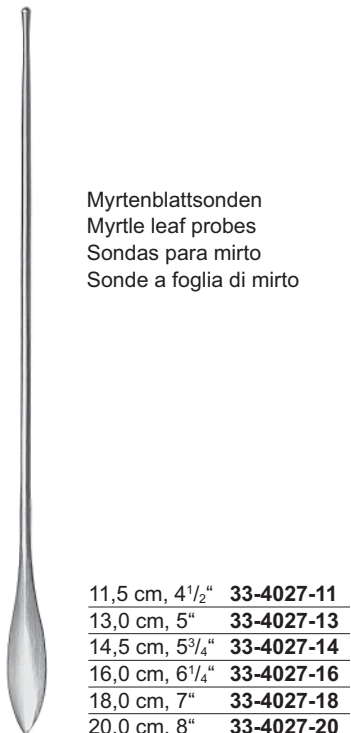
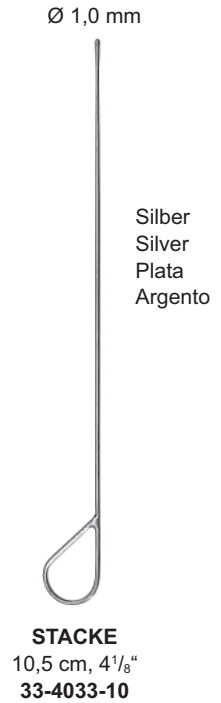
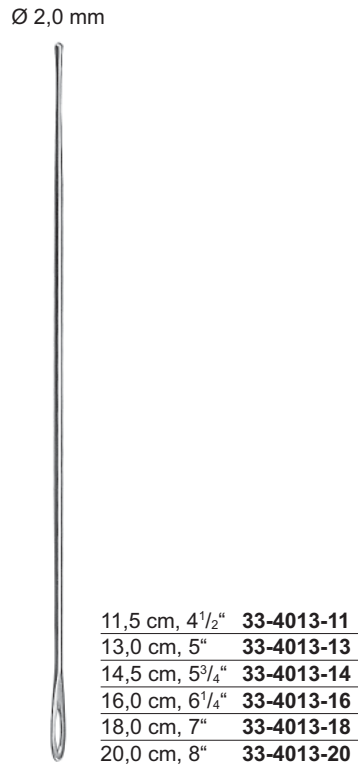
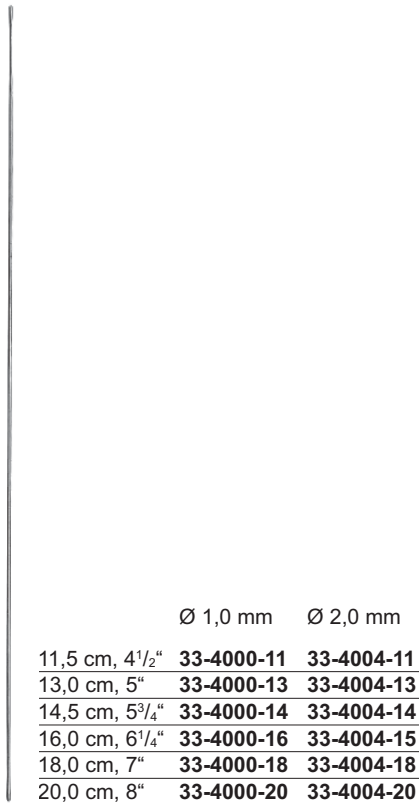

Ø 3,5 mm

Ø 3,5 mm



11,5 cm, 4 ¹ / ₂ "	33-4110-11
13,0 cm, 5"	33-4110-13
14,5 cm, 5 ³ / ₄ "	33-4110-14
16,0 cm, 6 ¹ / ₄ "	33-4110-16
18,0 cm, 7"	33-4110-18
20,0 cm, 8"	33-4110-20

Ø 3,3 mm



13,0 cm, 5"	33-4122-13
14,5 cm, 5 ³ / ₄ "	33-4122-14
16,0 cm, 6 ¹ / ₄ "	33-4122-16
18,0 cm, 7"	33-4122-18



LOCKHART-MUMMERY
16,5 cm, 6¹/₂"
33-4130-01



LOCKHART-MUMMERY
16,5 cm, 6¹/₂"
33-4130-02

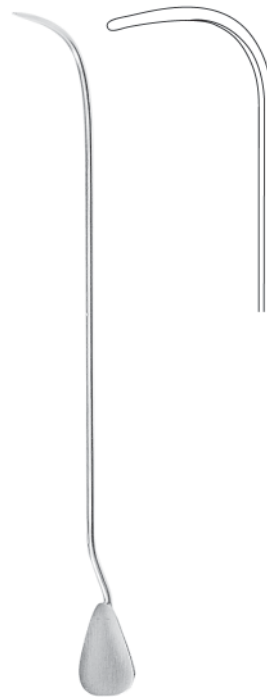

LOCKHART-MUMMERY
16,5 cm, 6¹/₂"
33-4130-03



LOCKHART-MUMMERY
16,5 cm, 6¹/₂"
33-4130-04

Watteträger
 Cotton Applicators
 Porta-algodones
 Porta-cotone

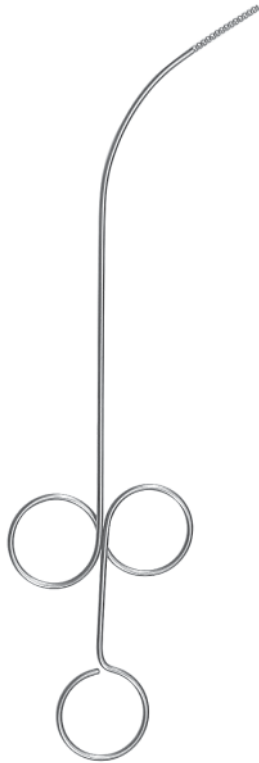

FEIN
 28,0 cm, 11"
 33-4264-28



UKERMANN
 16,0 cm, 6 1/4"
 33-4260-16



JOBSON-HORNE
 18,0 cm, 7"
 33-4262-18



12,0 cm, 4 3/4"	33-4271-12	Ø 0,9 mm
14,0 cm, 5 3/4"	33-4271-14	Ø 0,9 mm
16,5 cm, 6 1/4"	33-4271-16	Ø 1,1 mm
18,0 cm, 7"	33-4271-18	Ø 1,2 mm

**FARRELL
 (LATHBURY)**



12,0 cm, 4 3/4"	33-4270-12	Ø 0,9 mm
14,0 cm, 5 3/4"	33-4270-14	Ø 0,9 mm
16,5 cm, 6 1/4"	33-4270-16	Ø 1,1 mm
18,0 cm, 7"	33-4270-18	Ø 1,2 mm

FARRELL

Krampfader-Besteck
Varicose Vein Probe Set
Juego para várices
Astuccio per varici



33-4150-01
 Metalletui
 Metal case
 Estuche de metal
 Scatola in metallo

135 x 100 x 25 mm

NABATOFF
33-4150-00
 komplett
 complete
 completo
 completo



Ø 3,0 mm
33-4150-03



Ø 6,0 mm
33-4150-06



Ø 9,0 mm
33-4150-09



33-4150-21
 Zugseil
 Cable
 Cable
 Fune

33-4150-22
 Kunststoff-Sondenspitze
 Plastic probe tip
 Extremidad de sonda de plástico
 Punta in materia plastica



Ø 12,0 mm
33-4150-12

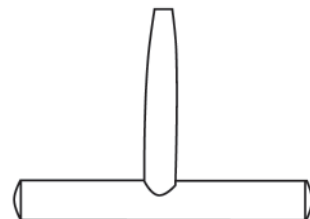

33-4150-20
 Handgriff
 Handle
 Mango
 Manico

Trokare
Trocars
Trócares
Trequarti



Ø 3,0 mm	34-4110-30
Ø 3,5 mm	34-4110-35
Ø 4,0 mm	34-4110-40
Ø 4,5 mm	34-4110-45
Ø 5,0 mm	34-4110-50
Ø 5,5 mm	34-4110-55
Ø 6,0 mm	34-4110-60

STANDARD
11,0 cm, 4³/₈"



Ø 3,0 mm	34-4112-30
Ø 3,5 mm	34-4112-35
Ø 4,0 mm	34-4112-40
Ø 4,5 mm	34-4112-45
Ø 5,0 mm	34-4112-50
Ø 5,5 mm	34-4112-55
Ø 6,0 mm	34-4112-60

STANDARD
12,0 cm, 4³/₄"



Ø 3,0 mm	34-4114-30
Ø 3,5 mm	34-4114-35
Ø 4,0 mm	34-4114-40
Ø 4,5 mm	34-4114-45
Ø 5,0 mm	34-4114-50
Ø 5,5 mm	34-4114-55
Ø 6,0 mm	34-4114-60

STANDARD
12,0 cm, 4³/₄"



Ø 7,3 mm	34-4118-07
Ø 8,7 mm	34-4118-09
Ø 12,0 mm	34-4118-12

HURWITZ

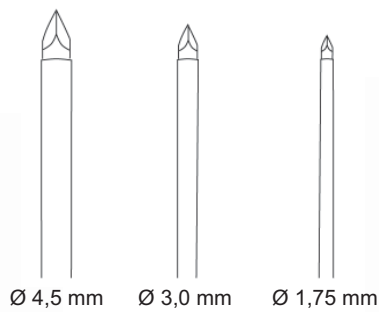

UNIVERSAL
34-4100-03

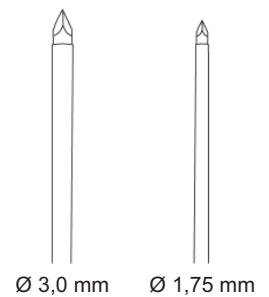
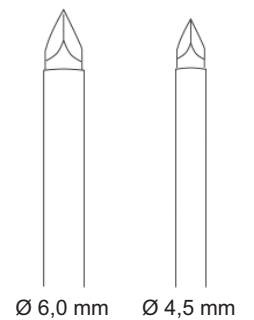

UNIVERSAL
34-4100-04

Trokare
Trocars
Trócares
Trequarti

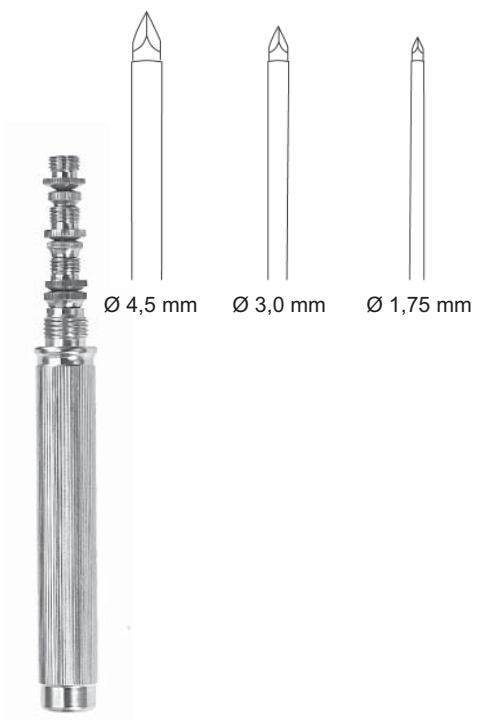

UNIVERSAL
34-4102-03

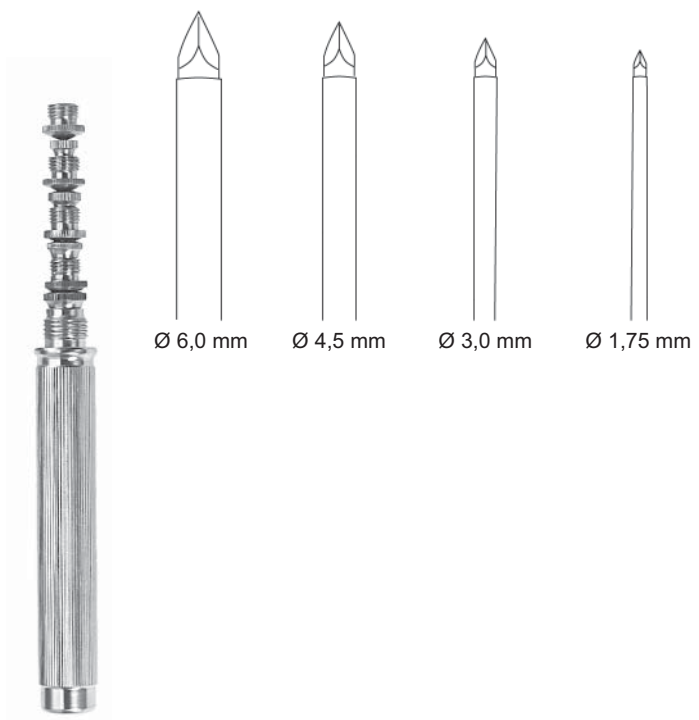

UNIVERSAL
34-4102-04

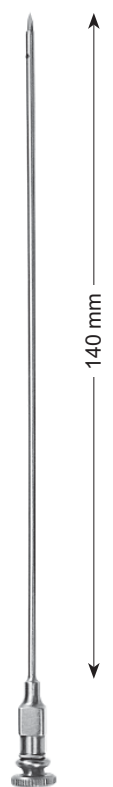

LANDAU
Ø 2,0 mm
33-4160-16

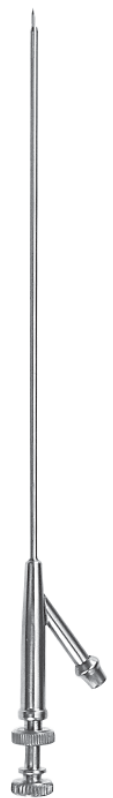

LANDAU
Ø 2,0 mm
33-4161-16



DAVIDSON
Ø 6,0 mm
33-4164-18



BUELAU
Ø 8,0 mm
33-4124-24

Trokare
Trocars
Trócares
Trenuarti



Ø 2,0 mm	34-4130-20
Ø 2,5 mm	34-4130-25
Ø 3,0 mm	34-4130-30

LERMOYEZ

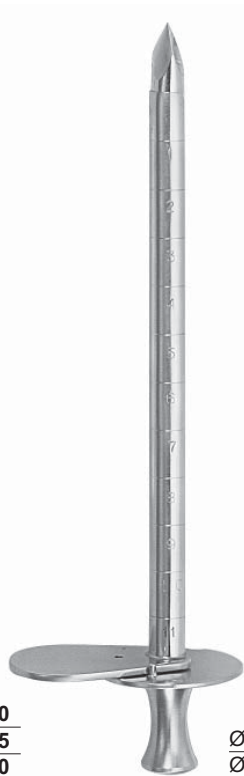

Ø 6,0 mm	34-4128-06
Ø 8,0 mm	34-4128-08

CAMPBELL
16,0 cm, 6¼"



80 mm

Ø 7,5 mm	34-4120-01
Ø 9,0 mm	34-4120-02
Ø 10,5 mm	34-4120-03
Ø 12,0 mm	34-4120-04

NELSON
21,0 cm, 8½"



100 mm

Ø 4,0 mm	34-4140-01
Ø 4,6 mm	34-4140-02
Ø 5,5 mm	34-4140-03
Ø 6,5 mm	34-4140-04

OCHSNER
14,0 cm, 5½"



Record Konus
Record cone



Ø 3,0 mm	34-4180-30
Ø 4,0 mm	34-4180-40
Ø 5,0 mm	34-4180-50

PIERCE
16,0 cm, 6¼"

Ø 2,25 mm



COAKLEY
14,0 cm, 5¼"
34-4190-14



Ø 4,0 mm

KRAUSE
16,0 cm, 6¼"

LICHTWITZ
Kieferhöhlentrocars
Antrum trocars
Trócares para el seno maxilar
Trequarti per puntura del seno mascellare

Ø 1,8 mm

Ø 3,0 mm **34-4184-30**
Ø 4,0 mm **34-4184-40**
Ø 5,0 mm **34-4184-50**
Ø 5,5 mm **34-4184-55**

LICHTWITZ
20,0 cm, 8"
34-4170-00

Trokare, Saugrohre
Trocars, Suction Tubes
Trócares, Tubos para aspiración
Trequarti, Tubi aspirazione

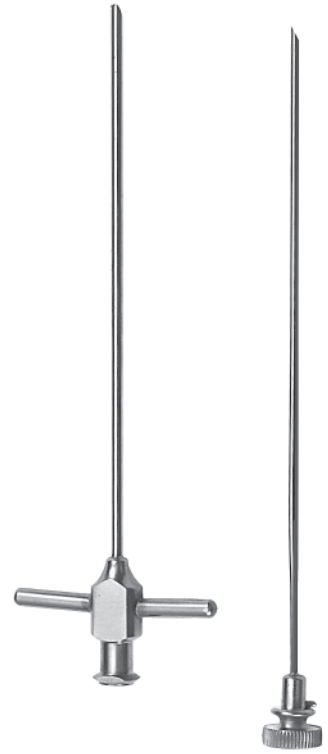

LICHTWITZ
11,0 cm, 4½"
34-4172-00



DOUGLAS
Ø 3,0 mm
34-4175-00



Ø 6,0 mm **35-4020-06**
Ø 10,0 mm **35-4020-10**

POOLE
22,0 cm, 8⅝"



Ø 6,0 mm **35-4021-06**
Ø 8,0 mm **35-4021-08**

POOLE
22,0 cm, 8⅝"

Saugrohre
Suction Tubes
Tubos para aspiración
Tubi aspirazione

auswechselbare Spitze
interchangeable tip
punta intercambiabile
tipo intercambiabile



Ø 3,5 mm
35-4010-35



35-4024-00
Olive allein
Olive only
Oliva suelto
Olivo solo



COUPLAND
17,0 cm, 6³/₄"
35-4010-17



YANKAUER
27,0 cm, 10⁵/₈"
35-4000-27



DE BAKEY
27,0 cm, 10⁵/₈"
35-4008-27



ANTHONY
26,0 cm, 10¹/₄"
35-4007-26



ANDREWS-PYNCHON
24,0 cm, 9¹/₂"
35-4006-24



COOLEY
35,0 cm, 13³/₄"
Ø 8,0 mm
35-4024-02



COOLEY
30,0 cm, 11³/₄"
Ø 7,0 mm
35-4024-03



COOLEY
31,0 cm, 11³/₄"
Ø 10,0 mm
35-4024-04



COOLEY
33,0 cm, 13"
Ø 8,0 mm
35-4024-01

Ø 2,0 mm



COGSWELL
23,0 cm, 9"
35-4014-23

Saugrohre
Suction Tubes
Tubos para aspiración
Tubi aspirazione



BYRD
20,0 cm, 8"

Ø 1,5 mm	35-4012-15
Ø 2,5 mm	35-4012-25
Ø 3,5 mm	35-4012-35



HEPP/SCHIEDL
22,5 cm, 8³/₄"
35-4016-22

Ø 4,0 mm



ADSON
21,0 cm, 8¹/₄"
35-4050-21



MAGILL
17,5 cm, 6⁵/₈"

Ø 1,0 mm	35-4060-01
Ø 2,0 mm	35-4060-02
Ø 3,0 mm	35-4060-03
Ø 4,0 mm	35-4060-04



FRAZIER
19,0 cm, 7¹/₂"

Charr. 6	35-4030-06
Charr. 8	35-4030-08
Charr. 10	35-4030-10
Charr. 12	35-4030-12



FERGUSON
18,0 cm, 7"

Charr. 6	35-4033-06
Charr. 8	35-4033-08
Charr. 10	35-4033-10
Charr. 12	35-4033-12

POPPE
13,0 cm, 5"

Charr. 6	35-4034-06
Charr. 8	35-4034-08
Charr. 10	35-4034-10
Charr. 12	35-4034-12

Spezialkanülen
Special Needles
Agujas especiales
Aghi speciali



Packung zu 12 Stück
 Package of 12 pcs.
 Cajecita de 12 pzs.
 Confezione da 12 pezzi

Ø 0,90 x 38 mm	36-4000-01
Ø 0,80 x 32 mm	36-4000-02
Ø 0,70 x 32 mm	36-4000-03
Ø 0,65 x 28 mm	36-4000-04
Ø 0,60 x 25 mm	36-4000-05
Ø 0,50 x 23 mm	36-4000-06
Ø 0,45 x 20 mm	36-4000-07

LUER-LOCK



IOWA
 14,0 cm, 5 1/4"
36-4150-14

Ø 1,0 x 185 mm

36-4150-01
 Nadel
 Needle
 Aguja
 Aghi



MOCK
 6,0 cm, 2 3/8"
36-4200-06



SCHMID
 15,0 cm, 6"



Gefäßspülkanülen, biegsam
 Vascular irrigation cannulae, malleable
 Cánulas vasculares para irrigación, maleables
 Aghi vascolari per irrigazione, malleabili

Saugrohre
Suction Tubes
Tubos para aspiración
Tubi aspirazione



Ø 1,20 x 80 mm **36-4210-12**
 Ø 1,50 x 80 mm **36-4210-15**



VERESS

Ø 2,00 x 100 mm **36-4180-10**
 Ø 2,00 x 120 mm **36-4180-12**
 Ø 2,00 x 150 mm **36-4180-15**

Kanülen zur Sternalpunktion
 Sternum puncture needles
 Agujas para la punción del esternón
 Aghi per puntura dello sterno



KLIMA-ROSSEGGER
 Ø 1,60 x 40 mm
36-4060-16



SELDINGER-STILLE

Ø 1,60 x 70 mm **36-4650-16**
 Ø 2,00 x 70 mm **36-4650-20**

Kanülen zur Lumbalpunktion
 Lumbar puncture needles
 Agujas para punción lumbar
 Aghi per punture lombari



BIER

Ø 0,8 x 70/80/90/100/120 mm **36-4130-01**
 Ø 1,0 x 70/80/90/100/120 mm **36-4130-02**
 Ø 1,2 x 70/80/90/100/120 mm **36-4130-03**
 Ø 1,4 x 70/80/90/100/120 mm **36-4130-04**
 Ø 1,6 x 70/80/90/100/120 mm **36-4130-05**
 Ø 1,8 x 70/80/90/100/120 mm **36-4130-06**
 Ø 2,0 x 70/80/90/100/120 mm **36-4130-07**

Spezialkanülen
Special Needles
Agujas especiales
Aghi speciali



Kanülen zur Lumbalpunktion
 Lumbar puncture needles
 Aguja para punción lumbar
 Aghi per punture lombari

Ø 1,20 x 76 mm	36-4120-01
Ø 1,20 x 89 mm	36-4120-02
Ø 1,00 x 76 mm	36-4120-03
Ø 1,00 x 89 mm	36-4120-04
Ø 0,70 x 76 mm	36-4120-05
Ø 0,70 x 50 mm	36-4120-06
Ø 0,70 x 89 mm	36-4120-07

QUINKE

Kanülen zur Lumbalpunktion
 Lumbar puncture needles
 Aguja para punción lumbar
 Aghi per punture lombari

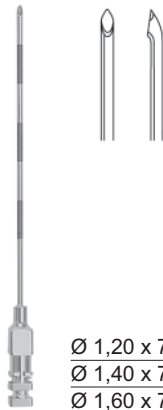

Ø 1,20 x 76 mm	36-4090-12
Ø 1,40 x 76 mm	36-4090-14
Ø 1,60 x 76 mm	36-4090-16

TUHOJ

Kanülen zur Leberblindpunktion
 Liver blind puncture needles
 Aguja para punción ciega del hígado
 Aghi per punture cieca del fegato



Ø 1,00 x 35 mm	36-4115-01
Ø 1,00 x 70 mm	36-4115-02
Ø 1,20 x 70 mm	36-4115-03
Ø 1,20 x 100 mm	36-4115-04
Ø 1,40 x 70 mm	36-4115-05
Ø 1,40 x 100 mm	36-4115-06
Ø 1,60 x 70 mm	36-4115-07
Ø 1,60 x 100 mm	36-4115-08

MENGHINI



Kanülen zur gezielten Leberpunktion
 Needles for controlled liver puncture
 Aguja para la punción del hígado bajo el control laparoscópico
 Aghi per la punture controllata del fegato

Ø 1,40 x 168 mm	36-4117-14
Ø 1,80 x 168 mm	36-4117-18

MENGHINI



Trokare für Kanülen
 Trocars for needles
 Trocares para agujas
 Trequarti oer aghi

Ø 1,40 x 168 mm	36-4230-14
Ø 1,80 x 168 mm	36-4230-18

Spritzen, Ersatzzylinder
 Syringes, Spare barrel
 Jeringas, Cilindro de reposito
 Siringhe, Cilindro di ricambio



1 ml **37-4051-01**
 2 ml **37-4051-02**
 5 ml **37-4051-05**
 10 ml **37-4051-10**
 20 ml **37-4051-20**
 50 ml **37-4051-50**



1 ml **37-4001-01**
 2 ml **37-4001-02**
 5 ml **37-4001-05**
 10 ml **37-4001-10**
 20 ml **37-4001-20**
 50 ml **37-4001-50**



1 ml **37-4061-01**
 2 ml **37-4061-02**



LUER

1 ml **37-4050-01**
 2 ml **37-4050-02**
 5 ml **37-4050-05**
 10 ml **37-4050-10**
 20 ml **37-4050-20**
 50 ml **37-4050-50**



LUER-LOCK

1 ml **37-4000-01**
 2 ml **37-4000-02**
 5 ml **37-4000-05**
 10 ml **37-4000-10**
 20 ml **37-4000-20**
 50 ml **37-4000-50**



LUER-LOCK

2 ml **37-4055-02**
 5 ml **37-4055-05**
 10 ml **37-4055-10**



INSULIN LUER

1 ml **37-4060-01**
 2 ml **37-4060-02**

Spritzen
 Syringes
 Jeringas
 Siringhe

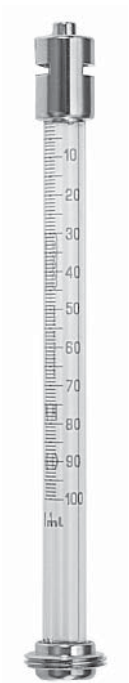

37-4066-01
 1 mm



50 ml **37-4071-05**
 100 ml **37-4071-10**
 150 ml **37-4071-15**
 200 ml **37-4071-20**



10 ml **37-4081-10**
 20 ml **37-4081-20**
 30 ml **37-4081-30**
 50 ml **37-4081-50**



TUBERKULIN
LUER-LOCK
37-4065-01
 1 mm



JANET

50 ml **37-4070-05**
 100 ml **37-4070-10**
 150 ml **37-4070-15**
 200 ml **37-4070-20**



LUER-LOCK

10 ml **37-4080-10**
 20 ml **37-4080-20**
 30 ml **37-4080-30**
 50 ml **37-4080-50**



TOOMEY
37-4100-50
 50 mm

Verbindungsstücke, Hähne
Connecting Pieces, Stopcocks
Piezas de conexión, Llaves
Raccordi, Rubinetti

Zwischenstück, LUER-LOCK weiblich
 Connecting piece, LUER-LOCK female
 Pieza de conexión, LUER-LOCK hembra
 Raccordo, LUER-LOCK femmina



37-4911-00

Zwischenstück, LUER-LOCK männlich
 Connecting piece, LUER-LOCK male
 Pieza de conexión, LUER-LOCK masculino
 Raccordo, LUER-LOCK maschio



37-4930-02

Zwischenstück, LUER-LOCK männlich
 Connecting piece, LUER-LOCK male
 Pieza de conexión, LUER-LOCK masculino
 Raccordo, LUER-LOCK maschio

Ø 6 mm

Ø 8 mm



37-4912-06



37-4912-08

Zwischenstück, LUER-LOCK weiblich
 Connecting piece, LUER-LOCK female
 Pieza de conexión, LUER-LOCK hembra
 Raccordo, LUER-LOCK femmina



37-4913-00

Zwischenstück, LUER-LOCK männlich
 Connecting piece, LUER-LOCK male
 Pieza de conexión, LUER-LOCK masculino
 Raccordo, LUER-LOCK maschio



37-4935-00

Durchflußhahn, LL männl. – LL weibl.
 Stopcock, LL male – LL female
 Llave, LL masculino – LL hembra
 Rubinetto, LL maschio – LL femmina



37-4939-00

Durchflußhahn, LL weiblich
 Stopcock, LL female
 Llave, LL hembra
 Rubinetto, LL femmina



37-4920-00

Dreiweghahn, 1 LL männl. – 2 LL weibl.
 Three-way-stopcock, 1 LL male – 2 LL female
 Llave de 3 vías, 1 LL masculino – 2 LL hembra
 Rubinetto a tre vie, 1 LL maschio – 2 LL femmina



37-4922-00

Dreiweghahn, 3 LL weiblich
 Three-way-stopcock, 3 LL female
 Llave de 3 vías, 3 LL hembra
 Rubinetto a tre vie, 3 LL femmina



37-4926-00

Galle, Leber, Niere, Blase, Urologie
Gall, Liver, Kidney, Bladder, Urology
Bilis, Hígado, Riñon, Vejiga, Urología
Bile, Fegato, Rene, Vescica, Urologia



Nierensteinzangen, Gallensteinzangen
Kidney Stone Forceps, Gall Stone Forceps
Pinzas para los cálculos renales, Pinzas para los cálculos biliares
Pinze per calcoli renali, Pinze per calcoli biliari



RANDALL

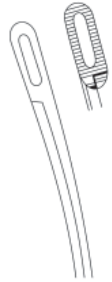

23,0 cm, 9"
51-4001-01

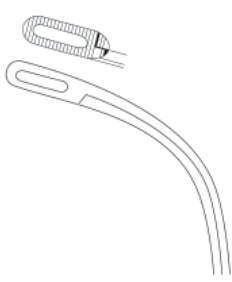

22,0 cm, 8⁵/₈"
51-4001-02

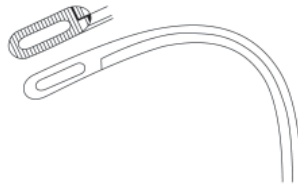

22,0 cm, 8⁵/₈"
51-4001-03



22,0 cm, 8⁵/₈"
51-4001-04



19,0 cm, 7¹/₂"
51-4001-05

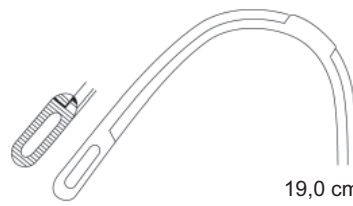

19,0 cm, 7¹/₂"
51-4001-06



DESJARDINS
23,0 cm, 9"



50-4001-01



50-4001-02



MIXTER
22,0 cm, 8⁵/₈"
50-4021-22



MAYO BLAKE
20,0 cm, 8"
50-4008-20



20,0 cm, 8"
50-4009-20

Gallensteinzangen
 Gall Stone Forceps
 Pinzas para los cálculos biliares
 Pinze per calcoli biliari

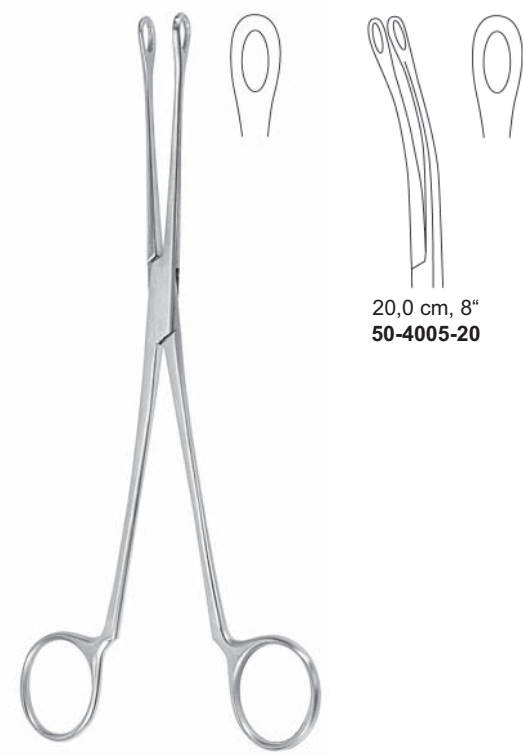

BLAKE
 20,0 cm, 8"
 50-4006-20

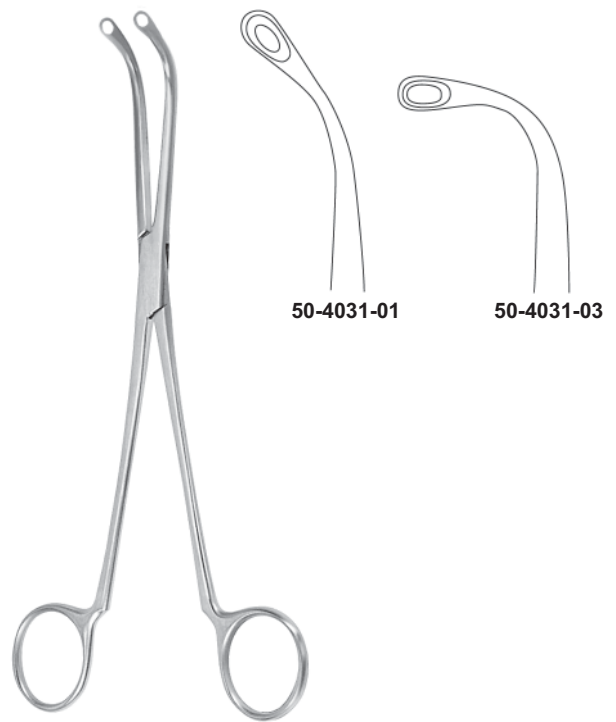

TURNER-WARWICK
 18,0 cm, 7"

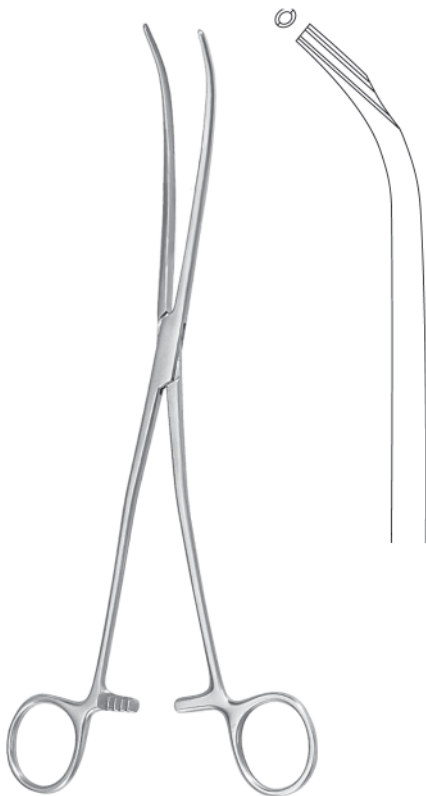

SÖKELAND
 24,0 cm, 9¹/₂"
 50-4037-24



CZERNY
 24,5 cm, 9⁵/₈"
 50-4039-24

Gallensteinlöffel
Gall Stone Scoops
Cucharillas para los cálculos biliares
Cucchiai per calcoli biliari



LUER-KÖRTE
 24,0 cm, 9½"

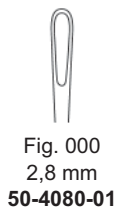

Fig. 000
 2,8 mm
50-4080-01

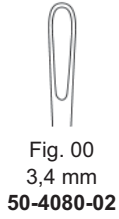

Fig. 00
 3,4 mm
50-4080-02



Fig. 2
 6,7 mm
50-4080-05



Fig. 3
 8,0 mm
50-4080-06

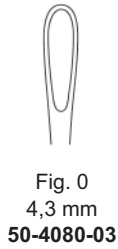

Fig. 0
 4,3 mm
50-4080-03



Fig. 1
 5,5 mm
50-4080-04



Fig. 4
 11,0 mm
50-4080-07



Fig. 5
 15,0 mm
50-4080-08



FERGUSSON
 21,5 cm, 8½"
50-4070-01



MAYO
 27,0 cm, 10⁵/₈"
50-4072-01



MAYO
 27,0 cm, 10⁵/₈"

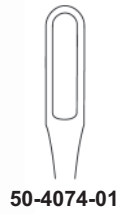

50-4074-01

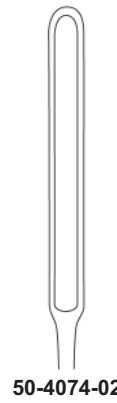

50-4074-02



MOYNIHAN
 34,0 cm, 13³/₈"
50-4076-34

Gallengangsonden, Gallengang Dilatoren
 Gall Duct Probes, Common Bile Duct Dilators
 Sonas p. el conducto biliar, Dilatadores para el conducto biliar
 Dilatori per condotti biliari, Dilatori per coledoco



MAYO
 32,0 cm, 12 1/2"
 50-4078-32



OCHSNER
 35,0 cm, 13 3/4"
 50-4082-35



DESJARDINS
 28,0 cm, 11"

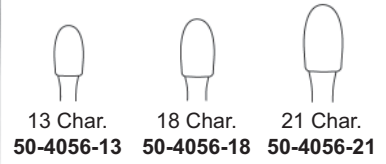

MOORE
 30,0 cm, 12"
 50-4084-30

Gallenblasenlöffel
 Gall bladder scoope
 Cuccharilla para la vesicula biliar
 Cucchiaio per colecisti



DESJARDINS
 28,0 cm, 11"



Gallengang Dilatatoren
Common Bile Duct Dilators
Dilatadores para el conducto biliar
Dilatatori per coledoco



Ø 1,0 mm
50-4050-01



Ø 2,0 mm
50-4050-02



Ø 3,0 mm
50-4050-03



Ø 4,0 mm
50-4050-04



Ø 5,0 mm
50-4050-05



Ø 6,0 mm
50-4050-06



Ø 7,0 mm
50-4050-07



Ø 8,0 mm
50-4050-08



Ø 9,0 mm
50-4050-09



Ø 10,0 mm
50-4050-10



Ø 11,0 mm
50-4050-11



Ø 12,0 mm
50-4050-12



Ø 13,0 mm
50-4050-13



BAKES
30,0 cm, 11³/₄"

**Blasenwundspreizer
Bladder Retractors
Deparadores para la vejiga
Divaricatori vescicali**

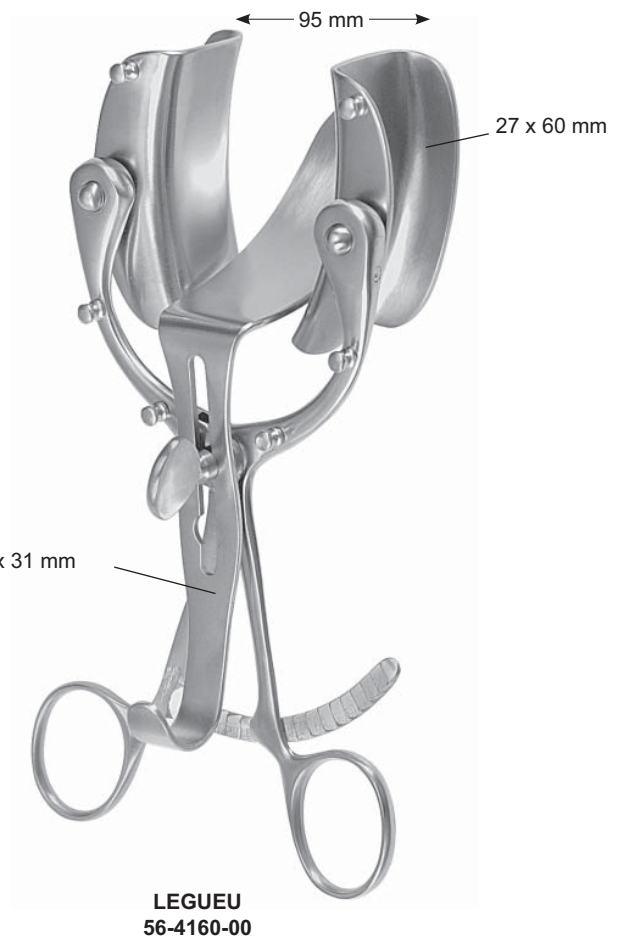
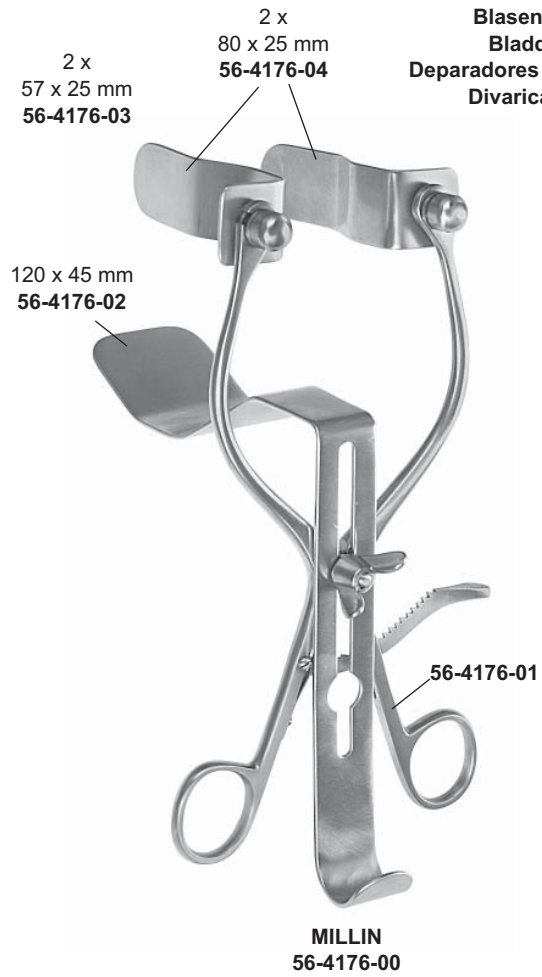

Instrumente für Prostatektomie
 Prostatectomy Instruments
 Instrumentos para la prostatectomía
 Strumenti per operazioni della prostata



MILLIN
 23,0 cm, 9"
 56-4073-23



ATRAUMA

MILLIN
 24,0 cm, 9½"
 56-4071-24

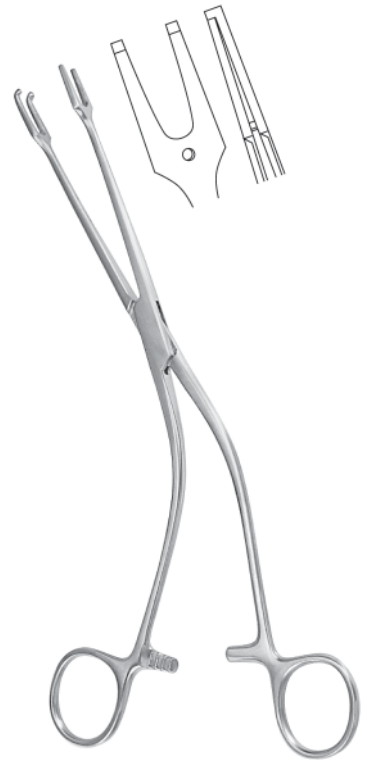

MILLIN
 24,0 cm, 9½"
 56-4077-24



MILLIN
 23,0 cm, 9"
 56-4075-23

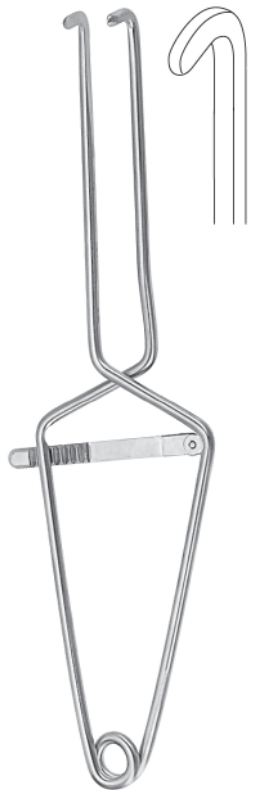

MILLIN
 28,5 cm, 11¼"
 56-4150-24

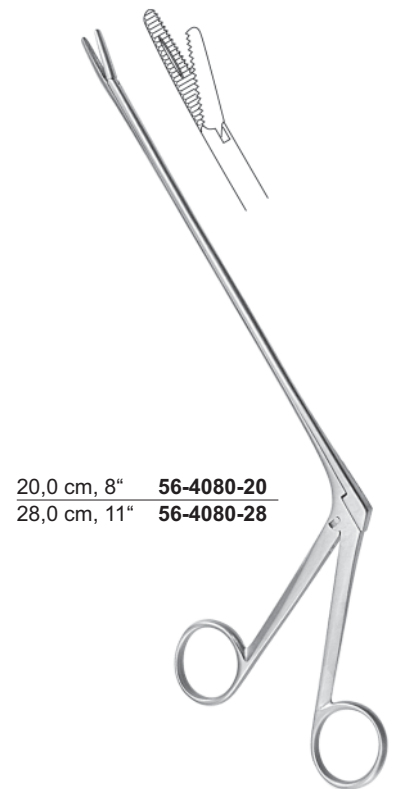

20,0 cm, 8" **56-4080-20**
 28,0 cm, 11" **56-4080-28**

MATHIEU

**Prostatahaken, Blasenspatel
Prostatic Retractors, Bladder Retractor
Separadores para la prostata, Separadores vesicales
Retrattori prostatici, Divaricatori vescicali**



YOUNG
21,0 cm, 8¹/₄"
56-4230-21



YOUNG
22,0 cm, 8⁵/₈"
56-4236-22



YOUNG
21,0 cm, 8¹/₄"
56-4238-21

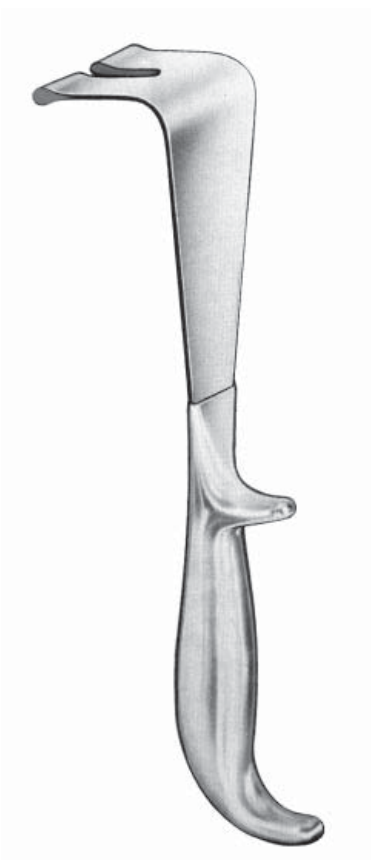

YOUNG
22,0 cm, 8⁵/₈"
56-4240-22



LEGUEU
26,0 cm, 10¹/₄"
56-4250-26



KOCHER
23,5 cm, 9¹/₄"
56-4257-23

Katheter, Penisklemmen
Catheters, Penis Clamp
Sondas, Compresor urétral
Cateteri, Serrapene



für Männer
 for men
 para hombres
 per uomini

Char. 8	56-4650-08
Char. 10	56-4650-10
Char. 12	56-4650-12
Char. 14	56-4650-14
Char. 16	56-4650-16
Char. 18	56-4650-18
Char. 20	56-4650-20
Char. 22	56-4650-22
Char. 24	56-4650-24

29,0 cm, 11¹/₂"



für Frauen
 for women
 para mujeres
 per donne

Char. 6	56-4660-06
Char. 7	56-4660-07
Char. 8	56-4660-08
Char. 9	56-4660-09
Char. 10	56-4660-10
Char. 11	56-4660-11
Char. 12	56-4660-12
Char. 13	56-4660-13
Char. 14	56-4660-14
Char. 15	56-4660-15
Char. 16	56-4660-16
Char. 18	56-4660-18
Char. 20	56-4660-20
Char. 24	56-4660-24

16,0 cm, 6¹/₄"



STRAUSS
 11,0 cm, 4¹/₃"
 56-4349-11



STOCKMANN
 8,0 cm, 3¹/₄"
 56-4345-08

Ø 8,0 mm	56-4350-08
Ø 11,0 mm	56-4350-11
Ø 13,0 mm	56-4350-13
Ø 16,0 mm	56-4350-16
Ø 21,0 mm	56-4350-21
Ø 26,0 mm	56-4350-26
Ø 32,0 mm	56-4350-32



COMCO

Magen, Darm, Mastdarm
Stomach, Intestines, Rectum
Estómago, Intestino, Recto
Stomaco, Intestino, Retto



Darm- und Gewebefäßzangen
Intestinal and Tissue Grasping Forceps
Pinzas intestinales y para tejidos
Pinze da presa per intestino e tessuti

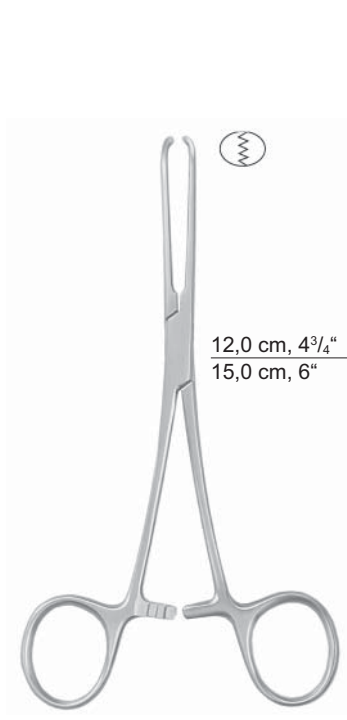

12,0 cm, 4³/₄" **52-4000-12**
 15,0 cm, 6" **52-4000-15**

ALLIS-BABY

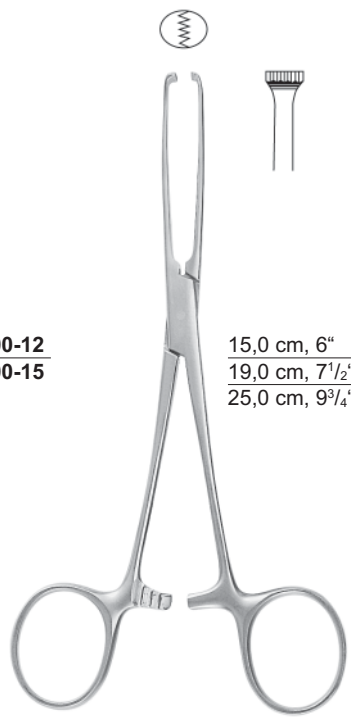

15,0 cm, 6" **52-4004-15**
 19,0 cm, 7¹/₂" **52-4004-19**
 25,0 cm, 9³/₄" **52-4004-25**

ALLIS

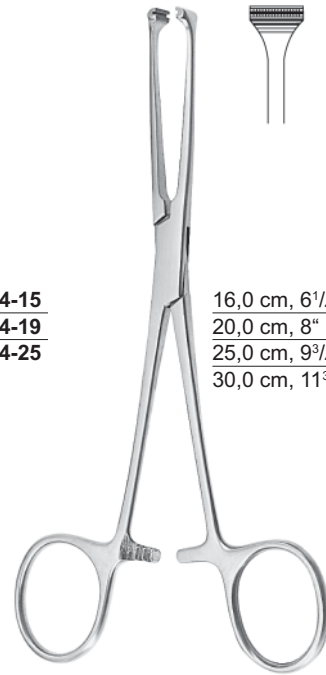

16,0 cm, 6¹/₄" **54-4124-16**
 20,0 cm, 8" **54-4124-20**
 25,0 cm, 9³/₄" **54-4124-25**
 30,0 cm, 11³/₄" **54-4124-30**

ALLIS-ATRAUMA



15,5 cm, 6" **52-4020-15**
 20,0 cm, 8" **52-4020-20**
 23,0 cm, 9" **52-4020-23**

ALLEN

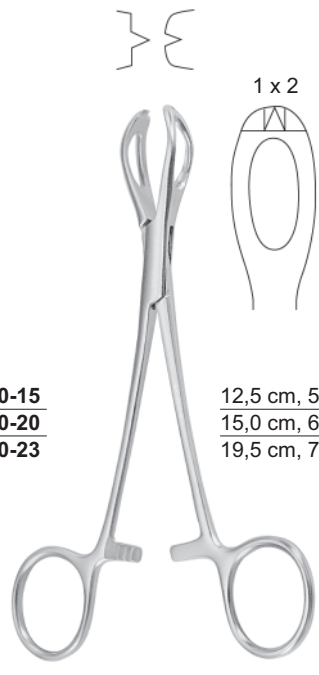

12,5 cm, 5" **52-4030-12**
 15,0 cm, 6" **52-4030-15**
 19,5 cm, 7³/₄" **52-4030-19**

LANE

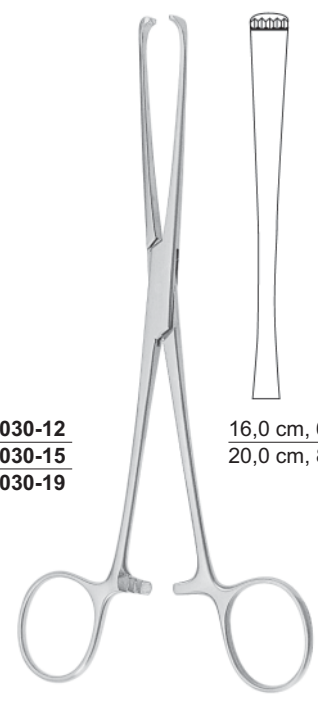

16,0 cm, 6¹/₄" **52-4178-16**
 20,0 cm, 8" **52-4178-20**

LOCKWOOD-ALLIS

Darm- und Gewebefäßzangen
 Intestinal and Tissue Grasping Forceps
 Pinzas intestinales y para tejidos
 Pinze da presa per intestino e tessuti



15,0 cm, 6" **52-4040-15**
 19,0 cm, 7½" **52-4040-19**

JUDD-ALLIS



2 x 3

LITTLEWOOD
 18,5 cm, 7¼"
52-4060-16



10 x 11

ALLIS-ADAIR
 15,5 cm, 6"
52-4010-15

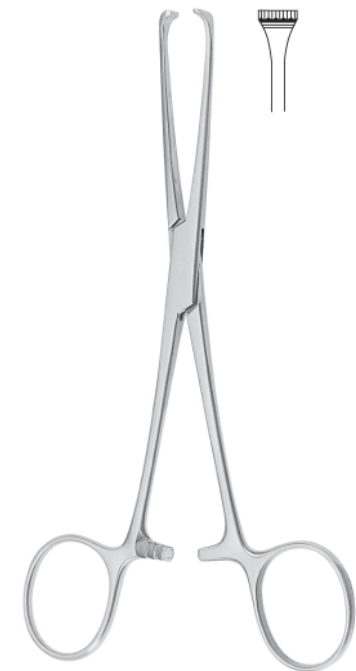

BOYS-ALLIS
 15,5 cm, 6"
52-4012-15



6 x 7

THOMS-ALLIS
 20,0 cm, 8"
52-4050-20



ALLIS
 20,0 cm, 8"
52-4014-20

Darm- und Gewebefäßzangen
Intestinal and Tissue Grasping Forceps
Pinzas intestinales y para tejidos
Pinze da presa per intestino e tessuti



LOCKWOOD
 20,0 cm, 8"
 52-4169-20

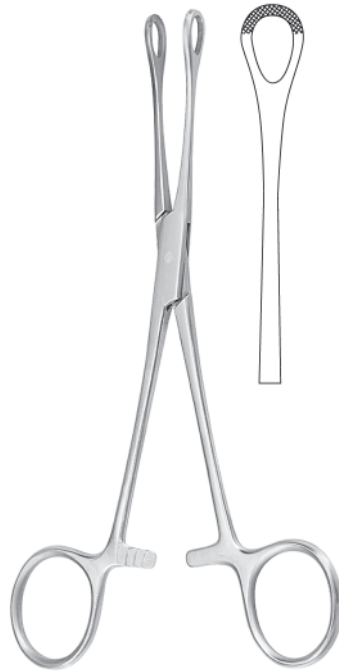

WILLIAMS
 16,0 cm, 6 1/4"
 52-4070-16



16,0 cm, 6 1/4" **52-4006-16**
 18,0 cm, 7" **52-4006-18**
 20,0 cm, 8" **52-4006-20**
 24,0 cm, 9 1/2" **52-4006-24**

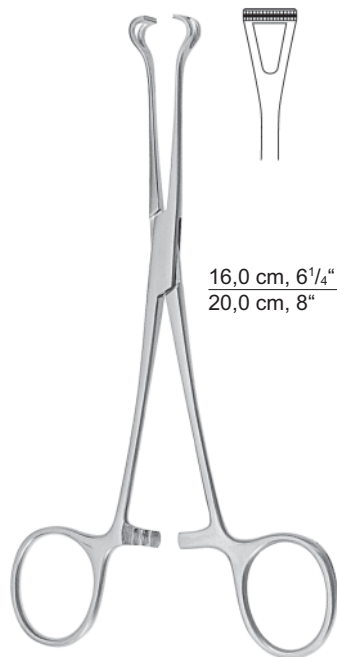

16,0 cm, 6 1/4" **54-4006-16**
 20,0 cm, 8" **54-4006-20**

BABCOCK-ATRAUMA



16,0 cm, 6 1/4" **53-4006-16**
 20,0 cm, 8" **53-4006-20**

BABCOCK-TC



DUVAL-TC
 20,0 cm, 8"
 53-4170-20

Darmklemmen
 Intestinal Clamp Forceps
 Pinzas-clamps intestinales
 Pinze intestinali

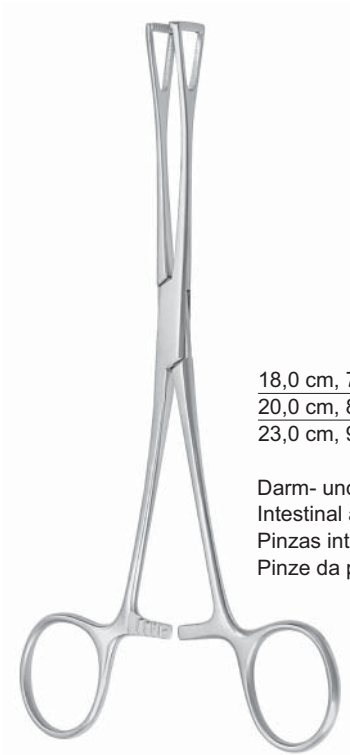

18,0 cm, 7" **52-4170-18**
 20,0 cm, 8" **52-4170-20** **52-4172-20**
 23,0 cm, 9" **52-4172-23**

Darm- und Gewebefaßzangen
 Intestinal and Tissue Grasping Forceps
 Pinzas intestinales y para tejidos
 Pinze da presa per intestino e tessuti

DUVAL



52-4200-18

52-4201-18

BABY-DOYEN
 18,0 cm, 7"



21,0 cm, 8 1/4" **52-4210-21**
 23,0 cm, 9" **52-4210-23**

21,0 cm, 8 1/4" **52-4211-21**
 23,0 cm, 9" **52-4211-23**

DOYEN

Darmklemmen
Intestinal Clamp Forceps
Pinzas-clamps intestinales
Pinze intestinali



DOYEN



21,0 cm, 8¹/₄" **54-4210-21**
 23,0 cm, 9" **54-4210-23**

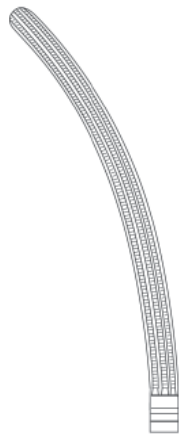

21,0 cm, 8¹/₄" **54-4211-21**
 23,0 cm, 9" **54-4211-23**

mit atraumatischer Zahnung
 with atraumatic serration
 con bacos atraumáticos
 con morsi atraumatici



KOCHER



22,0 cm, 8⁵/₈" **52-4234-22**
 25,0 cm, 9³/₄" **52-4234-25**
 28,0 cm, 11" **52-4234-28**



22,0 cm, 8⁵/₈" **52-4235-22**
 25,0 cm, 9³/₄" **52-4235-25**
 28,0 cm, 11" **52-4235-28**



mit atraumatischer Zahnung
 with atraumatic serration
 con bacos atraumáticos
 con morsi atraumatici



22,0 cm, 8⁵/₈" **54-4234-22**
 25,0 cm, 9³/₄" **54-4234-25**
 28,0 cm, 11" **54-4234-28**



22,0 cm, 8⁵/₈" **54-4235-22**
 25,0 cm, 9³/₄" **54-4235-25**
 28,0 cm, 11" **54-4235-28**

KOCHER



21,0 cm, 8¹/₄" **52-4230-21**
 23,0 cm, 9" **52-4230-23**
 25,0 cm, 9³/₄" **52-4230-25**



21,0 cm, 8¹/₄" **52-4231-21**
 23,0 cm, 9" **52-4231-23**
 25,0 cm, 9³/₄" **52-4231-25**

MAYO-ROBSON

Darmklemmen
Intestinal Clamp Forceps
Pinzas-clamps intestinales
Pinze intestinali



21,0 cm, 8¹/₄" **54-4230-21**
 23,0 cm, 9" **54-4230-23**
 25,0 cm, 9³/₄" **54-4230-25**

mit atraumatischer Zahnung
 with atraumatic serration
 con bacos atraumáticos
 con morsi atraumatici

MAYO-ROBSON

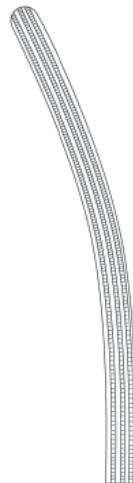

21,0 cm, 8¹/₄" **54-4231-21**
 23,0 cm, 9" **54-4231-23**
 25,0 cm, 9³/₄" **54-4231-25**

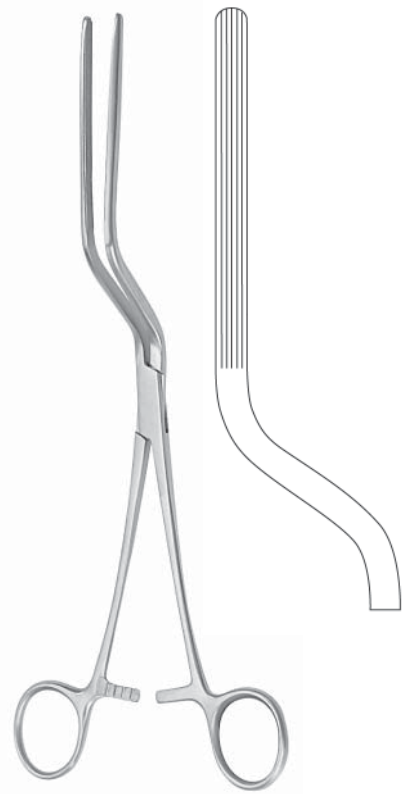

BRUNNER
 24,0 cm, 9¹/₂"
52-4240-24

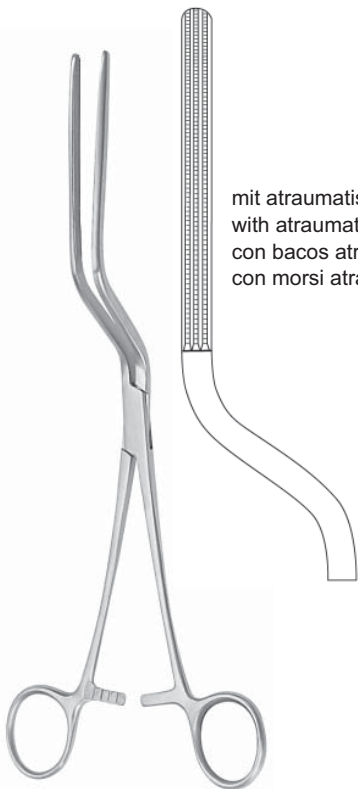

mit atraumatischer Zahnung
 with atraumatic serration
 con bacos atraumáticos
 con morsi atraumatici

BRUNNER
 24,0 cm, 9¹/₂"
54-4240-24

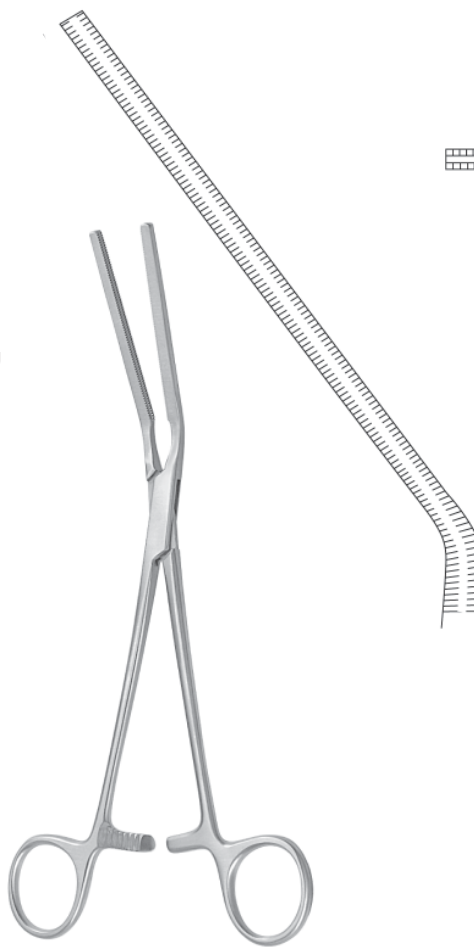

GLASSMAN
 23,0 cm, 9"
52-4259-23



GLASSMAN
 23,5 cm, 9¹/₄"
52-4253-23

Darm- und Magenquetschklemmen
 Intestinal and Stomach Clamps
 Pinzas-clamps intestinales y estomacales
 Pinze/Clamp per intestino e stomaco



Maullänge
 length of jaws
 longitud de la boca
 bocche lungh.

5,0 cm, 2" **52-4320-05**
 7,0 cm, 2 1/2" **52-4320-07**
 10,0 cm, 4" **52-4320-10**

DE MARTEL-WOLFSON



DE MARTEL-WOLFSON
 8,5 cm, 3 1/2"
52-4340-08



DE MARTEL-WOLFSON
 26,0 cm, 10 1/4"
52-4325-26



BABY-PAYR
 15,0 cm, 6"



52-4310-15
 mit Stift
 with pin
 con espiga
 con perno



52-4311-15
 ohne Stift
 without pin
 sin espiga
 senza perno



PAYR



21,0 cm, 8 1/4"
 29,0 cm, 11 1/2"

mit Stift
 with pin
 con espiga
 con perno



52-4310-21 **52-4311-21**
52-4310-29 **52-4311-29**

ohne Stift
 without pin
 sin espiga
 senza perno

Darm- und Magenklappen
 Intestinal and Stomach Clamp Forceps
 Pinzas-clamps intestinales y estomacales
 Pinze per intestino e stomaco



52-4360-30

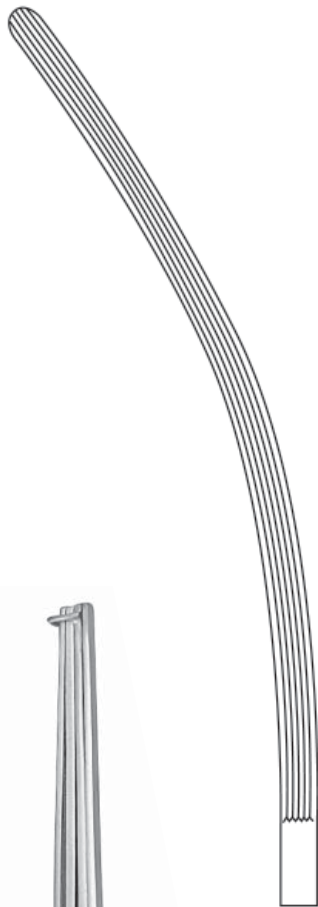

52-4361-30

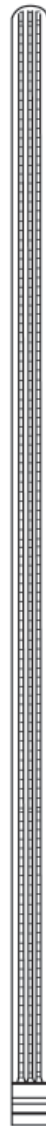

52-4364-33

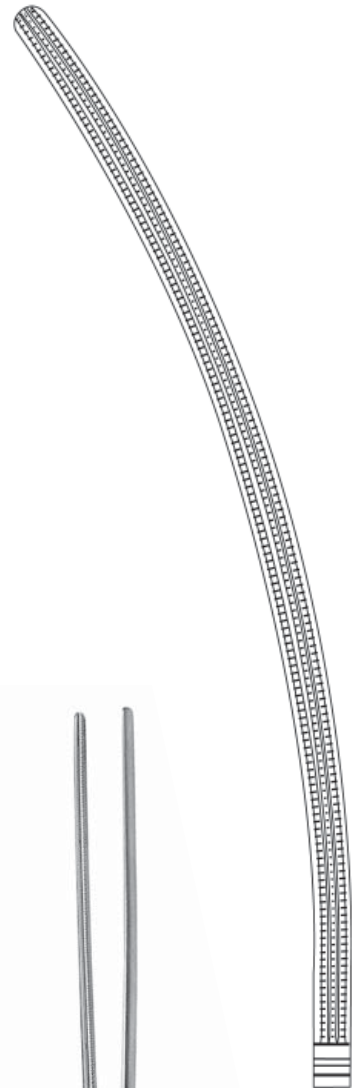

52-4365-33

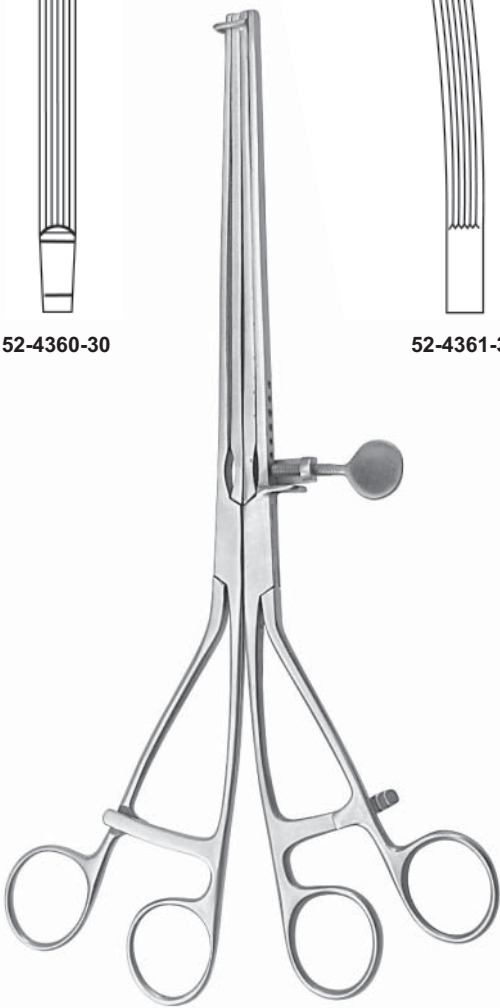

LANE
 30,0 cm, 11³/₄"

mit atraumatischer Zahnung
 with atraumatic serration
 con bacos atraumáticas
 con morsi atraumatici



SCUDDER
 33,0 cm, 13"

Rektum-Anastomosenklemmen
Sigmoid Anastomosis Forceps
Pinzas para anastomosis de recto
Pinze per anastomosi de retto



MIKULICZ
19,0 cm, 7½"
55-4010-19

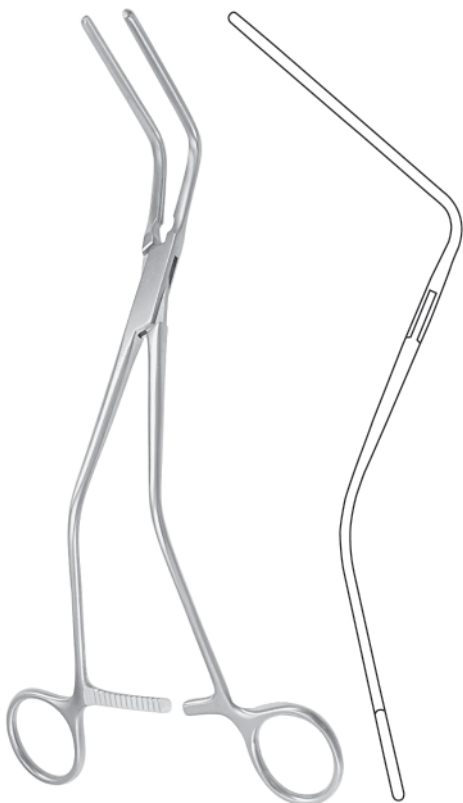

HAYES

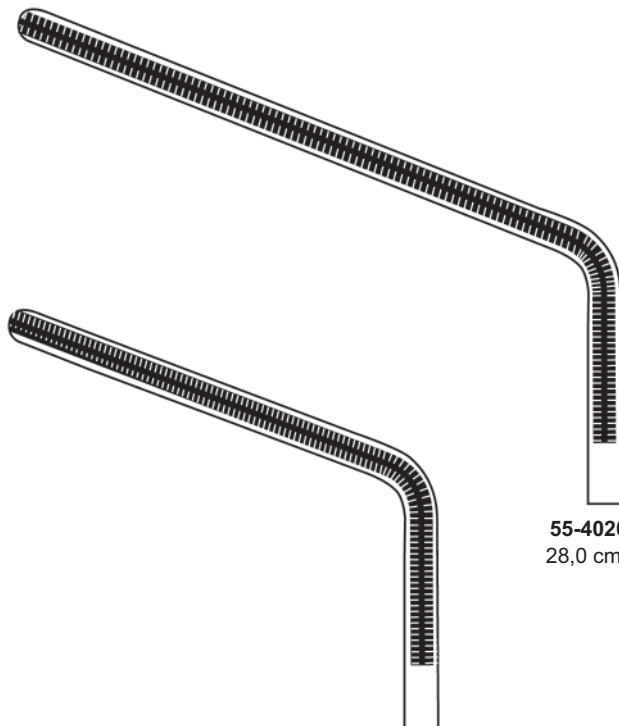

55-4020-28
28,0 cm, 11"

55-4020-26
26,0 cm, 10"

Mastdarm-Rektum-Spekula
Rectal Specula
Espéculos para el recto
Speculi rectali

17 x 89 mm



SIMS
15,0 cm, 6"
55-4108-15

17 x 89 mm



SIMS
15,0 cm, 6"
55-4110-15

25 x 89 mm



MATHIEU
21,0 cm, 8 1/4"
55-4150-21

75 x 23 mm



SMITH-BUIE
15,0 cm, 6"
55-4160-15

Anal spreizer, Sphinkterskope, Anuskope
Rectal Retractor, Sphincteroscopes, Anoscope
Separadores para el recto, Esfinteroscopios, Anoscopios
Dilatatori per l'ano ed il retti, Sfinteroscopi, Anoscopi

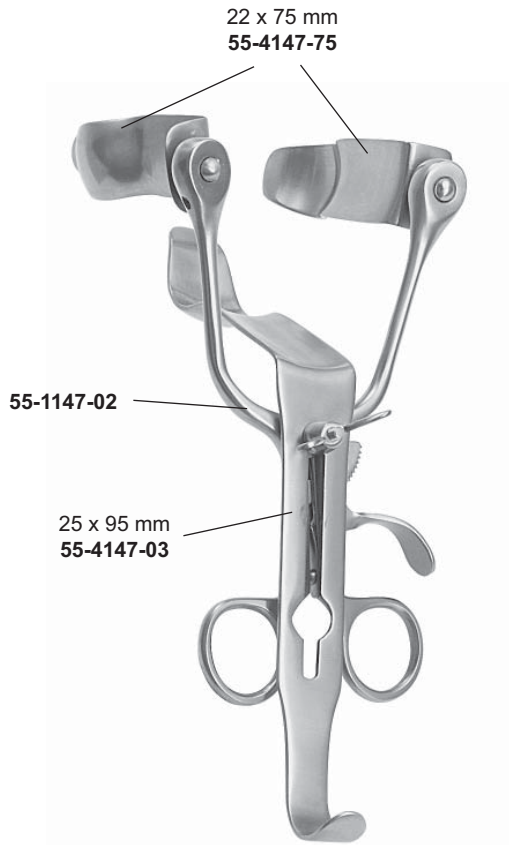

ALAN PARKS
 13,5 cm, 5³/₈"
 55-4147-00



Kaltlichtkammer für Proktoskope
 Cold-light clip for proctoscopes
 Clip para luz fria con proctoscopios
 Clip per luce fredda con protoscopi

55-4200-00

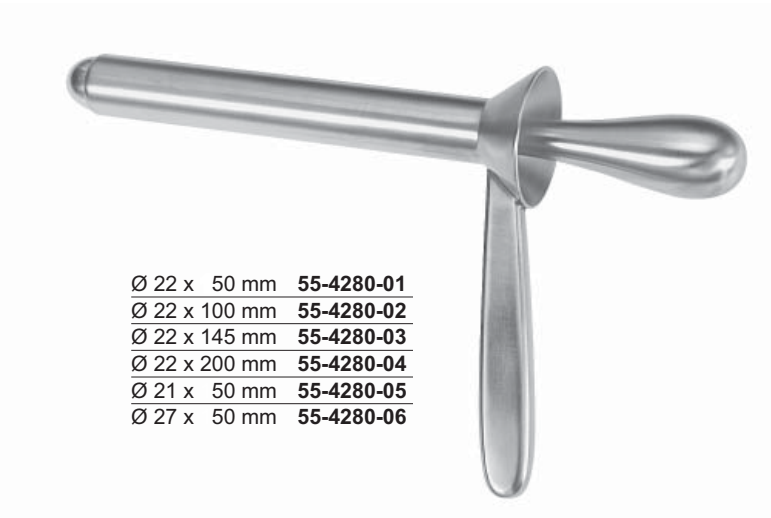

HAYES

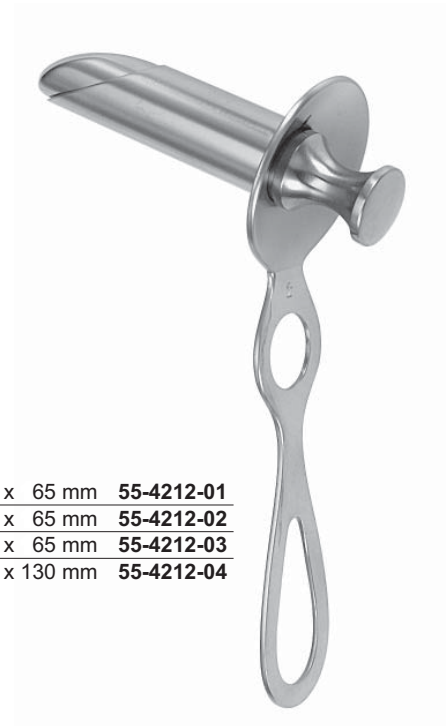

HIRSCHMANN

Anuskope, Proktoskope
 Anoscope, Proctoscopes
 Anoscopios, Proctoscopios
 Anoscopi, Protoscopi



Ø 22 x 65 mm **55-4250-22**
 Ø 30 x 65 mm **55-4250-30**

CHELSEA EATON



ohne Kaltlichtträger
 without cold light carrier
 sin portador para luz fría
 senza luce fredda

IVES FANSLER
 Ø 22 mm
55-4268-01

mit Kaltlichtträger
 with cold light carrier
 con portador para luz fría
 con luce fredda

IVES FANSLER
 Ø 22 mm
55-4268-02



Ø 17 x 65 mm **55-4220-01**
 Ø 17 x 80 mm **55-4220-02**
 Ø 20 x 65 mm **55-4220-03**
 Ø 20 x 80 mm **55-4220-04**
 Ø 24 x 65 mm **55-4220-05**
 Ø 24 x 80 mm **55-4220-06**

55-4000-02

MORGAN

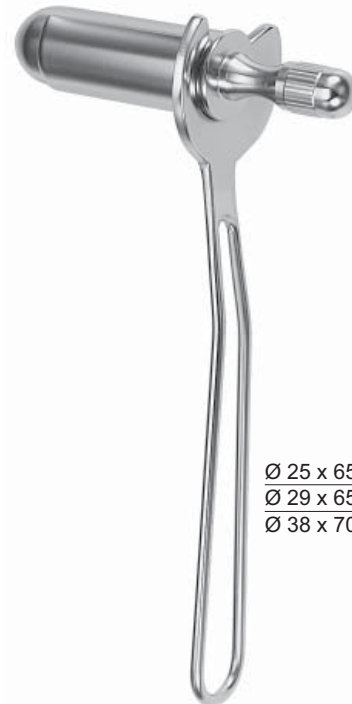

Ø 25 x 65 mm **55-4124-25**
 Ø 29 x 65 mm **55-4124-29**
 Ø 38 x 70 mm **55-4124-38**

FANSLER

Mastdarm-Biopsiezangen
Rectal Biopsy Forceps
Pinzas sacabocado para biopsia rectal
Pinze taglianti per biopsia rettale



28,0 cm, 11"	55-4300-28
35,0 cm, 13 ³ / ₄ "	55-4300-35
42,0 cm, 16 ¹ / ₂ "	55-4300-42

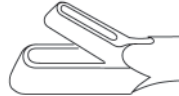

28,0 cm, 11"	55-4311-28
35,0 cm, 13 ³ / ₄ "	55-4311-35
42,0 cm, 16 ¹ / ₂ "	55-4311-42

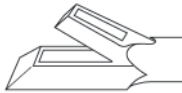

28,0 cm, 11"	55-4301-28
35,0 cm, 13 ³ / ₄ "	55-4301-35
42,0 cm, 16 ¹ / ₂ "	55-4301-42

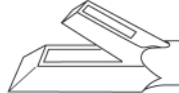

28,0 cm, 11"	55-4312-28
35,0 cm, 13 ³ / ₄ "	55-4312-35
42,0 cm, 16 ¹ / ₂ "	55-4312-42



55-4405-12

Ø 12,0 mm

Hämorrhoiden-Ligator mit Ladekonus
 Haemorrhoidal ligator with loading attachment
 Ligador para hemorroides con cono de carga
 Legatori emorroidali con carica a cono

RUDD
55-4400-00

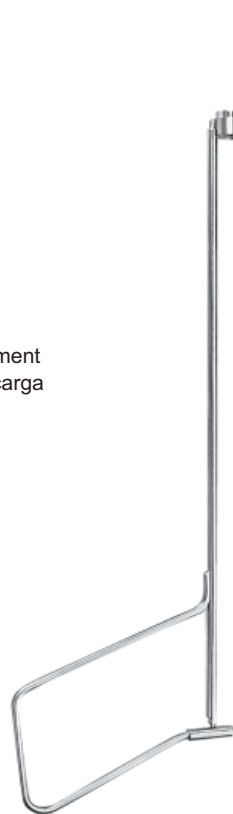

55-4405-12

Ø 12,0 mm

Hämorrhoiden-Ligator mit Ladekonus
 Haemorrhoidal ligator with loading attachment
 Ligador para hemorroides con cono de carga
 Legatori emorroidali con carica a cono

MC GIVNEY
55-4410-00

Hämorrhoiden-Faßzangen, Fistelsonden
Haemorrhoidal Forceps, Fistula probes
Pinza-clamps para hemorroides, Sondas para fistula
Pinze per emorroidi, Sonde per fistola



MC GIVNEY
19,0 cm, 7 1/2"
55-4471-19



MC GIVNEY
19,0 cm, 7 1/2"
55-4473-19



PRATT
21,0 cm, 8 1/4"



33-4135-01



33-4135-02



33-4135-03

Gynäkologie, Geburtshilfe
Gynecology, Obstetrics
Ginecología, Obstetricia
Ginecologia, Ostetricia



Scheidenspekula
Vaginal Specula
Espéculos vaginales
Speculi vaginali

für Jungfrauen
 for virgins
 para vírgenes
 per vergini

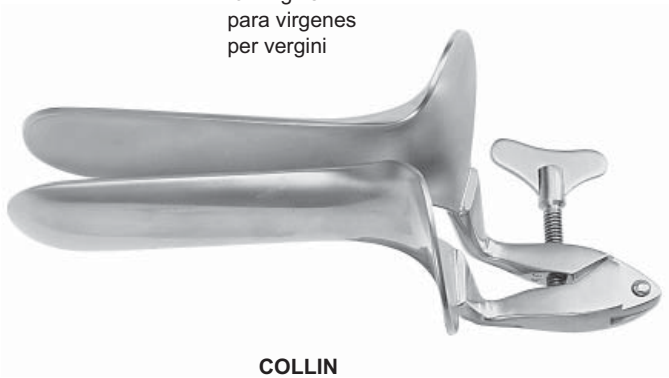

COLLIN
 65 x 10 mm
57-4132-00

für Kinder
 for children
 para niños
 per bambini



COLLIN
 65 x 10 mm
57-4134-00



COLLIN
 85 x 30 mm **57-4130-01**
 100 x 35 mm **57-4130-02**
 110 x 40 mm **57-4130-03**



80 x 24 mm **57-4142-01**
 80 x 32 mm **57-4142-02**
 98 x 16 mm **57-4142-03**
 105 x 25 mm **57-4142-04**
 107 x 29 mm **57-4142-05**
 115 x 35 mm **57-4142-06**

**Scheidenspekula
Vaginal Specula
Espéculos vaginales
Speculi vaginali**

zentrale Stellschraube
central fixation screw
tornillo de sujeto central
vite di regolazione centrale



CUSCO

75 x 32 mm	57-4144-01
85 x 36 mm	57-4144-02
95 x 37 mm	57-4144-03

seitliche Stellschraube
lateral fixation screw
tornillo de sujeto lateral
vite di regolazione laterale

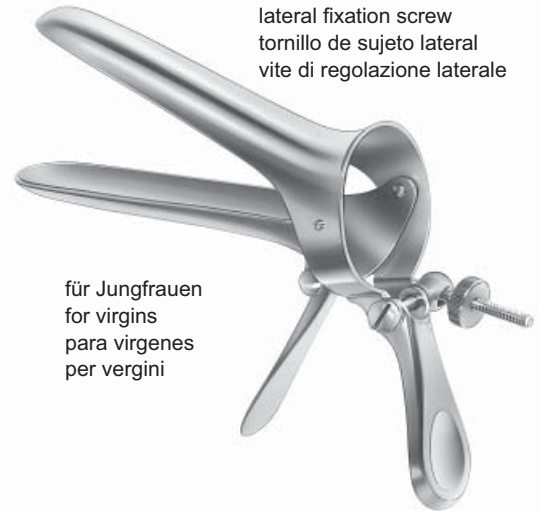

für Jungfrauen
for virgins
para virgenes
per vergini

CUSCO

75 x 17 mm	57-4140-00
------------	-------------------

seitliche Stellschraube
lateral fixation screw
tornillo de sujeto lateral
vite di regolazione laterale



CUSCO

75 x 32 mm	57-4140-01
85 x 35 mm	57-4140-02
100 x 35 mm	57-4140-03

Schweizer Modell
Swiss pattern
Modelo suizo
Modello svizzero



CUSCO

90 x 23-25 mm	57-4146-01
100 x 25-27 mm	57-4146-02
110 x 27-30 mm	57-4146-03

Scheidenspekula
 Vaginal Specula
 Espéculos vaginales
 Speculi vaginali



GRAVE

75 x 20 mm	57-4100-01
95 x 35 mm	57-4100-02
115 x 35 mm	57-4100-03



PEDERSON

75 x 13 mm	57-4120-01
100 x 22 mm	57-4120-02
120 x 25 mm	57-4120-03



SEMM

90 x 14-18 mm	57-4150-01
100 x 17-20 mm	57-4150-02
100 x 25-30 mm	57-4150-03



WEISSBARTH

21,0 cm, 8 1/4"
57-4160-00

**Scheidenspekula
Vaginal Specula
Espéculos vaginales
Speculi vaginali**



mit abnehmbarem Gewicht
with detachable weight
con peso desmontable
con peso smontabile

1,14 kg

AUVARD
75 x 38 mm
57-4170-00



mit festem Gewicht
with fixed weight
con peso fijo
con peso fisso

1,14 kg

AUVARD
75 x 38 mm
57-4172-00



57-4180-03

400 g
57-4180-40

800 g
57-4180-80

SCHERBACK
57-4180-00

koplett, complete, completo, completo

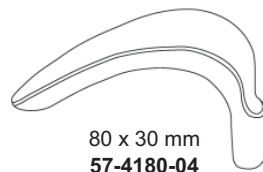

80 x 30 mm
57-4180-04

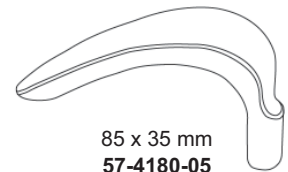

85 x 35 mm
57-4180-05

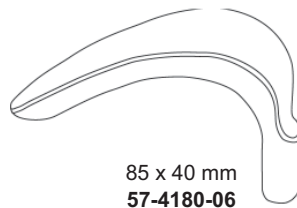

85 x 40 mm
57-4180-06

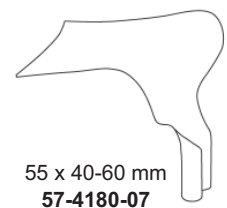

55 x 40-60 mm
57-4180-07



70 x 45-70 mm
57-4180-08

Scheidenspekula
 Vaginal Specula
 Espéculos vaginales
 Speculi vaginali



Satz
 Set
 Juego
 Set

KRISTELLER

Fig. 1 **57-4220-01**
 Fig. 2 **57-4220-02**
 Fig. 3 **57-4220-03**

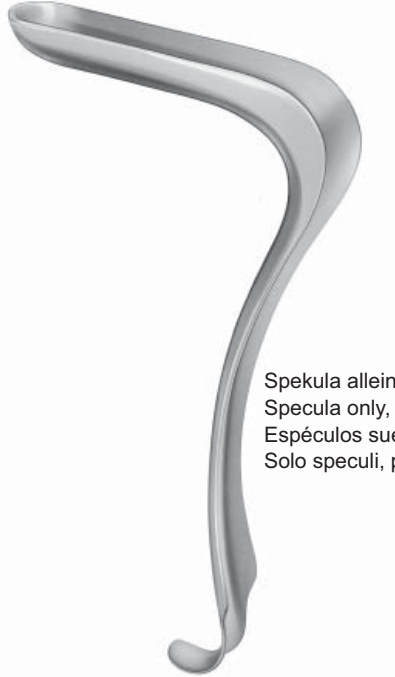

Spekula allein, flach
 Specula only, flat hollow
 Espéculos suelto, con huecos planos
 Solo speculi, piatta

KRISTELLER

105 x 26 mm **57-4221-01**
 105 x 28 mm **57-4221-02**
 105 x 33 mm **57-4221-03**



Halter allein
 Retractors only
 Valvas suelto
 Solo valve

KRISTELLER

115 x 22 mm **57-4222-01**
 115 x 24 mm **57-4222-02**
 115 x 29 mm **57-4222-03**



Satz
 Set
 Juego
 Set

KRISTELLER

Fig. 1 **57-4230-01**
 Fig. 2 **57-4230-02**
 Fig. 3 **57-4230-03**



Spekula allein, flach
 Specula only, flat hollow
 Espéculos suelto, con huecos planos
 Solo speculi, piatta

KRISTELLER

110 x 27 mm **57-4231-01**
 110 x 30 mm **57-4231-02**
 110 x 36 mm **57-4231-03**

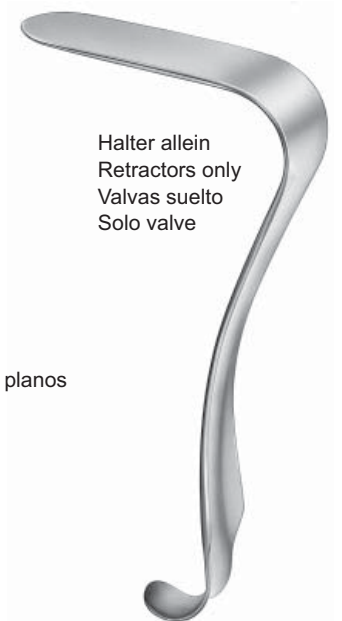

Halter allein
 Retractors only
 Valvas suelto
 Solo valve

KRISTELLER

115 x 23 mm **57-4232-01**
 115 x 26 mm **57-4232-02**
 115 x 32 mm **57-4232-03**

Scheidenspekula
Vaginal Specula
Espéculos vaginales
Speculi vaginali



Satz
Set
Juego
Set

KRISTELLER

Fig. 0 **57-4234-00**
Fig. 1 **57-4234-01**
Fig. 2 **57-4234-02**
Fig. 3 **57-4234-03**



Spekula allein
Specula only
Espéculos suelto
Solo speculi

KRISTELLER

70 x 15 mm **57-4235-00**
70 x 27 mm **57-4235-01**
80 x 30 mm **57-4235-02**
90 x 36 mm **57-4235-03**

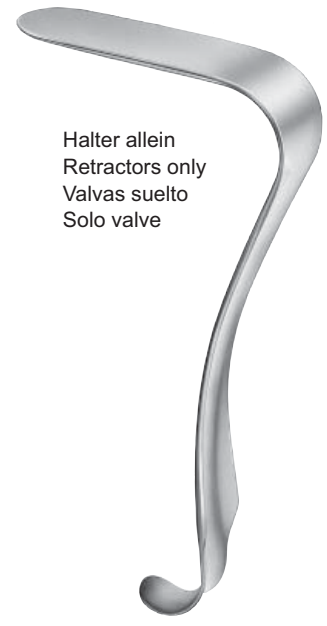

Halter allein
Retractors only
Valvas suelto
Solo valve

KRISTELLER

75 x 10 mm **57-4236-00**
75 x 23 mm **57-4236-01**
85 x 26 mm **57-4236-02**
100 x 32 mm **57-4236-03**



konisch, für Jungfrauen
conical blades, for virgins
valvos cónicos, para vírgenes
valve coniche, per vergini

Satz
Set
Juego
Set

KRISTELLER

Fig. 00 **57-4237-01**
Fig. 0 **57-4237-02**



Spekula allein
Specula only
Espéculos suelto
Solo speculi

KRISTELLER

105 x 18 mm **57-4238-01**
105 x 21 mm **57-4238-02**



Halter allein
Retractors only
Valvas suelto
Solo valve

KRISTELLER

110 x 14 mm **57-4239-01**
110 x 17 mm **57-4239-02**

Scheidenspekula
 Vaginal Specula
 Espéculos vaginales
 Speculi vaginali



leicht hohl
 slightly-concave
 ligeremente concavos
 leggeremente concavi

Fig	a x b	
1	55 x 35 mm	57-4260-01
2	85 x 35 mm	57-4260-02
3	115 x 35 mm	57-4260-03
<hr/>		
1	55 x 45 mm	57-4261-01
2	85 x 45 mm	57-4261-02
3	115 x 45 mm	57-4261-03
4	160 x 45 mm	57-4261-04
<hr/>		
1	55 x 60 mm	57-4262-01
2	85 x 60 mm	57-4262-02
3	115 x 60 mm	57-4262-03
4	160 x 60 mm	57-4262-04

DOYEN
 23,0 cm, 9"

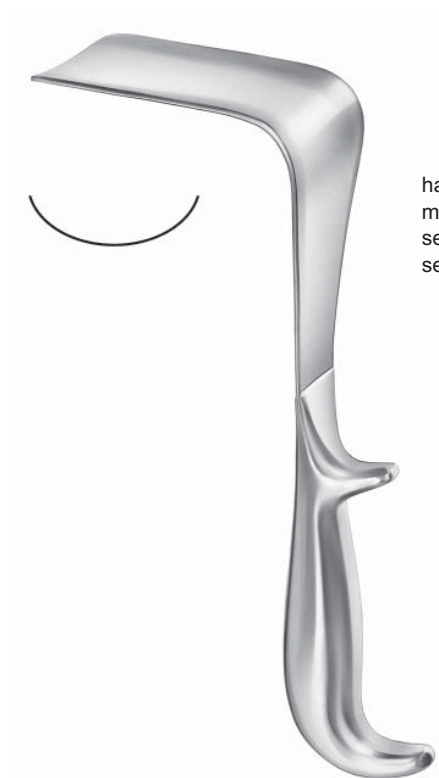

halb-hohl
 medium-concave
 semi-concavos
 semi-concavi

Fig	a x b	
1	55 x 35 mm	57-4264-01
2	85 x 35 mm	57-4264-02
3	115 x 35 mm	57-4264-03
<hr/>		
1	55 x 45 mm	57-4265-01
2	85 x 45 mm	57-4265-02
3	115 x 45 mm	57-4265-03
<hr/>		
1	55 x 60 mm	57-4266-01
2	85 x 60 mm	57-4266-02
3	115 x 60 mm	57-4266-03

DOYEN
 23,0 cm, 9"

Scheidenspekula
Vaginal Specula
Espéculos vaginales
Speculi vaginali



Satz
Set
Juego
Set

KALLMORGEN

70 x 40 mm **57-4270-01**
90 x 40 mm **57-4270-02**



Spekula allein
Specula only
Espéculos suelto
Solo speculi

KALLMORGEN

70 x 40 mm **57-4271-01**
90 x 40 mm **57-4271-02**



Halter allein
Retractors only
Valvas suelto
Solo valve

KALLMORGEN

70 x 40 mm **57-4272-01**
90 x 40 mm **57-4272-02**



70 x 15 mm

KRISTELLER

17,0 cm, 6³/₄"
57-4275-17



75 x 39 mm

KALLMORGEN

17,0 cm, 6³/₄"
57-4290-17



JACKSON

75 x 38 mm **57-4290-01**
90 x 38 mm **57-4290-02**
100 x 38 mm **57-4290-03**

Scheidenspekula
Vaginal Specula
Espéculos vaginales
Speculi vaginali

76 x 25 mm



70 x 22 mm

BREISKY
14,0 cm, 5½"
57-4292-01

82 x 30 mm



76 x 25 mm

BREISKY
14,0 cm, 5½"
57-4292-02

95 x 38 mm



82 x 30 mm

BREISKY
17,0 cm, 6¾"
57-4292-03

102 x 44 mm



95 x 38 mm

BREISKY
17,0 cm, 6¾"
57-4292-04

Scheidenspekula und -halter
Vaginal Specula and Retractors
Espéculos y valvas vaginales
Speculi e valve vaginali

SIMS
57-4294-00
 Satz, Set, Juego, Set

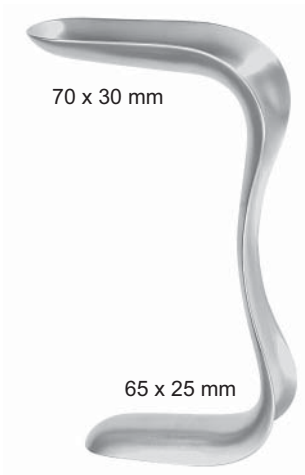

SIMS
 12,5 cm, 5"
57-4294-01



SIMS
 15,0 cm, 6"
57-4294-02

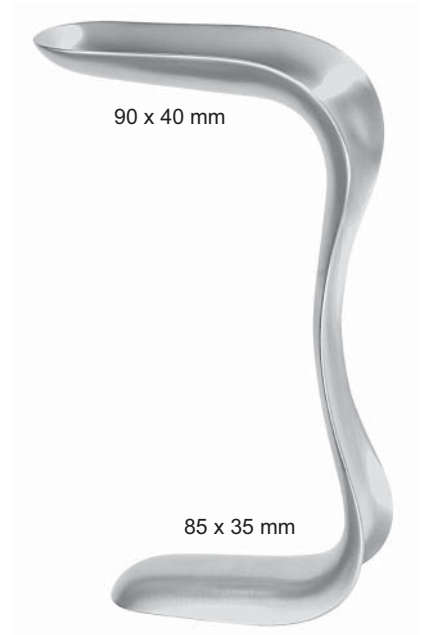

SIMS
 17,5 cm, 7"
57-4294-03



Spekula allein
 Specula only
 Espéculos suelto
 Solo speculi

MATHIEU
 100 x 13-23 mm **57-4300-01**
 100 x 16-30 mm **57-4300-02**



Halter allein
 Retractors only
 Valvas suelto
 Solo valve

MATHIEU
 100 x 11-21 mm **57-4301-01**
 100 x 14-27 mm **57-4301-02**



LANDAU
 100 x 28 mm **57-4305-01**
 100 x 38 mm **57-4305-02**

Scheidenspekula
 Vaginal Specula
 Espéculos vaginales
 Speculi vaginali



100 x 20 mm	57-4307-20
100 x 25 mm	57-4307-25
100 x 30 mm	57-4307-30
100 x 35 mm	57-4307-35
100 x 40 mm	57-4307-40
<hr/>	
130 x 20 mm	57-4308-20
130 x 25 mm	57-4308-25
130 x 30 mm	57-4308-30
130 x 35 mm	57-4308-35
130 x 40 mm	57-4308-40
<hr/>	
155 x 40 mm	57-4309-40

BREISKY

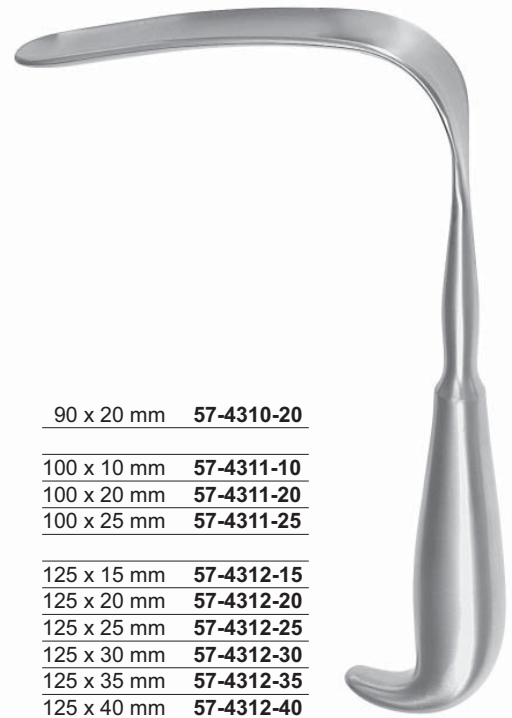

90 x 20 mm	57-4310-20
<hr/>	
100 x 10 mm	57-4311-10
100 x 20 mm	57-4311-20
100 x 25 mm	57-4311-25
<hr/>	
125 x 15 mm	57-4312-15
125 x 20 mm	57-4312-20
125 x 25 mm	57-4312-25
125 x 30 mm	57-4312-30
125 x 35 mm	57-4312-35
125 x 40 mm	57-4312-40

MATZENAUER



BRAUN, MODIF.
 19,0 cm, 7½"
57-4313-19



DOYEN
 23,0 cm, 9"
57-4315-23



DOYEN
 25,0 cm, 9"
57-4315-25



WERTHEIM
 30,0 cm, 12"
57-4317-30

**Endospekula, Lateral-Spekulum, Intrauterinsonde
 Endospecula, Lateral Speculum, Intrauterine Probe
 Endoespéculos, Espéculo lateral, Sonda intra-uterina
 Endospeculi, Speculo lateral, Sonde intrauterine**

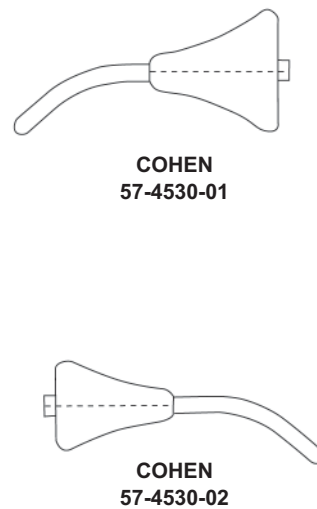
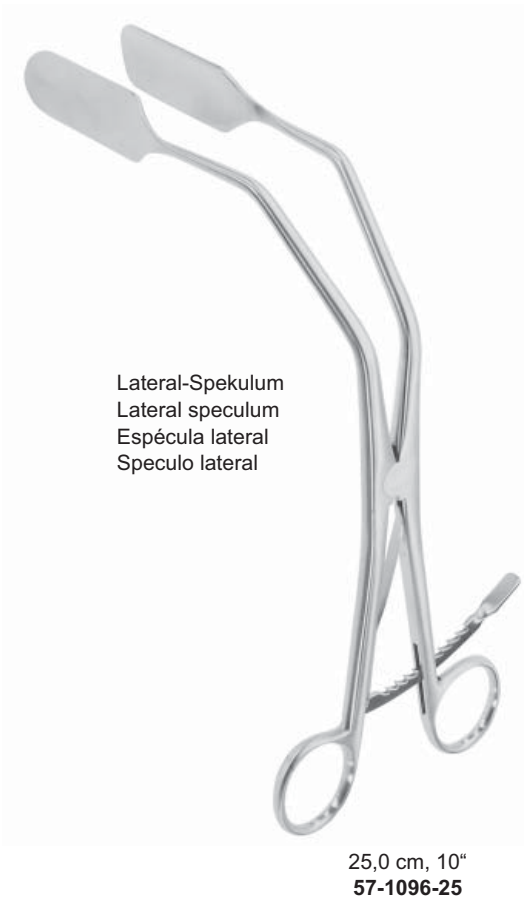
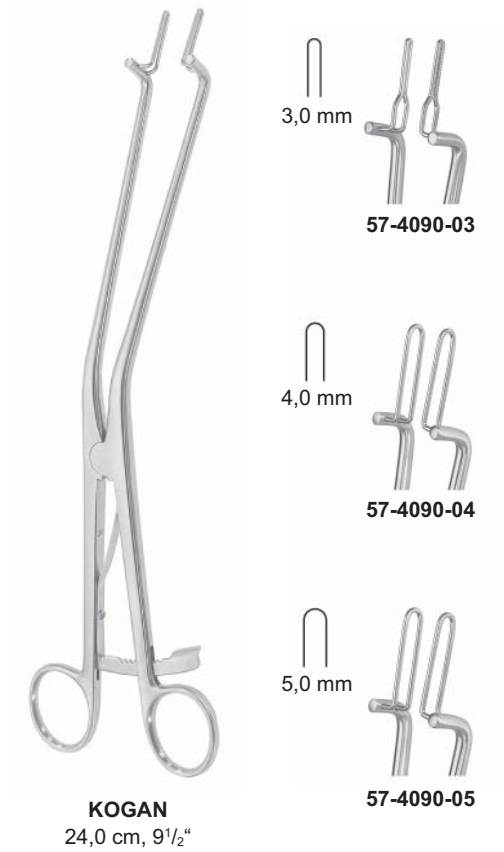
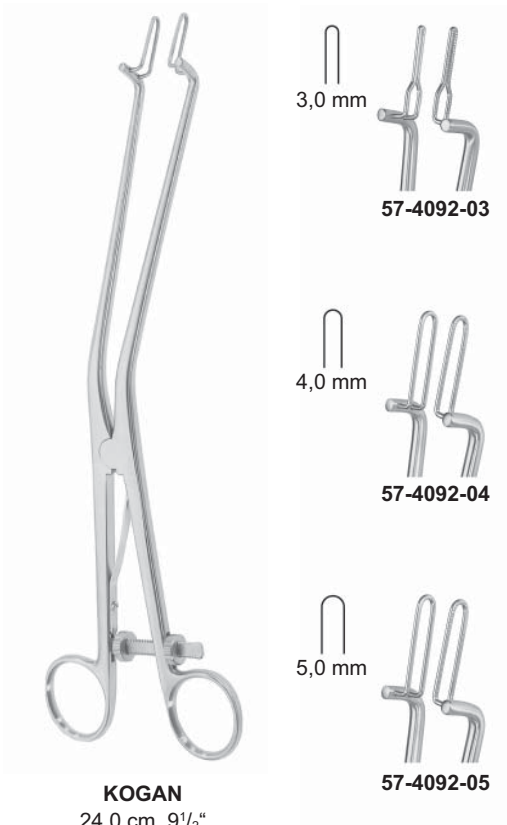

Uterus-Dilatatoren
Uterine Dilators
Dilatadores uterinos
Dilatatori uterini



HEGAR
 18,5 cm, 7¹/₄"

Ø 1,0 mm	57-4350-01
Ø 2,0 mm	57-4350-02
Ø 3,0 mm	57-4350-03
Ø 4,0 mm	57-4350-04
Ø 5,0 mm	57-4350-05
Ø 6,0 mm	57-4350-06
Ø 7,0 mm	57-4350-07
Ø 8,0 mm	57-4350-08
Ø 9,0 mm	57-4350-09
Ø 10,0 mm	57-4350-10
Ø 11,0 mm	57-4350-11
Ø 12,0 mm	57-4350-12
Ø 13,0 mm	57-4350-13
Ø 14,0 mm	57-4350-14
Ø 15,0 mm	57-4350-15
Ø 16,0 mm	57-4350-16
Ø 17,0 mm	57-4350-17
Ø 18,0 mm	57-4350-18
Ø 19,0 mm	57-4350-19
Ø 20,0 mm	57-4350-20
Ø 21,0 mm	57-4350-21
Ø 22,0 mm	57-4350-22
Ø 23,0 mm	57-4350-23
Ø 24,0 mm	57-4350-24
Ø 25,0 mm	57-4350-25
Ø 26,0 mm	57-4350-26



HEGAR
 18,5 cm, 7¹/₄"

Ø 1,5 mm	57-4351-01
Ø 2,5 mm	57-4351-02
Ø 3,5 mm	57-4351-03
Ø 4,5 mm	57-4351-04
Ø 5,5 mm	57-4351-05
Ø 6,5 mm	57-4351-06
Ø 7,5 mm	57-4351-07
Ø 8,5 mm	57-4351-08
Ø 9,5 mm	57-4351-09
Ø 10,5 mm	57-4351-10
Ø 11,5 mm	57-4351-11
Ø 12,5 mm	57-4351-12
Ø 13,5 mm	57-4351-13
Ø 14,5 mm	57-4351-14
Ø 15,5 mm	57-4351-15
Ø 16,5 mm	57-4351-16
Ø 17,5 mm	57-4351-17



205 x 105 x 45 mm

HEGAR
57-4350-99
 Satz, Set, Juego, Set
 Ø 1,0 - Ø 26,0
 (26 dilators)

HEGAR
57-4350-98
 Satz, Set, Juego, Set
 Ø 4,0 - Ø 17,0
 (14 dilators)



HEGAR
 20,0 cm, 8"

Ø 1,0 / 2,0 mm	57-4354-01
Ø 3,0 / 4,0 mm	57-4354-03
Ø 5,0 / 6,0 mm	57-4354-05
Ø 7,0 / 8,0 mm	57-4354-07
Ø 9,0 / 10,0 mm	57-4354-09
Ø 11,0 / 12,0 mm	57-4354-11
Ø 13,0 / 14,0 mm	57-4354-13
Ø 15,0 / 16,0 mm	57-4354-15
Ø 17,0 / 18,0 mm	57-4354-17
Ø 19,0 / 20,0 mm	57-4354-19
Ø 21,0 / 22,0 mm	57-4354-21
Ø 23,0 / 24,0 mm	57-4354-23
Ø 25,0 / 26,0 mm	57-4354-25



HEGAR
57-4354-98
 Satz, Set, Juego, Set
 Ø 3,0 / 4,0 - Ø 17,0 / 18,0 mm
 (8 dilators)

HEGAR
57-4354-99
 Satz, Set, Juego, Set
 Ø 1,0 / 2,0 - Ø 25,0 / 26,0 mm
 (13 dilators)



HANK

Ø 4,5 / 5,0 mm	57-4360-05
Ø 5,5 / 6,0 mm	57-4360-06
Ø 6,5 / 7,0 mm	57-4360-07
Ø 7,5 / 8,0 mm	57-4360-08
Ø 8,5 / 9,0 mm	57-4360-09
Ø 9,5 / 10,0 mm	57-4360-10

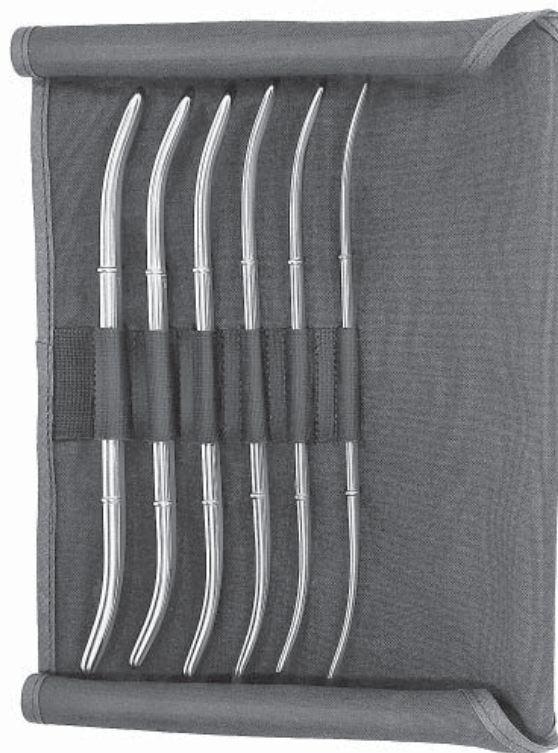

HANK
57-4360-98
 Satz, Set, Juego, Set
 Ø 4,5 / 5,0 - Ø 9,5 / 10,0 mm
 (6 dilators)

Uterus-Dilatatoren, Hakenzangen
Uterine Dilators, Uterine Tenaculum Forceps
Dilatadores uterinos, Pinzas para coger el cuello del útero
Dilatatori uterini, Pinze per abbassare il collo del'utero



Ø 4,5 / 5,0 mm	57-4370-05
Ø 5,5 / 6,0 mm	57-4370-06
Ø 7,5 / 8,0 mm	57-4370-08
Ø 8,5 / 9,0 mm	57-4370-09
Ø 9,5 / 10,0 mm	57-4370-10
Ø 11,5 / 12,0 mm	57-4370-12
Ø 12,5 / 13,0 mm	57-4370-13
Ø 13,5 / 14,0 mm	57-4370-14

PRATT



PRATT
57-4370-98
 Satz, Set, Juego, Set
 Ø 4,5 / 5,0 - Ø 13,5 / 14,0 mm
 (8 dilators)



BARRETT
 18,0 cm, 7"
57-4410-18

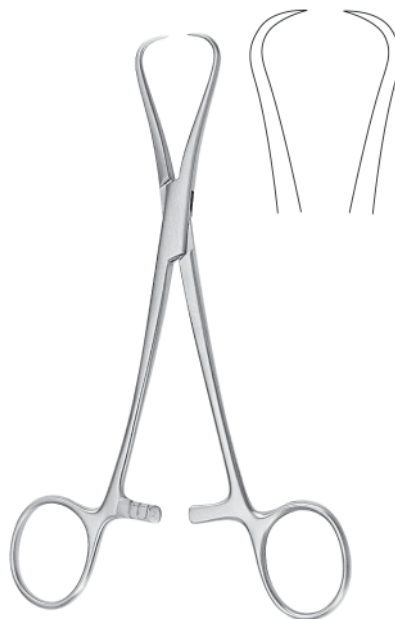

ADAIR
 19,0 cm, 7½"
57-4412-19



STAUDE-MOORE
 17,0 cm, 6¾"
57-4414-17

Hakenzangen
Uterine Tenaculum Forceps
Pinzas para coger el cuello del útero
Pinze per abbassare il collo dell'utero

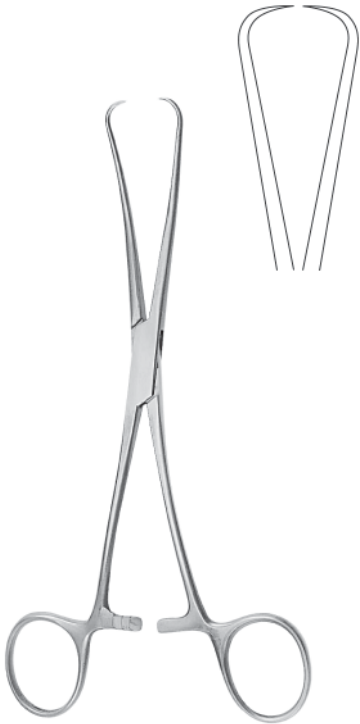

JARCHO
 20,0 cm, 8"
 57-4417-20



SCHROEDER
 25,0 cm, 9³/₄"
 57-4400-25



BRAUN
 25,0 cm, 9³/₄"
 57-4404-25



DUPLAY
 28,0 cm, 11"
 57-4419-28



POZZI
 26,0 cm, 10¹/₄"
 57-4402-26



KAHN
 24,0 cm, 9¹/₂"
 57-4421-24

Hakenzangen
Uterine Tenaculum Forceps
Pinzas para coger el cuello del útero
Pinze per abbassare il collo dell'utero



SKENE
 24,0 cm, 9½"
 57-4423-24



SCHROEDER
 24,0 cm, 9½"
 57-4426-24



SCHROEDER
 24,0 cm, 9½"
 57-4429-24



TEALE
 23,0 cm, 9"
 57-4431-23



JACOBS
 21,0 cm, 8½"
 57-4434-21



JACOBS
 21,0 cm, 8½"
 57-4435-21

Hakenzangen
Uterine Tenaculum Forceps
Pinzas para coger el cuello del útero
Pinze per abbassare il collo dell'utero

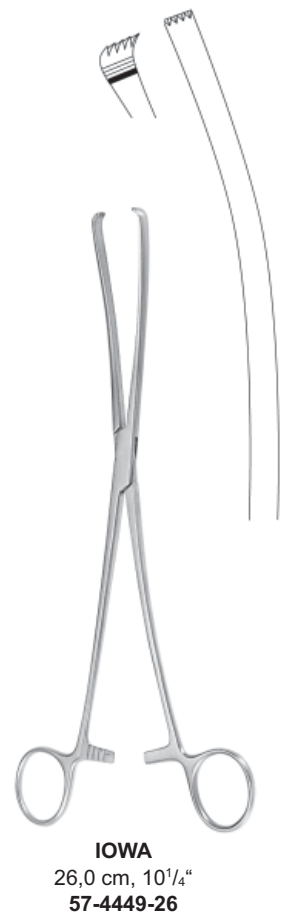
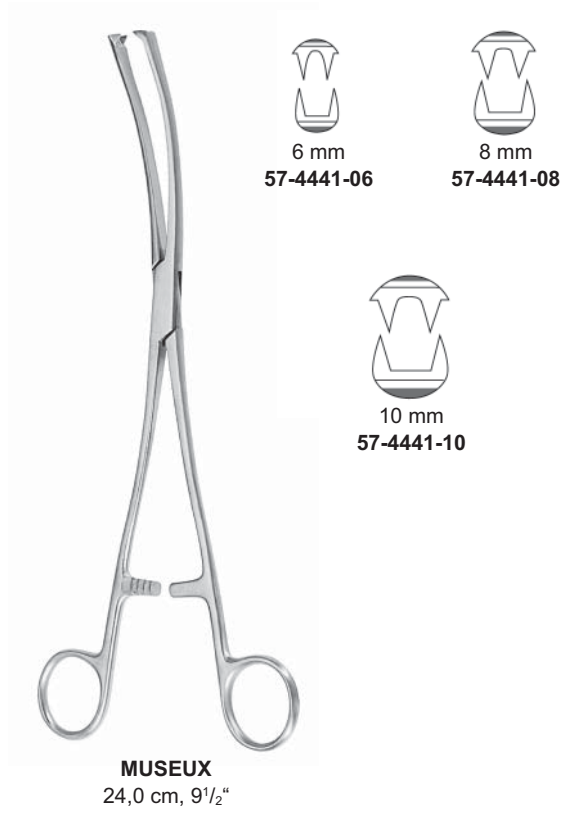
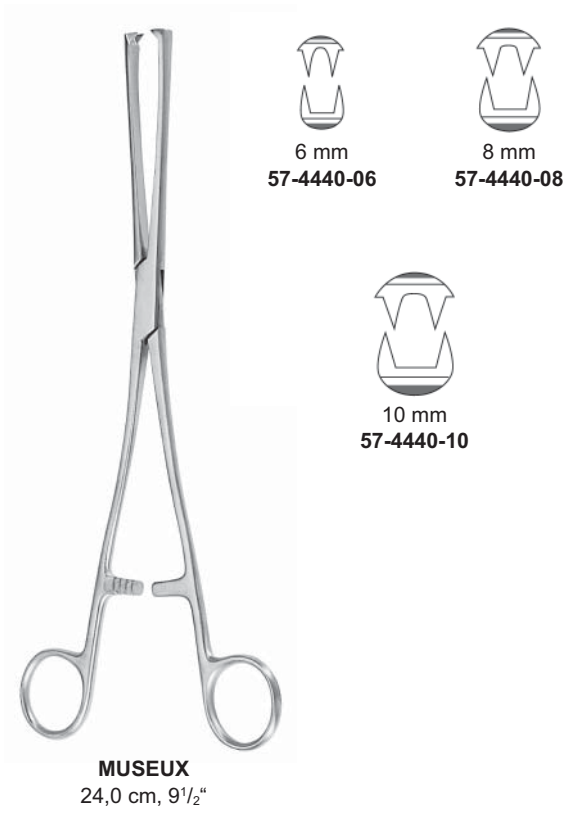

Polypen- und Ovarienzangen, Uterusfaßzangen
 Polypus and Ovum Forceps, Uterine Elevating Forceps
 Pinzas para pólipos uterinos y ovarios, Pinzas para la útero
 Pinze per polipi e ovaie, Pinze per affarrare l'utero



DOYEN
 20,5 cm, 8"
 57-4470-20

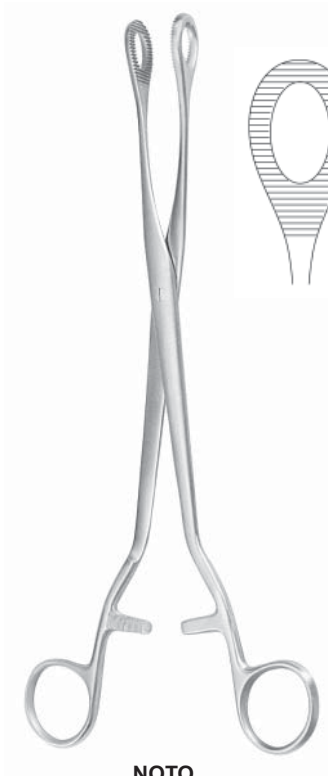

NOTO
 27,0 cm, 10⁵/₈"
 57-4472-27

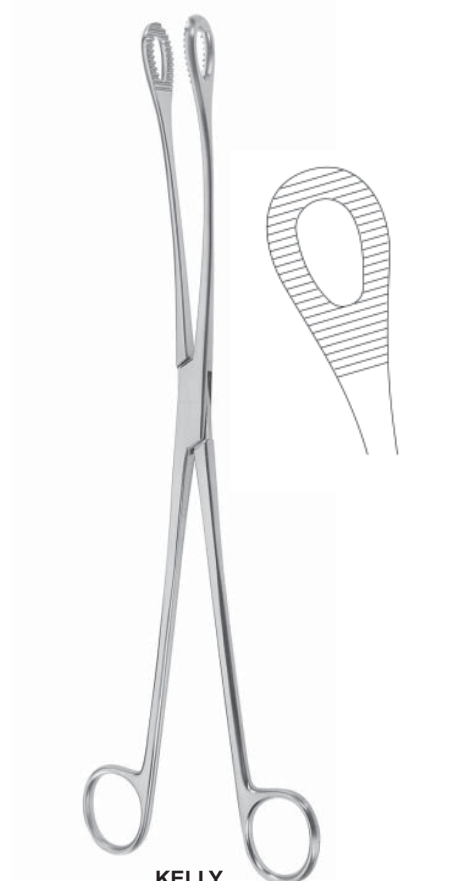

KELLY
 32,0 cm, 12¹/₂"
 57-4475-32



HEYWOOD-SMITH
 25,0 cm, 9³/₄"
 57-4480-25



DARTIGUES
 27,0 cm, 10³/₄"
 57-4482-27



SOMER
 23,0 cm, 9"
 57-4485-23

Uterusfaßzangen, Uterussonden, Zentimetereinteilung
Uterine Elevating Forceps, Uterine Probes, graduated in centimeters
Pinzas para la útero, Histerómetros, graduado en centímetros
Pinze per affarrare l'utero, Isterometri, graduato in cm



COLLIN
 25,0 cm, 9³/₄"
 57-4488-25



BEACHAM
 26,0 cm, 10¹/₄"
 57-4500-26

Amniotom
 Amniotome
 Amniótomo
 Amniotomo

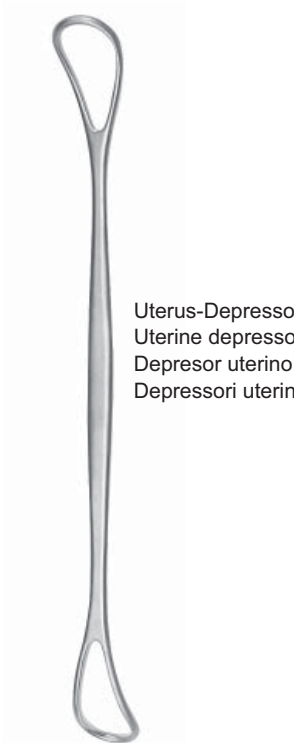

BRAUN
 28,0 cm, 11"
 57-4502-28

Uterus-Depressor
 Uterine depressor
 Depresor uterino
 Depressori uterini



SIMS
 32,0 cm, 12¹/₂"
 57-4510-32



SIMS
 32,0 cm, 12¹/₂"
 57-4511-32

biegsam
 malleable
 maleable
 malleabile



MARTIN
 32,0 cm, 12¹/₂"
 57-4516-32



MARTIN
 32,0 cm, 12¹/₂"
 57-4518-32

biegsam
 malleable
 maleable
 malleabile



VALLEIX
 25,0 cm, 10"
 57-4521-25

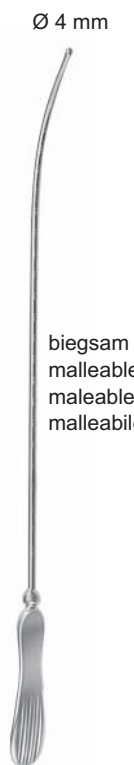

SIMPSON
 29,0 cm, 11¹/₂"
 57-4527-29

Ø 4 mm

biegsam
 malleable
 maleable
 malleabile



COLLIN
 28,0 cm, 11"
 57-4529-28

Ø 4 mm

Biopsieküretten
Biopsy Currettes
Curetas para biopsia
Curette per biopsia



KEVORKIAN
 30,0 cm, 12"
 57-4540-30



KEVORKIAN
 30,0 cm, 12"
 57-4542-30



KEVORKIAN
 30,0 cm, 12"
 57-4543-30

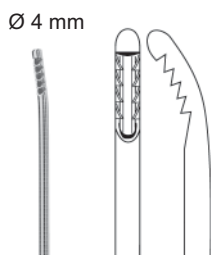

NOVAK
 23,0 cm, 9"
 57-4550-04

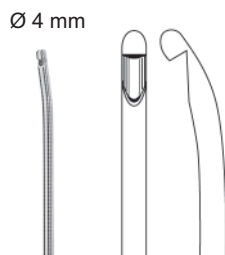

RANDALL
 23,0 cm, 9"
 57-4552-04



MILAN
 29,0 cm, 11½"

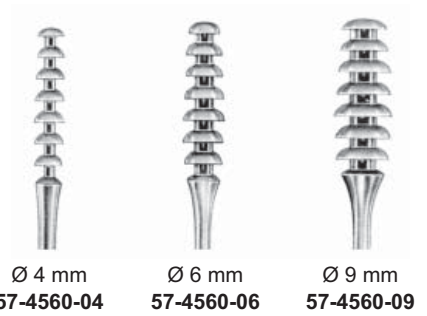

Myominstrumente
Myoma Instruments
Instrumentos para mioma
Strumenti per fibroma



25,0 cm, 9³/₄"
57-4570-25



25,0 cm, 9³/₄"
57-4572-25



SIMON
 22,0 cm, 8⁵/₈"
57-4574-22



EMMETT
 22,0 cm, 8⁵/₈"



57-4576-01



57-4576-02



57-4576-03



57-4576-04



57-4576-05



SEGOND
 27,0 cm, 10⁵/₈"
57-4580-27

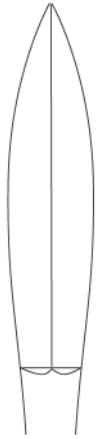

AYRE
 23,0 cm, 9"
57-4583-23

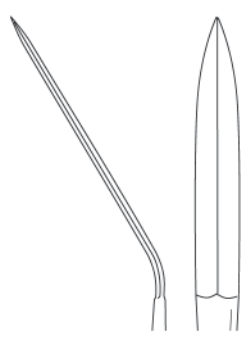

DOYEN
 19,0 cm, 7¹/₂"
57-4588-01



DOYEN
 17,0 cm, 6³/₄"
57-4588-02

Uterusküretten
Uterine Curettes
Curetas uterinas
Curette uterine

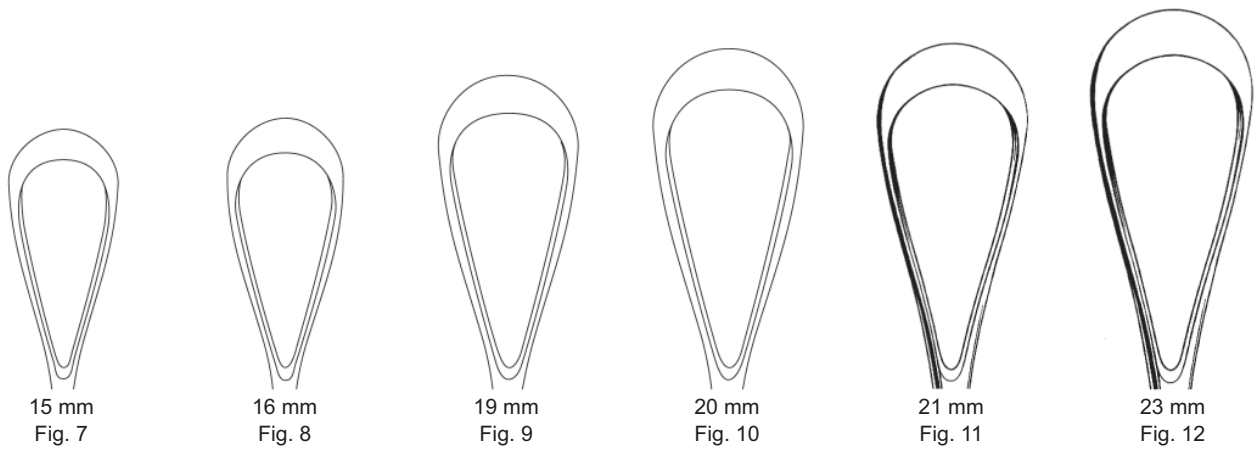
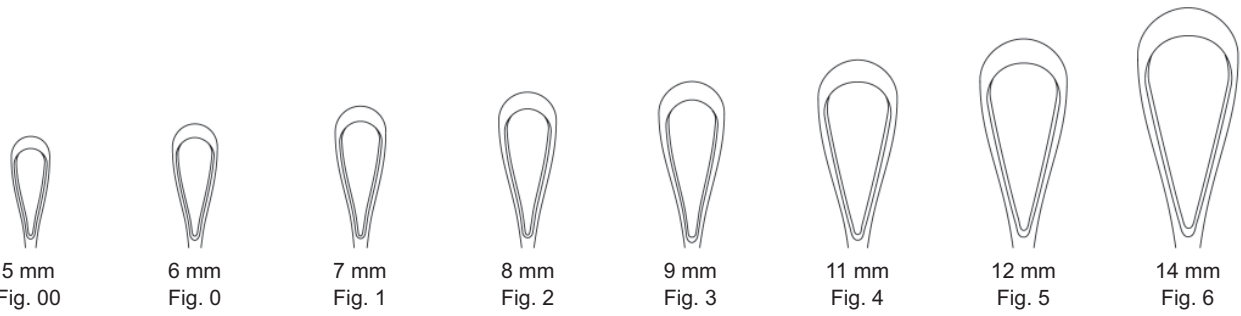

scharf, fest
 sharp, rigid
 cortantes, rígidas
 acute, rigide

Fig. 00	57-4700-05
Fig. 0	57-4700-06
Fig. 1	57-4700-07
Fig. 2	57-4700-08
Fig. 3	57-4700-09
Fig. 4	57-4700-11
Fig. 5	57-4700-12
Fig. 6	57-4700-14
Fig. 7	57-4700-15
Fig. 8	57-4700-16
Fig. 9	57-4700-19
Fig. 10	57-4700-20
Fig. 11	57-4700-21
Fig. 12	57-4700-23

RECAMIER
 26,0 cm, 10¹/₄"



scharf, biegsam
 sharp, malleable
 cortantes, maleable
 acute, malleabile

Fig. 00	57-4701-05
Fig. 0	57-4701-06
Fig. 1	57-4701-07
Fig. 2	57-4701-08
Fig. 3	57-4701-09
Fig. 4	57-4701-11
Fig. 5	57-4701-12
Fig. 6	57-4701-14
Fig. 7	57-4701-15
Fig. 8	57-4701-16
Fig. 9	57-4701-19
Fig. 10	57-4701-20
Fig. 11	57-4701-21
Fig. 12	57-4701-23

RECAMIER
 26,0 cm, 10¹/₄"

**Uterusküretten
Uterine Curettes
Curetas uterinas
Curette uterine**

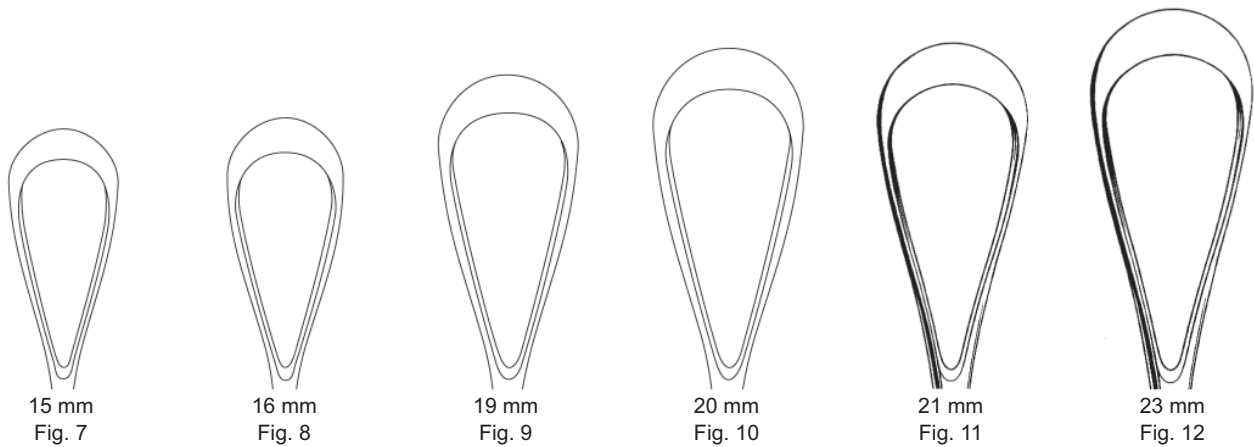
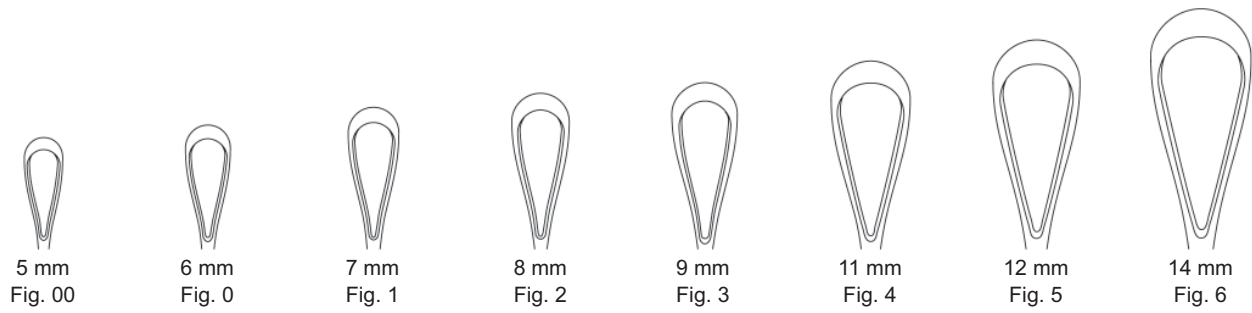

scharf, fest
sharp, rigid
cortantes, rígidas
acute, rigide

Fig. 00	57-4702-05
Fig. 0	57-4702-06
Fig. 1	57-4702-07
Fig. 2	57-4702-08
Fig. 3	57-4702-09
Fig. 4	57-4702-11
Fig. 5	57-4702-12
Fig. 6	57-4702-14
Fig. 7	57-4702-15
Fig. 8	57-4702-16
Fig. 9	57-4702-19
Fig. 10	57-4702-20
Fig. 11	57-4702-21
Fig. 12	57-4702-23

SIMS
26,0 cm, 10¹/₄"



scharf, biegsam
sharp, malleable
cortantes, maleable
acute, malleabile

Fig. 00	57-4703-05
Fig. 0	57-4703-06
Fig. 1	57-4703-07
Fig. 2	57-4703-08
Fig. 3	57-4703-09
Fig. 4	57-4703-11
Fig. 5	57-4703-12
Fig. 6	57-4703-14
Fig. 7	57-4703-15
Fig. 8	57-4703-16
Fig. 9	57-4703-19
Fig. 10	57-4703-20
Fig. 11	57-4703-21
Fig. 12	57-4703-23

SIMS
26,0 cm, 10¹/₄"

Uterusküretten
Uterine Curettes
Curetas uterinas
Curette uterine

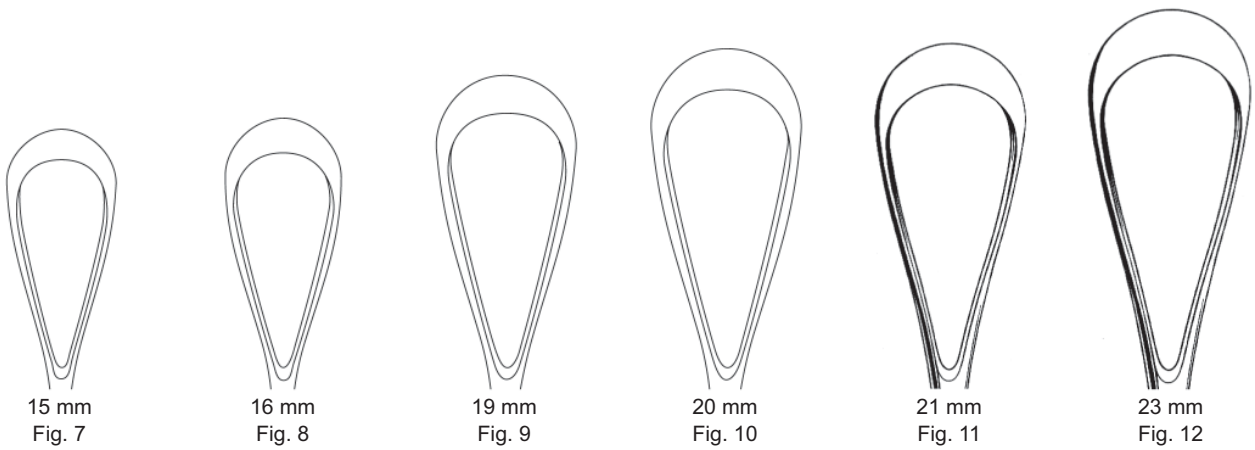
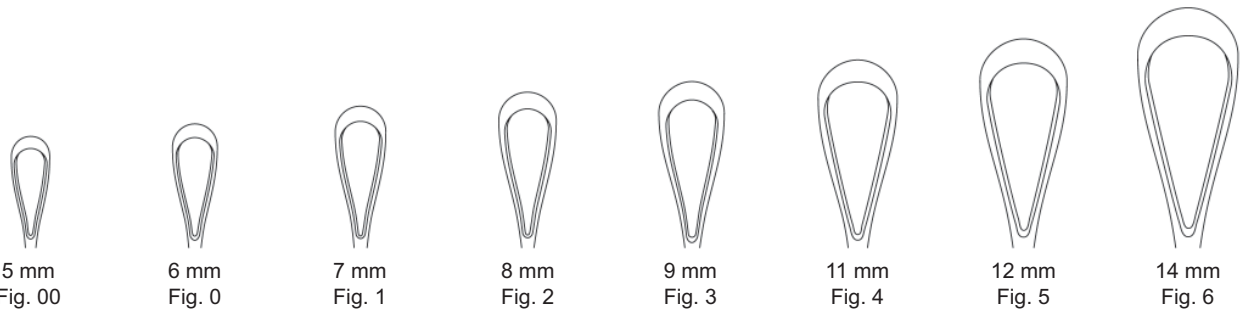

scharf, fest
 sharp, rigid
 cortantes, rígidas
 acute, rigide

Fig. 00	57-4710-05
Fig. 0	57-4710-06
Fig. 1	57-4710-07
Fig. 2	57-4710-08
Fig. 3	57-4710-09
Fig. 4	57-4710-11
Fig. 5	57-4710-12
Fig. 6	57-4710-14
Fig. 7	57-4710-15
Fig. 8	57-4710-16
Fig. 9	57-4710-19
Fig. 10	57-4710-20
Fig. 11	57-4710-21
Fig. 12	57-4710-23

RECAMIER
 31,0 cm, 12¹/₄"



scharf, biegsam
 sharp, malleable
 cortantes, maleable
 acute, malleabile

Fig. 00	57-4711-05
Fig. 0	57-4711-06
Fig. 1	57-4711-07
Fig. 2	57-4711-08
Fig. 3	57-4711-09
Fig. 4	57-4711-11
Fig. 5	57-4711-12
Fig. 6	57-4711-14
Fig. 7	57-4711-15
Fig. 8	57-4711-16
Fig. 9	57-4711-19
Fig. 10	57-4711-20
Fig. 11	57-4711-21
Fig. 12	57-4711-23

RECAMIER
 31,0 cm, 12¹/₄"

Uterusküretten
Uterine Curettes
Curetas uterinas
Curette uterine

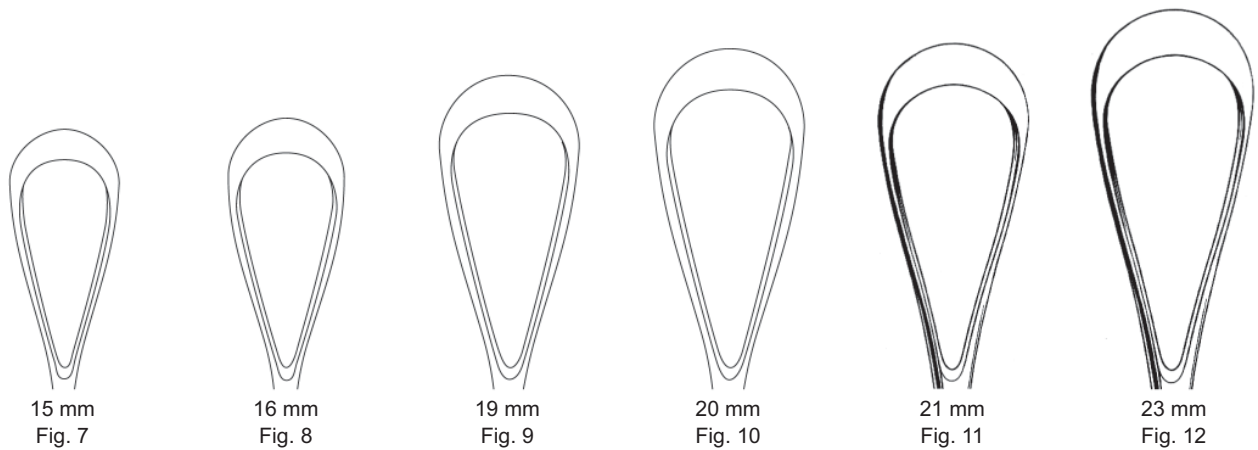
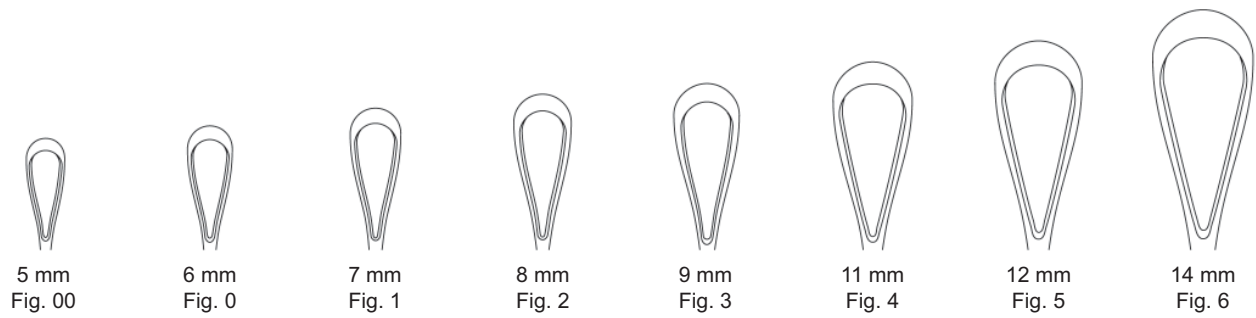

scharf, fest
 sharp, rigid
 cortantes, rígidas
 acute, rigide

Fig. 00	57-4712-05
Fig. 0	57-4712-06
Fig. 1	57-4712-07
Fig. 2	57-4712-08
Fig. 3	57-4712-09
Fig. 4	57-4712-11
Fig. 5	57-4712-12
Fig. 6	57-4712-14
Fig. 7	57-4712-15
Fig. 8	57-4712-16
Fig. 9	57-4712-19
Fig. 10	57-4712-20
Fig. 11	57-4712-21
Fig. 12	57-4712-23

SIMS
 31,0 cm, 12 1/4"



scharf, biegsam
 sharp, malleable
 cortantes, maleable
 acute, malleabile

Fig. 00	57-4713-05
Fig. 0	57-4713-06
Fig. 1	57-4713-07
Fig. 2	57-4713-08
Fig. 3	57-4713-09
Fig. 4	57-4713-11
Fig. 5	57-4713-12
Fig. 6	57-4713-14
Fig. 7	57-4713-15
Fig. 8	57-4713-16
Fig. 9	57-4713-19
Fig. 10	57-4713-20
Fig. 11	57-4713-21
Fig. 12	57-4713-23

SIMS
 31,0 cm, 12 1/4"

Uterusküretten
Uterine Curettes
Curetas uterinas
Curette uterine



30 mm
Fig. 1



35 mm
Fig. 2

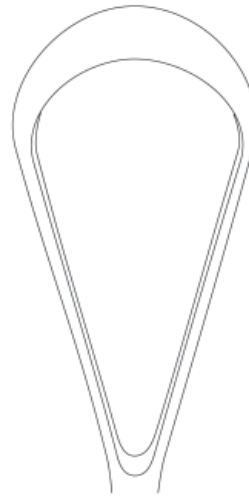

40 mm
Fig. 3



scharf, fest
sharp, rigid
cortantes, rígidas
acute, rigide

Fig. 1 **57-4720-30**
 Fig. 2 **57-4720-35**
 Fig. 3 **57-4720-40**

SIMS
31,0 cm, 12¹/₄"



scharf, biegsam
sharp, malleable
cortantes, maleable
acute, malleabile

Fig. 1 **57-4721-30**
 Fig. 2 **57-4721-35**
 Fig. 3 **57-4721-40**

SIMS
31,0 cm, 12¹/₄"

Uterusküretten
Uterine Curettes
Curetas uterinas
Curette uterine



30 mm
Fig. 1

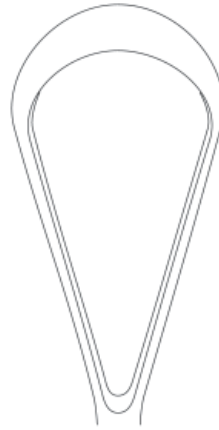

35 mm
Fig. 2

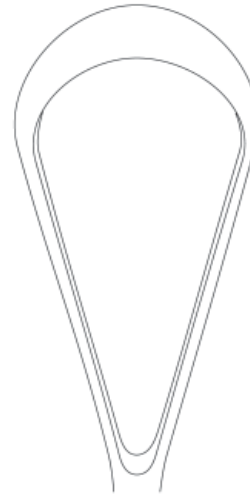

40 mm
Fig. 3



scharf, fest
sharp, rigid
cortantes, rígidas
acute, rigide

Fig. 1	57-4722-30
Fig. 2	57-4722-35
Fig. 3	57-4722-40

BUMM
31,0 cm, 12¹/₄"



scharf, biegsam
sharp, malleable
cortantes, maleable
acute, malleabile

Fig. 1	57-4723-30
Fig. 2	57-4723-35
Fig. 3	57-4723-40

BUMM
31,0 cm, 12¹/₄"

Uteruslöffel, Uterus-Biopsiezangen
Uterine Scoopes, Cervical Biopsy and Specimen Forceps
Cucharillas uterinas, Pinzas saca-bocados para biopsia
Curette uterine, Pinze per la biopsia cervicale e da prelievo



BLAKE
 27,0 cm, 10⁵/₈"
 57-4750-27



SIMON
 25,0 cm, 9³/₄"

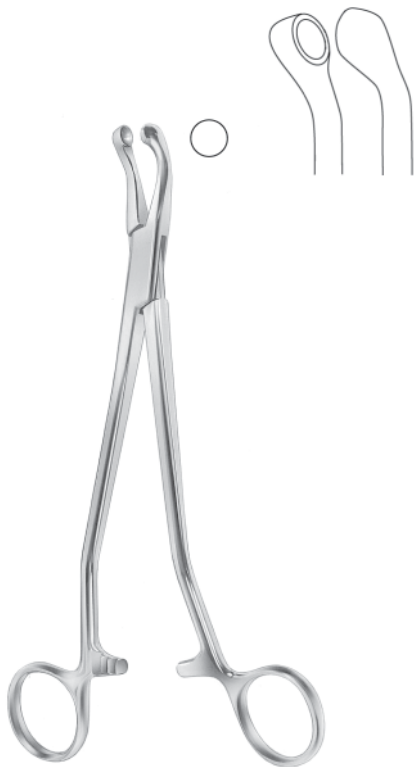
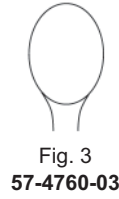
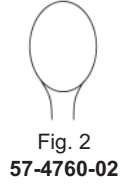
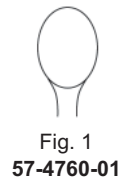

THOMS-GAYLOR
 22,0 cm, 8⁵/₈" 57-4680-22
 24,0 cm, 9¹/₂" 57-4680-24



SCHUBERT
 21,0 cm, 8¹/₄" 57-4682-21
 29,0 cm, 11¹/₂" 57-4682-29



SCHUMACHER-VAN DOREN
 24,0 cm, 9¹/₂"
 57-4684-24

Uterus-Biopsiezangen
Cervical Biopsy and Specimen Forceps
Pinzas saca-bocados para biopsia
Pinze per la biopsia cervicale e da prelievo



THOMS-GAYLOR
 24,0 cm, 9½"
 57-4686-24



FAURE
 21,0 cm, 8¼"
 57-4688-21



SCHUBERT
 26,0 cm, 10¼"
 57-4690-26

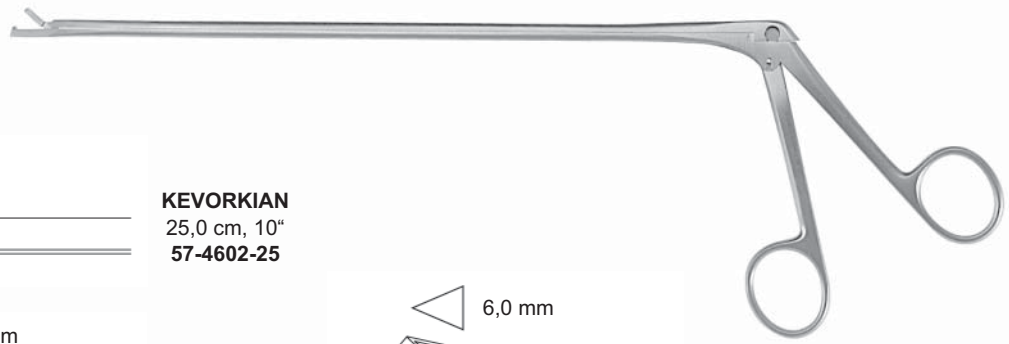

9 x 3 mm

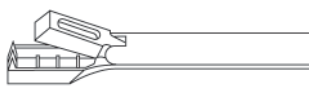

KEVORKIAN
 25,0 cm, 10"
 57-4602-25

4,5 x 8 mm

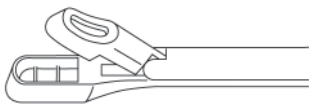

EPPENDORFER
 20,0 cm, 8"
 57-4604-20

6,0 mm

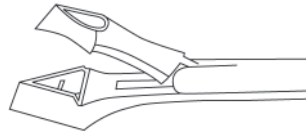

SCHUMACHER
 24,0 cm, 9½"
 57-4610-06



ALEXANDER
 28,0 cm, 11"
 57-4608-28

4,5 x 8 mm



WITTNER
 23,0 cm, 9"
 57-4615-23

4,0 mm

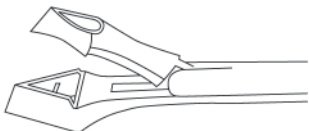

SCHUMACHER
 24,0 cm, 9½"
 57-4610-04

4,5 x 8 mm

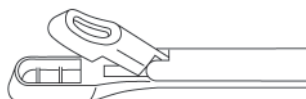

WITTNER
 23,0 cm, 9"
 57-4614-23

Uterus-Biopsiezangen
Cervical Biopsy and Specimen Forceps
Pinzas saca-bocados para biopsia
Pinze per la biopsia cervicale e da prelievo

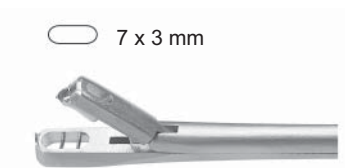
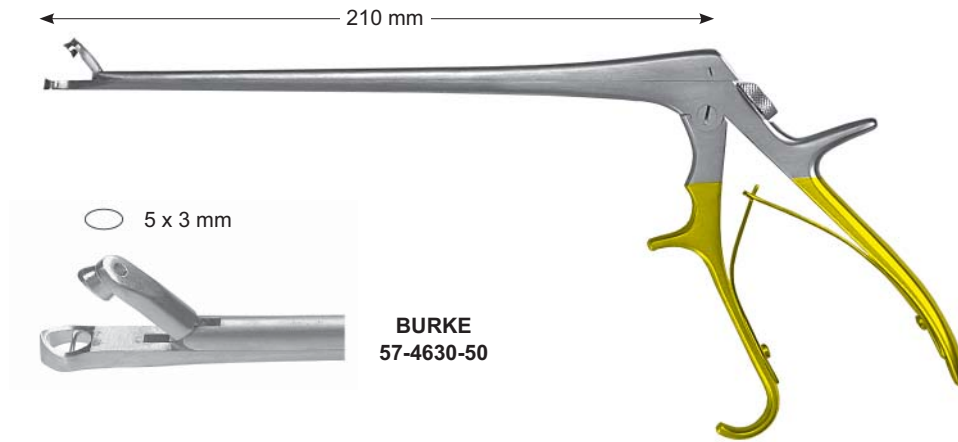

MINI-TOWNSEND
57-4630-12

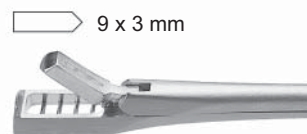

TISCHLER-KEVORKIAN
57-4630-41



BABY-TISCHLER
57-4630-14



KEVORKIAN-PACIFIC
57-4630-40

Geburtszangen
Obstetrical Forceps
Fórceps para obstétrica
Forbici per ostetricia



WRIGLEY
28,0 cm, 11"
58-4056-28



SIMPSON
30,0 cm, 11³/₄"
58-4034-30



SIMPSON-BRAUN
33,0 cm, 13"
58-4036-33



SIMPSON-BRAUN
36,0 cm, 14¹/₈"
58-4036-36



SIMPSON-LUIKART
36,0 cm, 14¹/₈"
58-4046-36



DE LEE
30,0 cm, 11³/₄"
58-4058-30



DE LEE
36,0 cm, 14¹/₈"
58-4058-36



DE LEE
38,0 cm, 15³/₈"
58-4058-38

Geburtszangen
Obstetrical Forceps
Fórceps para obstétrica
Forbici per ostetricia



MC LEAN
36,0 cm, 14¹/₈"
58-4044-36



KIELAND
41,0 cm, 16"
58-4052-41



KIELAND-LUIKART
40,0 cm, 15³/₄"
58-4054-40



PIPER
44,0 cm, 17¹/₄"
58-4060-44



ELLIOT
32,0 cm, 12¹/₂"
58-4080-32



ELLIOT
38,0 cm, 15"
58-4080-38



NAEGELE
36,0 cm, 14¹/₈"
58-4084-36



NAEGELE
40,0 cm, 15³/₄"
58-4084-40

Geburtszangen, Plazentar- und Abortuszangen
 Obstetrical Forceps, Placenta and Ovum Forceps
 Fórceps para obstétrica, Pinzas para aborto y placenta
 Forbici per ostetricia, Pinze per placenta e per ovaie



GREEN-ARMYTAGE
 21,0 cm, 8¹/₄"
 58-4200-21

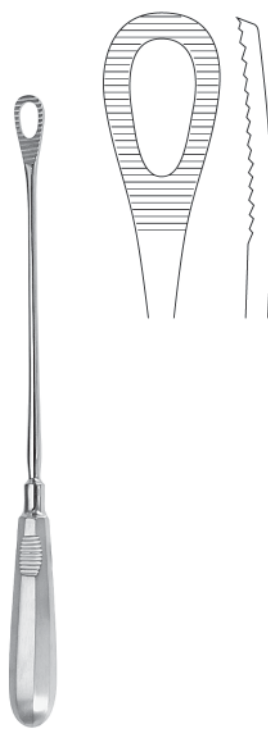

PESTALOZZA
 30,0 cm, 11³/₄"
 58-4252-30



SAENGER
 27,0 cm, 10⁵/₈"
 58-4260-27



SAENGER
 27,0 cm, 10⁵/₈"
 58-4261-27



WINTER
 28,0 cm, 11"



Fig. 1
 58-4244-01



Fig. 2
 58-4244-02



Fig. 3
 58-4244-03



Fig. 1
 58-4245-01

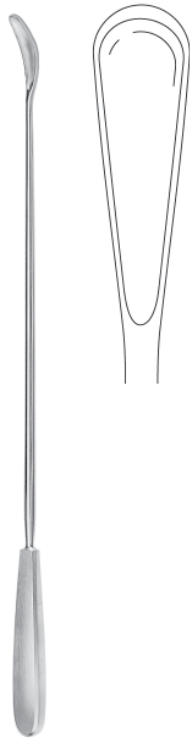

Fig. 2
 58-4245-02



Fig. 3
 58-4245-03

Plazentar- und Abortuszangen
 Placenta and Ovum Forceps
 Pinzas para aborto y placenta
 Pinze per placenta e per ovaie



WALLICH
 42,0 cm, 16½"
 58-4300-42



MARTIN
 34,0 cm, 13¾"
 58-4600-34



BIERER
 33,0 cm, 13"
 58-4236-01



BIERER
 33,0 cm, 13"
 58-4236-02



BIERER
 33,0 cm, 13"
 58-4237-01



BIERER
 33,0 cm, 13"
 58-4237-02

Vorbereitung, Dermatologie
Preparation, Dermatology
Preparación, Dermatología
Preparazione, Dermatologia



Hautstanzen, Nagel Instrumente
DermaI Punches, Nail Instruments
Trépanos cutáneos, Instrumentos para uñas
Trapani dermatici, Strumenti per unghie



Lupusküretten
 Lupus curettes
 Curetas para lupus
 Raschiatoio per lupus

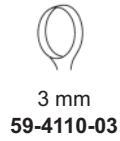

PIFFARD
 14,0 cm, 5³/₄"



KEYES
 12,0 cm, 4³/₄"

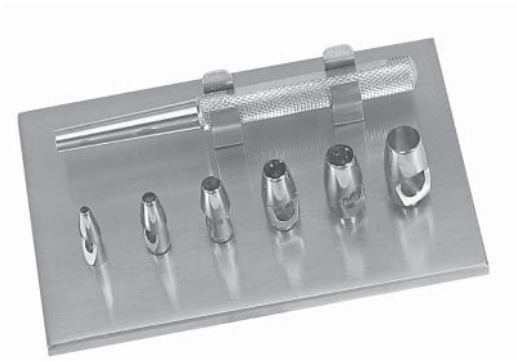
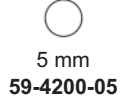
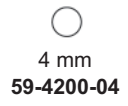
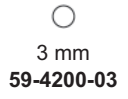
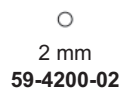

KEYES
 12,0 cm, 4³/₄"
59-4210-00

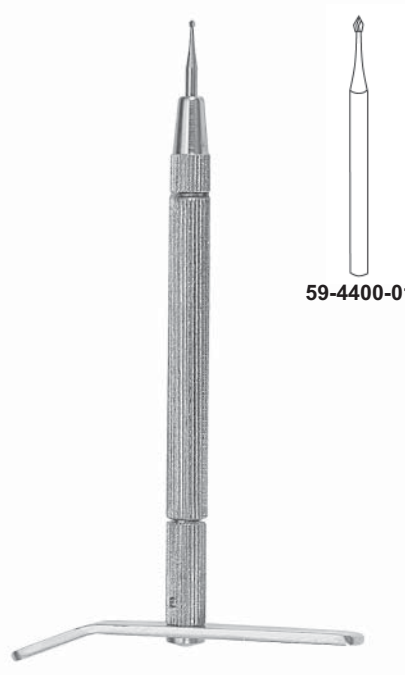

59-4400-00
 komplett, complete,
 completo, completo

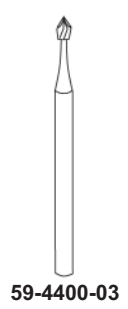
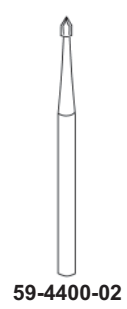
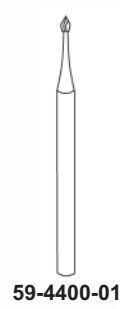

Komedonenquetscher
Comedo Extractors
Saca-comedones
Tiracomedoni



UNNA
14,0 cm, 5³/₄"
59-4000-14



UNNA
14,0 cm, 5³/₄"
59-4002-14



SAALFELD
10,0 cm, 4"
59-4010-10



SAALFELD
14,0 cm, 5³/₄"
59-4012-14



SCHAMBERG
10,0 cm, 4"
59-4020-10



WALTON
14,0 cm, 5³/₄"
59-4030-14



FOX
14,0 cm, 5³/₄"

3 mm
59-4100-03

4 mm
59-4100-04

5 mm
59-4100-05

6 mm
59-4100-06

Lupusküretten
Lupus curettes
Curetas para lupus
Raschiatoio per lupus

Nagel Instrumente
Nail Instruments
Instrumentos para uñas
Strumenti per unghie



59-4420-01

17,0 cm, 6³/₄"
 59-4420-17



59-4430-01

WALTON
 16,0 cm, 6¹/₄"
 59-4430-16



RADOLF
 13,5 cm, 5³/₈"
 59-4500-13



13,5 cm, 5³/₈"
 59-4510-13



13,0 cm, 5"
 59-4600-13

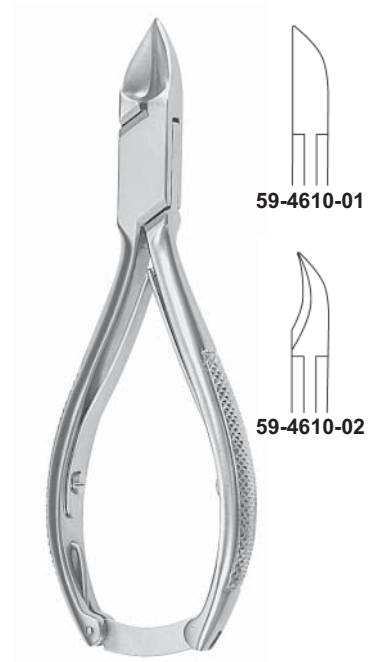

59-4610-01

59-4610-02

14,0 cm, 5¹/₂"

Knochenchirurgie
Bone Surgery
Cirurgía ósea
Chirurgia ossea



Scharfe Löffel
Bone Curettes
Cucharillas cortantes
Curetta per ossa



SCHEDE
 17,0 cm, 6³/₄"

Fig. 000
 62-4467-03

Fig. 00
 62-4467-02

Fig. 0
 62-4467-01

Fig. 1
 62-4467-11

Fig. 2
 62-4467-12

Fig. 3
 62-4467-13

Fig. 4
 62-4467-14



VOLKMANN
 17,0 cm, 6³/₄"

Fig. 0000
 62-4469-04

Fig. 000
 62-4469-03

Fig. 00
 62-4469-02

Fig. 0
 62-4469-01

Fig. 1
 62-4469-11

Fig. 2
 62-4469-12

Fig. 3
 62-4469-13

Fig. 4
 62-4469-14

Fig. 5
 62-4469-15

Fig. 6
 62-4469-16



BRUNS
 17,0 cm, 6³/₄"

Fig. 0000
 62-4472-04

Fig. 000
 62-4472-03

Fig. 00
 62-4472-02

Fig. 0
 62-4472-01

Fig. 1
 62-4472-11

Fig. 2
 62-4472-12

Fig. 3
 62-4472-13

Fig. 4
 62-4472-14

Fig. 5
 62-4472-15

Fig. 6
 62-4472-16

○
 Fig. 00000
 62-4448-04

○
 Fig. 0000
 62-4448-03

○
 Fig. 000
 62-4448-02

○
 Fig. 00
 62-4448-01

○
 Fig. 0
 62-4448-00



○
 Fig. 00
 62-4452-02

○
 Fig. 0
 62-4452-01

○
 Fig. 1
 62-4452-11



○
 Fig. 00
 62-4487-02

○
 Fig. 0
 62-4487-01

○
 Fig. 1
 62-4487-11

○
 Fig. 2
 62-4487-12

Scharfe Löffel
 Bone Curettes
 Cucharillas cortantes
 Curetta per ossa



WILLIGER
 17,0 cm, 6³/₄"

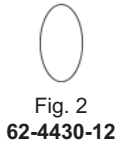

WILLIGER
 14,0 cm, 5¹/₂"



MARTINI
 14,0 cm, 5¹/₂"
62-4408-00



VOLKMANN



JANSEN
 15,0 cm, 6"
62-4411-15



JANSEN
 16,0 cm, 6¹/₄"
62-4410-16

Dissektoren, Elevatorien
 Dissectors, Elecators
 Disecadores, Elevadores
 Dissettori, Elevatori

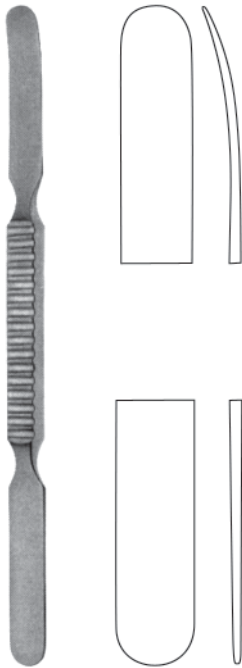

WATSON-CHEYNE
 17,5 cm, 6⁵/₈"
 63-4501-17



MC DONALD
 19,0 cm, 7¹/₂"
 63-4440-19



WILLIGER
 17,0 cm, 6³/₄"
 63-1412-17



WILLIGER
 16,0 cm, 6¹/₄"
 63-4512-16



LANGENBECK
 20,0 cm, 8"
 63-4520-08



LANGENBECK
 20,0 cm, 8"
 63-4520-10

Raspatorien
 Raspatories
 Periostótomos
 Periostotomi

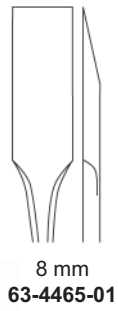

8 mm
 63-4465-01



7 mm
 63-4465-02



7 mm
 63-4465-03



7 mm
 63-4465-04



5 mm
 KÖNIG
 15,5 cm, 6"
 63-4476-15

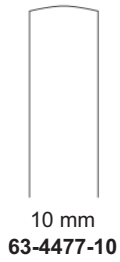

10 mm
 63-4477-10



15 mm
 63-4477-15

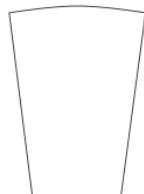

20 mm
 63-4477-20

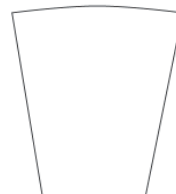

25 mm
 63-4477-25

12,5 mm



FARABEU
 15,0 cm, 6"
 63-4478-15

LAMBOTTE
 21,0 cm, 8 1/4"

Raspatorien
Raspatories
Periostótomos
Periostotomi

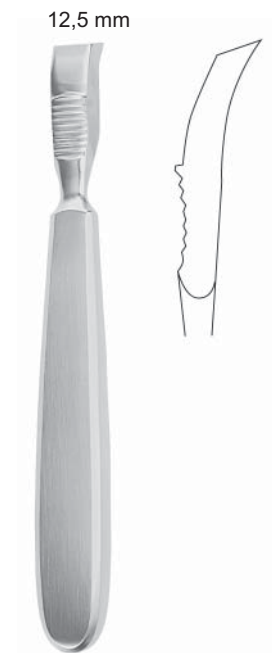

FARABEUF
 15,0 cm, 6"
 63-4479-15



LANGENBECK
 19,0 cm, 7 1/2"
 63-4472-19



SEDILLOT
 21,0 cm, 8 1/4"
 63-4488-21



4 mm	63-4480-04
6 mm	63-4480-06
8 mm	63-4480-08

WILLIGER
 16,0 cm, 6 1/4"



für Kinder
 for children
 para niños
 per bambini

DOYEN
 17,0 cm, 6 3/4"
 63-4485-17



für Kinder
 for children
 para niños
 per bambini

DOYEN
 17,0 cm, 6 3/4"
 63-4487-17



für Erwachsene
 for adults
 para adultos
 per adulti

DOYEN
 17,0 cm, 6 3/4"
 63-4481-17



für Erwachsene
 for adults
 para adultos
 per adulti

DOYEN
 17,0 cm, 6 3/4"
 63-4483-17

Flachmeißel, Hohlmeißel, Osteotome
Chisels, Gouges, Osteotomes
Cinceles, Gubias, Osteótomos
Scalpelli, Sgorbie, Osteotomi

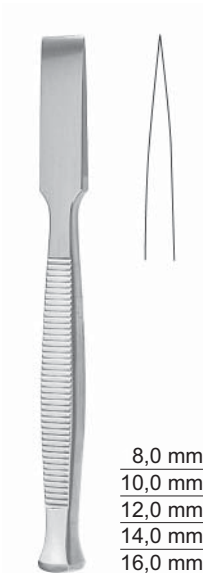

8,0 mm	64-4300-08
10,0 mm	64-4300-10
12,0 mm	64-4300-12
14,0 mm	64-4300-14
16,0 mm	64-4300-16

13,5 cm, 5³/₈"



8,0 mm	64-4301-08
10,0 mm	64-4301-10
12,0 mm	64-4301-12
14,0 mm	64-4301-14
16,0 mm	64-4301-16

13,5 cm, 5³/₈"



8,0 mm	64-4302-08
10,0 mm	64-4302-10
12,0 mm	64-4302-12
14,0 mm	64-4302-14
16,0 mm	64-4302-16

13,5 cm, 5³/₈"



3,0 mm	64-4334-03
4,0 mm	64-4334-04
5,0 mm	64-4334-05
6,0 mm	64-4334-06

PARTSCH
13,5 cm, 5³/₈"



3,0 mm	64-4336-03
4,0 mm	64-4336-04
5,0 mm	64-4336-05
6,0 mm	64-4336-06

PARTSCH
13,5 cm, 5³/₈"



10,0 mm	64-4361-10
15,0 mm	64-4361-15
20,0 mm	64-4361-20
25,0 mm	64-4361-25

STILLE
20,0 cm, 8"

Flachmeißel, Hohlmeißel, Osteotome
 Chisels, Gouges, Osteotomes
 Cinceles, Gubias, Osteótomos
 Scalpelli, Sgorbie, Osteotomi

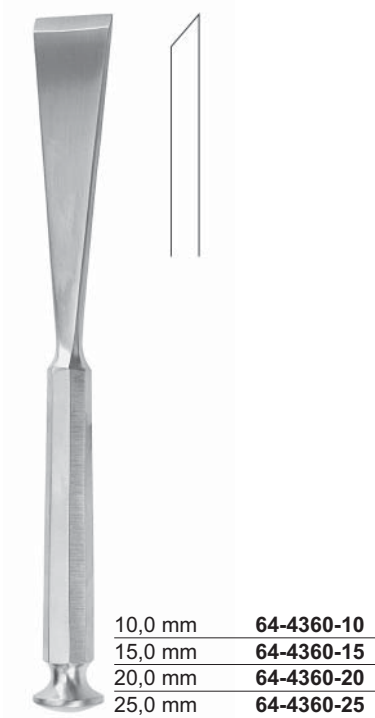

STILLE
 20,0 cm, 8"



STILLE
 20,0 cm, 8"

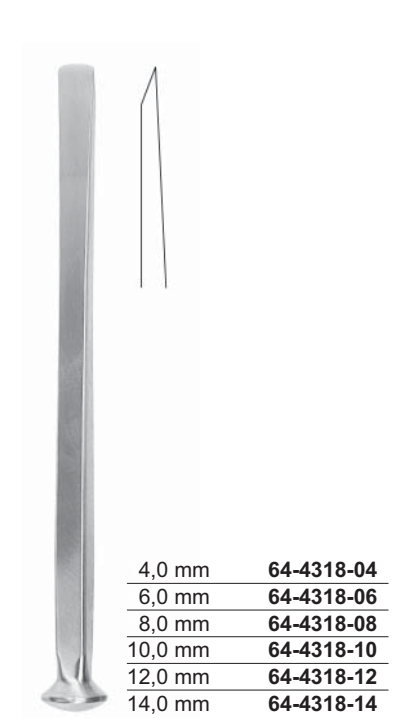

ALEXANDER
 18,0 cm, 7"



ALEXANDER
 18,0 cm, 7"



SMITH-PETERSEN
 20,0 cm, 8"



SMITH-PETERSEN
 20,0 cm, 8"

Flachmeißel, Hohlmeißel, Osteotome, Hämmer
 Chisels, Gouges, Osteotomes, Mallets
 Cinceles, Gubias, Osteótomos, Martillos
 Scalpelli, Sgorbie, Osteotomi, Martelli



9,0 mm	64-4352-09
14,0 mm	64-4352-14
16,0 mm	64-4352-16
19,0 mm	64-4352-19
25,0 mm	64-4352-25

SMITH-PETERSEN
 20,0 cm, 8"



9,0 mm	64-4353-09
14,0 mm	64-4353-14
16,0 mm	64-4353-16
19,0 mm	64-4353-19
25,0 mm	64-4353-25

SMITH-PETERSEN
 20,0 cm, 8"



6,0 mm	64-4450-06
15,0 mm	64-4450-15
20,0 mm	64-4450-20
25,0 mm	64-4450-25
30,0 mm	64-4450-30
38,0 mm	64-4450-38
44,0 mm	64-4450-44
50,0 mm	64-4450-50

LAMBOTTE
 24,0 cm, 9 1/2"



6,0 mm	64-4451-06
15,0 mm	64-4451-15
20,0 mm	64-4451-20
25,0 mm	64-4451-25
30,0 mm	64-4451-30
38,0 mm	64-4451-38
44,0 mm	64-4451-44
50,0 mm	64-4451-50

LAMBOTTE
 24,0 cm, 9 1/2"



COLLIN
 20,0 cm, 8"
 61-4132-20



PARTSCH
 18,0 cm, 7"
 61-4145-18



BERGMANN
 24,0 cm, 9 1/2"
 61-4201-24

Sterilisation
Sterilization
Esterilización
Sterilizzazione



Sterilisierzangen
Sterilizing Forceps
Pinzas para esterilización
Pinze per sterilizzazione



20,0 cm, 8"
76-4160-20



CHEATTLE
27,0 cm, 10⁵/₈"
76-4163-27



ROGGE
23,0 cm, 9"
76-4164-23



PYE-SMITH (HARRISON)
30,0 cm, 12"
76-4166-30



MAYO
14,0 cm, 5¹/₂"
76-4151-14



BUNT
12,0 cm, 4³/₄"
76-4154-12



Ø 75 x 130 mm	76-4142-06
Ø 75 x 175 mm	76-4142-07
Ø 100 x 175 mm	76-4142-08
Ø 100 x 200 mm	76-4142-09



Ø 40,0 mm	76-4130-04
Ø 60,0 mm	76-4130-06
Ø 80,0 mm	76-4130-08
Ø 100,0 mm	76-4130-10
Ø 120,0 mm	76-4130-12
Ø 150,0 mm	76-4130-15



165 x 55 mm	0,75 l	76-4133-00
175 x 70 mm	1,00 l	76-4133-10
225 x 100 mm	2,00 l	76-4133-20
240 x 95 mm	2,75 l	76-4133-30
260 x 120 mm	4,00 l	76-4133-40
290 x 100 mm	5,00 l	76-4133-50
315 x 150 mm	5,50 l	76-4133-60
325 x 135 mm	8,00 l	76-4133-70
360 x 165 mm	12,00 l	76-4133-80
415 x 150 mm	14,00 l	76-4133-90



170 mm	76-4140-17
250 mm	76-4140-25
275 mm	76-4140-27

Schalen
Trays
Bandejas
Bacinelle



200 x 150 x 25 mm	76-4200-01
260 x 180 x 30 mm	76-4200-02
300 x 220 x 30 mm	76-4200-03
350 x 220 x 40 mm	76-4200-04
220 x 170 x 50 mm	76-4200-05
280 x 200 x 50 mm	76-4200-06
320 x 240 x 50 mm	76-4200-07
370 x 270 x 50 mm	76-4200-08
420 x 320 x 50 mm	76-4200-09



76-4300-00

Ø 65 x 17 mm

Außen- und Innendose

Exterior and interior box

Caja exterior e interior

Scatola esterna es interiore

76-4300-01

Ø 62 x 13 mm

Innendose allein

Interior box only

Caja interior, suelta

Scatola interiore sola



25 ccm
76-4310-25



50 ccm
76-4310-50

**Bürstenspender
Brush Dispensers
Distribuidores de cepillos
Distributori di spazzole**

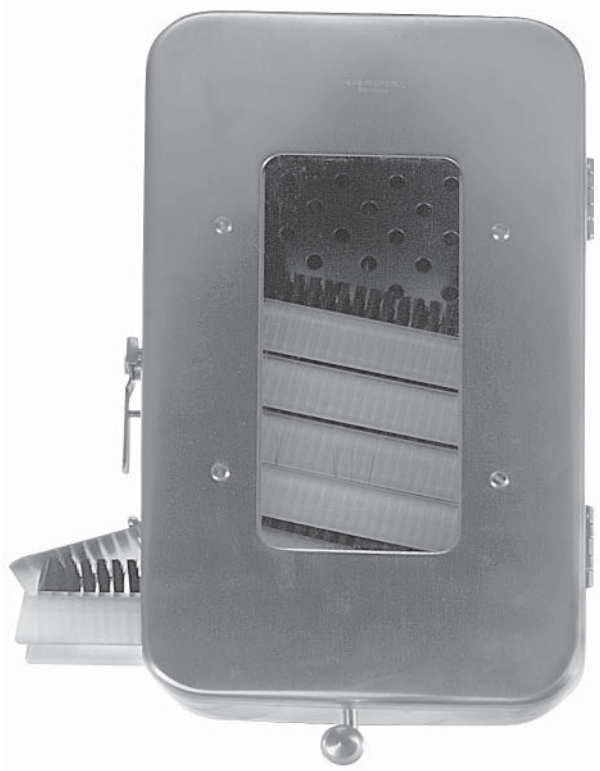

Bürstenspender für 10 Bürsten
Brush dispenser for 10 brushes
Distribuidor de cepillos para 10 cepillos
Distributore per 10 spazzole
260 x 155 x 65 mm
76-4800-01

Bürstenspender für 20 Bürsten
Brush dispenser for 20 brushes
Distribuidor de cepillos para 20 cepillos
Distributore per 20 spazzole
270 x 240 x 65 mm
76-4800-02



76-4800-10

mehr als 400x autoklavierbar
more than 400 times autoclavable
esterilizable más de 400 veces en autoclave
sterilizzabile piú di 400 volte in autoclave

